

INSTRUCTION MANUAL



TurfWeather Weather Station

Revision: 11/15



Copyright © 2004-2015
Campbell Scientific, Inc.

Limited Warranty

“Products manufactured by CSI are warranted by CSI to be free from defects in materials and workmanship under normal use and service for twelve months from the date of shipment unless otherwise specified in the corresponding product manual. (Product manuals are available for review online at www.campbellsci.com.) Products not manufactured by CSI, but that are resold by CSI, are warranted only to the limits extended by the original manufacturer. Batteries, fine-wire thermocouples, desiccant, and other consumables have no warranty. CSI’s obligation under this warranty is limited to repairing or replacing (at CSI’s option) defective Products, which shall be the sole and exclusive remedy under this warranty. The Customer assumes all costs of removing, reinstalling, and shipping defective Products to CSI. CSI will return such Products by surface carrier prepaid within the continental United States of America. To all other locations, CSI will return such Products best way CIP (port of entry) per Incoterms ® 2010. This warranty shall not apply to any Products which have been subjected to modification, misuse, neglect, improper service, accidents of nature, or shipping damage. This warranty is in lieu of all other warranties, expressed or implied. The warranty for installation services performed by CSI such as programming to customer specifications, electrical connections to Products manufactured by CSI, and Product specific training, is part of CSI’s product warranty. **CSI EXPRESSLY DISCLAIMS AND EXCLUDES ANY IMPLIED WARRANTIES OF MERCHANTABILITY OR FITNESS FOR A PARTICULAR PURPOSE. CSI hereby disclaims, to the fullest extent allowed by applicable law, any and all warranties and conditions with respect to the Products, whether express, implied or statutory, other than those expressly provided herein.”**

Assistance

Products may not be returned without prior authorization. The following contact information is for US and international customers residing in countries served by Campbell Scientific, Inc. directly. Affiliate companies handle repairs for customers within their territories. Please visit www.campbellsci.com to determine which Campbell Scientific company serves your country.

To obtain a Returned Materials Authorization (RMA), contact CAMPBELL SCIENTIFIC, INC., phone (435) 227-9000. After an application engineer determines the nature of the problem, an RMA number will be issued. Please write this number clearly on the outside of the shipping container. Campbell Scientific's shipping address is:

CAMPBELL SCIENTIFIC, INC.

RMA# _____
815 West 1800 North
Logan, Utah 84321-1784

For all returns, the customer must fill out a "Statement of Product Cleanliness and Decontamination" form and comply with the requirements specified in it. The form is available from our web site at www.campbellsci.com/repair. A completed form must be either emailed to repair@campbellsci.com or faxed to (435) 227-9106. Campbell Scientific is unable to process any returns until we receive this form. If the form is not received within three days of product receipt or is incomplete, the product will be returned to the customer at the customer's expense. Campbell Scientific reserves the right to refuse service on products that were exposed to contaminants that may cause health or safety concerns for our employees.

Safety

DANGER — MANY HAZARDS ARE ASSOCIATED WITH INSTALLING, USING, MAINTAINING, AND WORKING ON OR AROUND TRIPODS, TOWERS, AND ANY ATTACHMENTS TO TRIPODS AND TOWERS SUCH AS SENSORS, CROSSARMS, ENCLOSURES, ANTENNAS, ETC. FAILURE TO PROPERLY AND COMPLETELY ASSEMBLE, INSTALL, OPERATE, USE, AND MAINTAIN TRIPODS, TOWERS, AND ATTACHMENTS, AND FAILURE TO HEED WARNINGS, INCREASES THE RISK OF DEATH, ACCIDENT, SERIOUS INJURY, PROPERTY DAMAGE, AND PRODUCT FAILURE. TAKE ALL REASONABLE PRECAUTIONS TO AVOID THESE HAZARDS. CHECK WITH YOUR ORGANIZATION'S SAFETY COORDINATOR (OR POLICY) FOR PROCEDURES AND REQUIRED PROTECTIVE EQUIPMENT PRIOR TO PERFORMING ANY WORK.

Use tripods, towers, and attachments to tripods and towers only for purposes for which they are designed. Do not exceed design limits. Be familiar and comply with all instructions provided in product manuals. Manuals are available at www.campbellsci.com or by telephoning (435) 227-9000 (USA). You are responsible for conformance with governing codes and regulations, including safety regulations, and the integrity and location of structures or land to which towers, tripods, and any attachments are attached. Installation sites should be evaluated and approved by a qualified engineer. If questions or concerns arise regarding installation, use, or maintenance of tripods, towers, attachments, or electrical connections, consult with a licensed and qualified engineer or electrician.

General

- Prior to performing site or installation work, obtain required approvals and permits. Comply with all governing structure-height regulations, such as those of the FAA in the USA.
- Use only qualified personnel for installation, use, and maintenance of tripods and towers, and any attachments to tripods and towers. The use of licensed and qualified contractors is highly recommended.
- Read all applicable instructions carefully and understand procedures thoroughly before beginning work.
- Wear a **hardhat** and **eye protection**, and take **other appropriate safety precautions** while working on or around tripods and towers.
- **Do not climb** tripods or towers at any time, and prohibit climbing by other persons. Take reasonable precautions to secure tripod and tower sites from trespassers.
- Use only manufacturer recommended parts, materials, and tools.

Utility and Electrical

- **You can be killed** or sustain serious bodily injury if the tripod, tower, or attachments you are installing, constructing, using, or maintaining, or a tool, stake, or anchor, come in **contact with overhead or underground utility lines**.
- Maintain a distance of at least one-and-one-half times structure height, 20 feet, or the distance required by applicable law, **whichever is greater**, between overhead utility lines and the structure (tripod, tower, attachments, or tools).
- Prior to performing site or installation work, inform all utility companies and have all underground utilities marked.
- Comply with all electrical codes. Electrical equipment and related grounding devices should be installed by a licensed and qualified electrician.

Elevated Work and Weather

- Exercise extreme caution when performing elevated work.
- Use appropriate equipment and safety practices.
- During installation and maintenance, keep tower and tripod sites clear of un-trained or non-essential personnel. Take precautions to prevent elevated tools and objects from dropping.
- Do not perform any work in inclement weather, including wind, rain, snow, lightning, etc.

Maintenance

- Periodically (at least yearly) check for wear and damage, including corrosion, stress cracks, frayed cables, loose cable clamps, cable tightness, etc. and take necessary corrective actions.
- Periodically (at least yearly) check electrical ground connections.

WHILE EVERY ATTEMPT IS MADE TO EMBODY THE HIGHEST DEGREE OF SAFETY IN ALL CAMPBELL SCIENTIFIC PRODUCTS, THE CUSTOMER ASSUMES ALL RISK FROM ANY INJURY RESULTING FROM IMPROPER INSTALLATION, USE, OR MAINTENANCE OF TRIPODS, TOWERS, OR ATTACHMENTS TO TRIPODS AND TOWERS SUCH AS SENSORS, CROSSARMS, ENCLOSURES, ANTENNAS, ETC.

Table of Contents

PDF viewers: These page numbers refer to the printed version of this document. Use the PDF reader bookmarks tab for links to specific sections.

1. Introduction	1
2. Precautions	1
3. Initial Inspection	1
4. QuickStart Guide	2
4.1 Computer Requirements	2
4.2 TurfWeather Setup Procedure	2
4.3 Radio Setup	9
4.4 Help and Support	11
5. Installation	11
5.1 Power Sources	11
5.2 Site Selection	11
5.3 Communications Considerations	12
5.3.1 Direct Communications	12
5.3.1.1 Cable Lengths	12
5.3.1.2 Grounding Issues	12
5.3.2 Wireless Communications	13
5.3.2.1 Transmission Ranges	13
5.3.2.2 Line-of-Sight	13
5.3.2.3 Testing Radio Transmissions	14
5.3.2.4 Appropriate Update Interval Settings for Wireless Systems	14
5.4 Installation Procedures	15
5.4.1 Assemble the 16776 Tripod	15
5.4.2 Ground Installations	16
5.4.3 16772 Guy-Wire Kit Installation	17
5.4.4 Mounting the TurfWeather Station on a Tripod or Pole	18
5.4.5 SP5 Solar Panel Installation	21
5.4.6 16775 Ground Kit Installation	22
5.4.7 Base Radio and Standard Antenna Installation	24
5.4.8 High Gain Base Station Antenna Installation	25
5.4.9 17342 Short-Haul Modem Installation	28
5.4.10 Auxiliary Battery Unit Installation Procedure	30
5.4.11 ATP100 Auxiliary Telemetry and Power Unit Installation Procedure	34
6. Maintenance	40
6.1 Solar Panel pn SP5	40
6.2 Battery Pack pn 14159	40
6.3 Temperature/Relative Humidity Sensor pn 14144	41
6.4 Solar Radiation Sensor pn 14009	41
6.5 Rain Gage pn 25585	41
6.6 Wind Speed Sensor pn 14010	41

6.7	Wind Direction Sensor pn 14011	41
6.8	Memory Battery pn 15598	42
6.9	Equipment Removal and Replacement	42
6.9.1	Removing the TurfWeather Station from the Mast or Pole.....	42
6.9.2	Battery Pack Replacement Procedure	42
6.9.3	Temperature/Relative Humidity Sensor Assembly Replacement Procedure	45
6.9.4	Solar Radiation Sensor Replacement Procedure	47
6.9.5	Rain Gage Replacement Procedure.....	50
6.9.6	Wind Speed Sensor (Anemometer) Replacement Procedure	52
6.9.7	Wind Direction Sensor Replacement Procedure	54
6.9.8	Memory Battery Replacement Procedure	56
6.9.9	Main Electronics Board (Motherboard) Replacement Procedure	58
6.9.10	Spread Spectrum Radio (all frequencies) Replacement Procedure	60

Appendix

A. TurfWeather Equipment..... A-1

A.1	Communications Options	A-1
A.1.1	17394 Serial-to-USB Adapter	A-1
A.2	Power Supplies.....	A-1
A.2.1	16851 5 W Solar Panel Kit.....	A-1
A.2.2	16876 AC Converter	A-2
A.3	Mounting/Installation Kits	A-3
A.3.1	16776 Tripod/Mast Assembly	A-3
A.3.2	16770 Tripod Installation Kit.....	A-3
A.3.3	16773—Tripod Stake Kit.....	A-4
A.3.4	16771—Tripod Mast Extension	A-4
A.3.5	16772—Tripod Guy-wire Kit.....	A-5
A.3.6	16775—Tripod Grounding Kit.....	A-6

Figures

4-1.	Box of standard and wireless equipment. The lift straps allow easy removal of the weather station from the box.	2
4-2.	Serial cable (left) and the weather station serial port in which the serial cable male connector connects	3
4-3.	Keyed power switch is located on the bottom of the TurfWeather	3
4-4.	The surface mount antenna is often used for the base station	9
4-5.	A Yagi antenna used with TurfWeather station	9
4-6.	Radio connections. The serial cable connects to the RS-232 port and the AC adapter connects to the Power port.....	10
5-1.	Example of Ten Times the Height Rule	12
5-2.	Line-of-sight example	14
5-3.	The 16776 Tripod/Mast Assembly includes the nut and bolt (left) used to attach each foot to the tripod	15
5-4.	Mast extension (left) and mast extension inserted into the tripod mast.....	15
5-5.	The mast fits in the center of the tripod.....	16
5-6.	Temporary sites use stakes included in the 16773 Tripod Stake Kit (left) driven through the center hole in each tripod foot (right)	17
5-7.	The TurfWeather weather station assembly properly seated on a mast or pole.....	19

5-8. Two views of the TurfWeather station. The U-bolt and nuts are shown.....19

5-9. Accurate wind direction measurements require the reference line on the wind direction sensor (right) to be aligned with Magnetic North.....20

5-10. The bubble level (in red box) confirms the station is level, which is required for accurate rainfall and solar radiation measurements20

5-11. Remove the red or green cap.....21

5-12. The ground lug connected to the bottom of the weather station.....22

5-13. The right close up is the 14 AWG wire and the #4 cable attached to the tripod coupling.....23

5-14. The #4 cable connected to the ground rod23

5-15. A typical RF401-series base station25

5-16. Short haul enclosure mounted to the 16776 tripod.....29

5-17. Cables connected to enclosure for short haul modem30

5-18. Short haul modem cables connected to TurfWeather station30

5-19. Yellow wire connected to Battery+ terminal32

5-20. Auxiliary battery enclosure mounted to the 16776 tripod.....33

5-21. 18971 cable connected to auxiliary battery enclosure.....33

5-22. 18971 cable connected to TurfWeather station34

5-23. ATP100 enclosure and TurfWeather station mounted to pole35

5-24. Yellow wire connected to Battery+ terminal37

5-25. Auxiliary battery enclosure mounted to the 16776 tripod.....38

5-26. 18971 cable and 31654 RS-232 cable connected to ATP100 enclosure.....39

5-27. 18971 cable and 31654 RS-232 cable connected to TurfWeather station39

5-28. 7.0 Amp Hour Battery properly installed40

6-1. Inside of the TurfWeather44

6-2. Main electronic board44

6-3. Removing the temperature and RH sensor cover46

6-4. Solar radiation sensor48

6-5. Top view of rain gage50

6-6. Wind speed sensor with boot down and exposing wires52

6-7. Wind direction sensor with boot down and exposing wires54

6-8. Memory battery inside TurfWeather station57

6-9. Main electronics board inside TurfWeather station59

6-10. Radio fastened to the main electronics board with a Velcro strap61

6-11. Removing the Velcro strap.....62

TurfWeather Weather Station

1. Introduction

Campbell Scientific's TurfWeather® is an automated weather station designed for OEMs in the turf grass market. It consists of meteorological sensors, a solar panel or AC to DC charging source, and a protective case that houses the datalogger/transmitter and rechargeable battery. The case and solar panel mount to a pole with an outer diameter of 2.5 cm to 4.4 cm (1 in to 1.75 in).

2. Precautions

- READ AND UNDERSTAND the [Safety](#) section at the front of this manual.
- Use the lift straps to remove the weather station from the box, since removing the station by lifting on the sensors may damage the sensors (see FIGURE 4-1).
- When unpacking and installing the station, avoid resting the weather station on the wind speed and wind direction sensors.
- WARNING: Under no circumstances should installation be accomplished during inclement weather to avoid personal hazard due to lightning.
- CAUTION: Connecting an incompatible power source to your weather station voids your **Warranty**. It is advisable for you to check with your local distributor before connecting a power source not purchased with this weather station.
- The weather station uses a lead-acid battery that must be properly disposed of. Do not dispose of this battery pack in a municipal landfill, or by burning it. If you do not know where to dispose of a battery pack, then contact your local solid waste disposal site for instructions.
- CAUTION: To minimize the possibility of equipment damage or personal hazard, we strongly recommend a qualified electrician design and install the grounding system and data isolation components. Improperly grounded systems can damage host computers and equipment connected to antennas.

3. Initial Inspection

- Remove the top foam packing from the TurfWeather weather station box and verify you have all ordered equipment. Report missing or damaged equipment before installing system.

4. QuickStart Guide

4.1 Computer Requirements

- Windows Operating System: 8, 7, Vista, or XP
- Available serial port or USB port (serial-to-USB converter cable required)

4.2 TurfWeather Setup Procedure

1. Use the lift straps to remove the weather station from the box (see FIGURE 4-1).
2. Unpack the other equipment from the box.

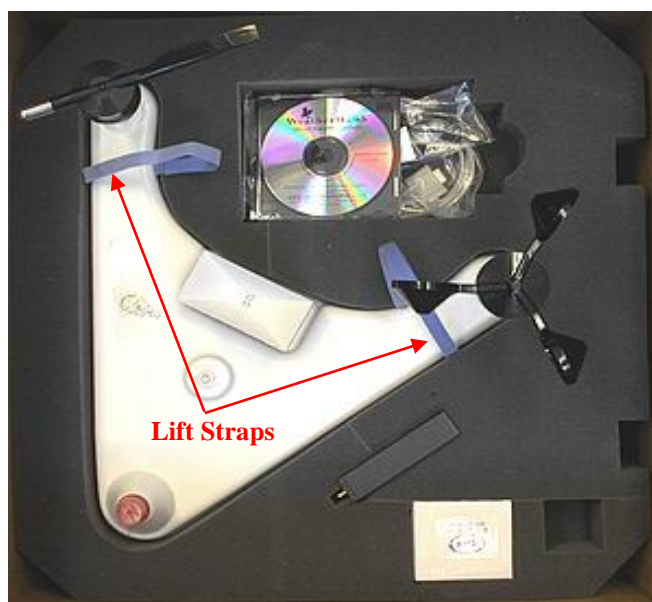


FIGURE 4-1. Box of standard and wireless equipment. The lift straps allow easy removal of the weather station from the box.

3. Install the Campbell Scientific *PC200W* Software on your computer.
4. Remove the dust cover from the TurfWeather's **RS-232** port and connect the serial cable's male connector to it (FIGURE 4-2).
5. Connect the serial cable's female connector to a computer's 9-pin serial port.



FIGURE 4-2. Serial cable (left) and the weather station serial port in which the serial cable male connector connects

NOTE

- a. Ensure the computer serial port is not already assigned to an open program.
- b. If you're connecting the cable to a USB port, a serial-to-USB converter cable is required and optionally available from Campbell Scientific pn 16878,USB-AD.

NOTE

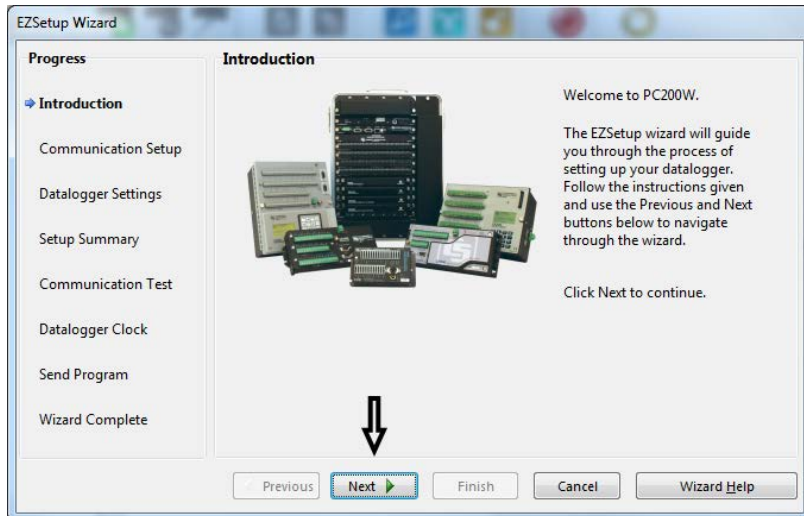
If the TurfWeather station has been configured for use with the optional external battery or ATP100, no internal battery is inside the weather station. The station will be powered from the optional external battery or the ATP100. Note that the key switch will no longer control power to the station when these options are connected to station. To power the station, connect the auxiliary battery cable (pn 18971) to the **AUXILIARY** connector on the bottom of the TurfWeather station. Then connect the battery cable to the external battery unit. Refer to Section 5.4.10, *Auxiliary Battery Unit Installation Procedure* (p. 30), but note that the internal battery has already been removed.

5. Turn the key to the on position (FIGURE 4-3). This is the power on/off switch for the weather station. The weather station will be running on battery power only at this point. Remember to turn this switch off when the charging cable is not connected to prevent damaging the battery.

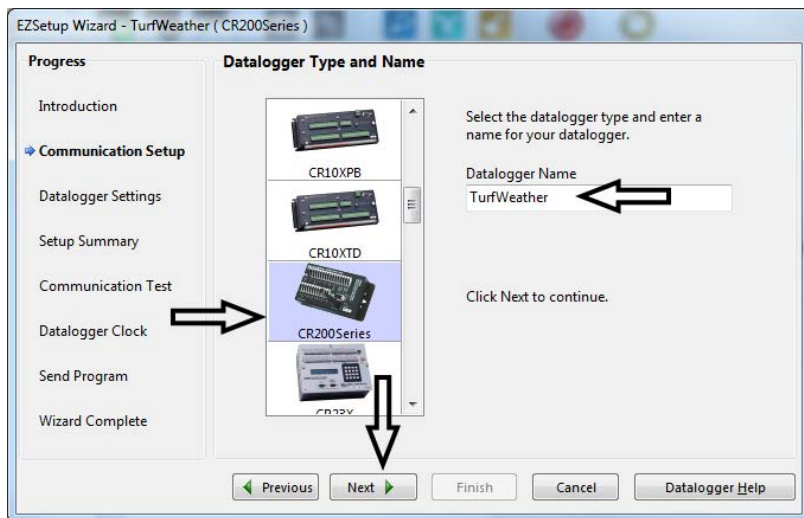


FIGURE 4-3. Keyed power switch is located on the bottom of the TurfWeather

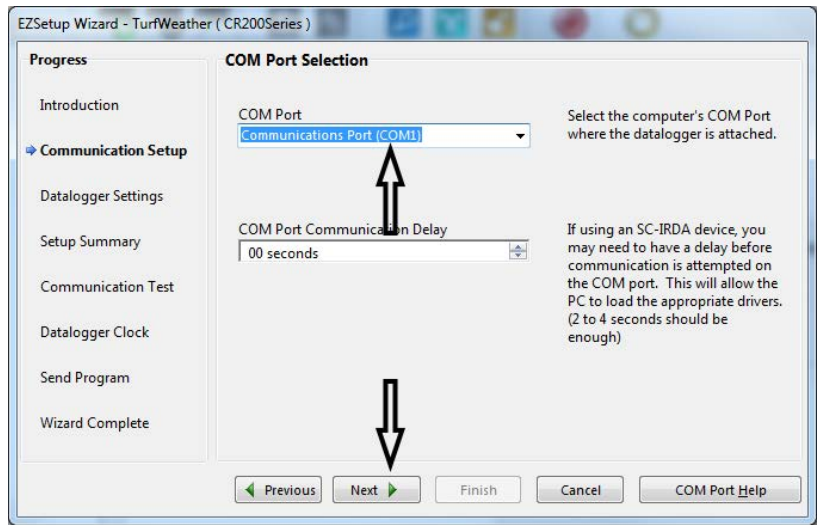
6. Load and start the Campbell Scientific *PC200W* software.
7. The first time *PC200W* opens, it will open with the **EZSetup Wizard** or it can be accessed by clicking on the *add* button. It is the green + in the top left area of the main screen.
8. Click on the **Next** button on the **Introduction** window.



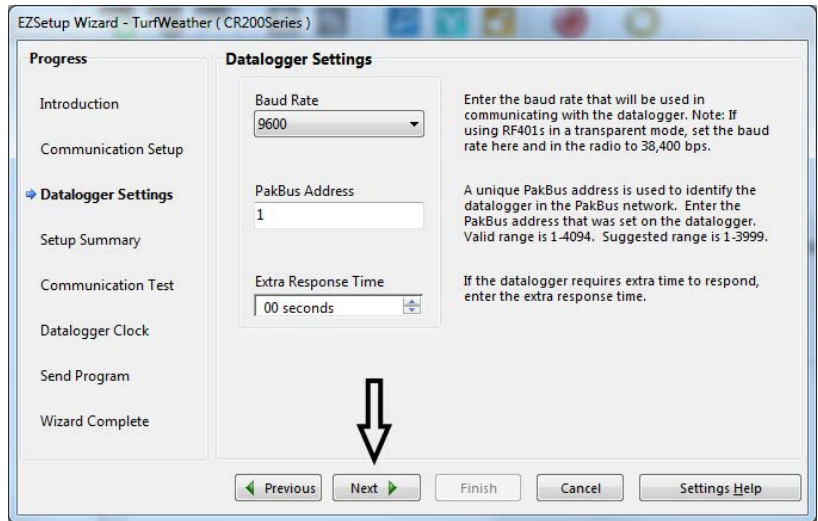
9. Select **CR200Series** from the drop down menu in the **Datalogger Type and Name** window. Select the **CR200Series** and type *TurfWeather* for the **Datalogger Name**. Click **Next**.



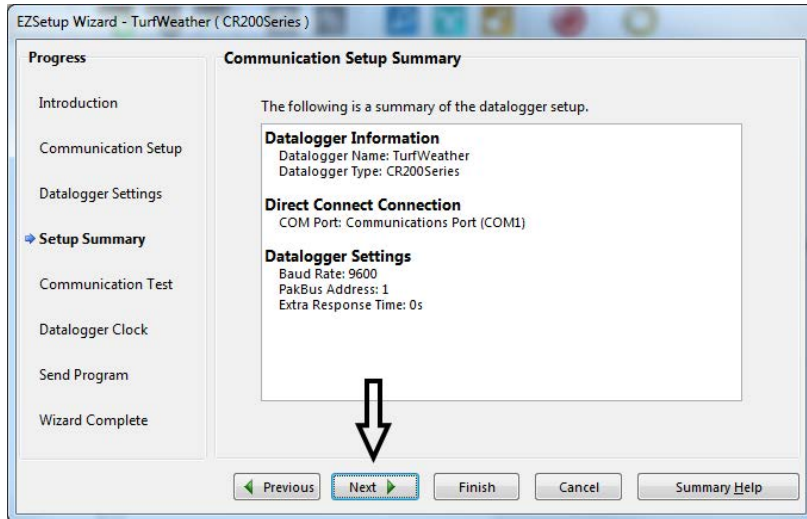
- Select the COM port used to connect to the weather station from the **COM Port** drop down box. Use the default **COM Port Communication Delay** setting of *00 seconds*, and click **Next**.



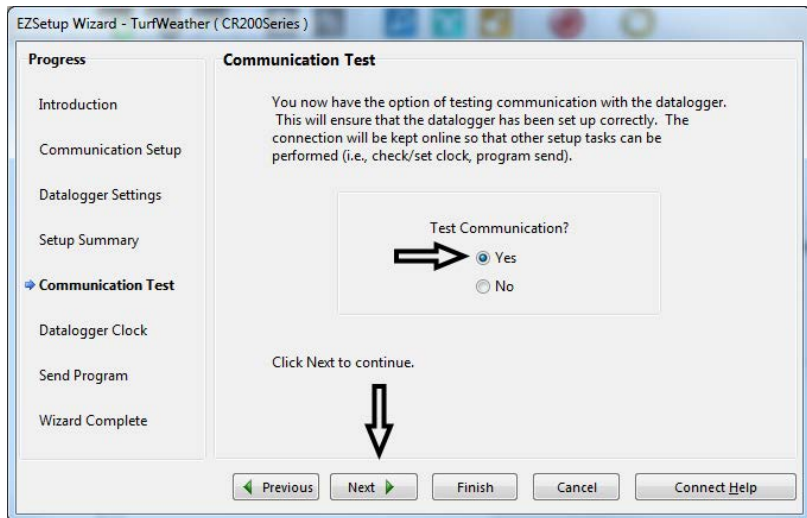
- Use the default datalogger settings, which are *9600* for the **Baud Rate**, *1* for the **PakBus Address**, and *00 seconds* the **Extra Response Time**. Click **Next**.



12. Check the information displayed in the **Communication Setup Summary**. Click **Next** if there are not any changes. If changes need to be made, then click **Previous** to go to the correct window to make the changes. After the changes have been made, click **Next** to advance back to the **Setup Summary**.

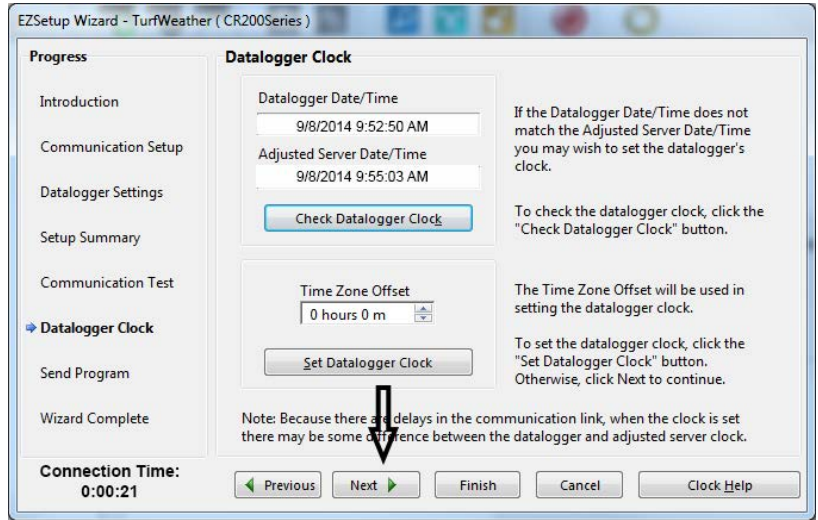


13. In the **Communication Test** window, select **Yes** and then click **Next**.

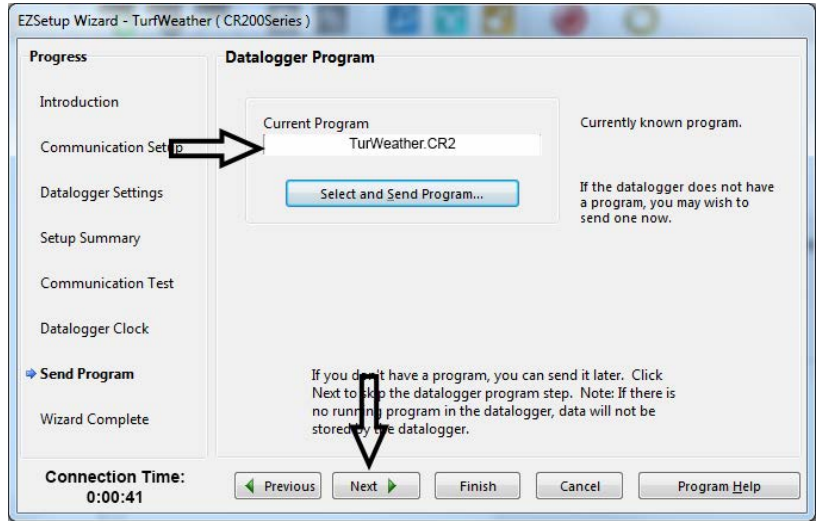


14. When the table definitions have been updated, the **Communication Test Succeeded** window will appear. This may take several minutes. Click **Next**.

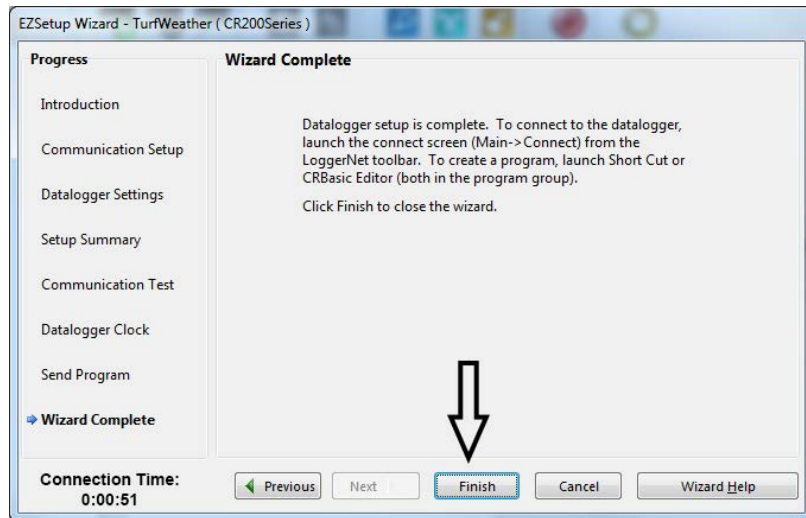
- In the **Datalogger Clock** window, click **Set Datalogger Clock** to sync the datalogger date and time with the PC if needed then click **Next**.



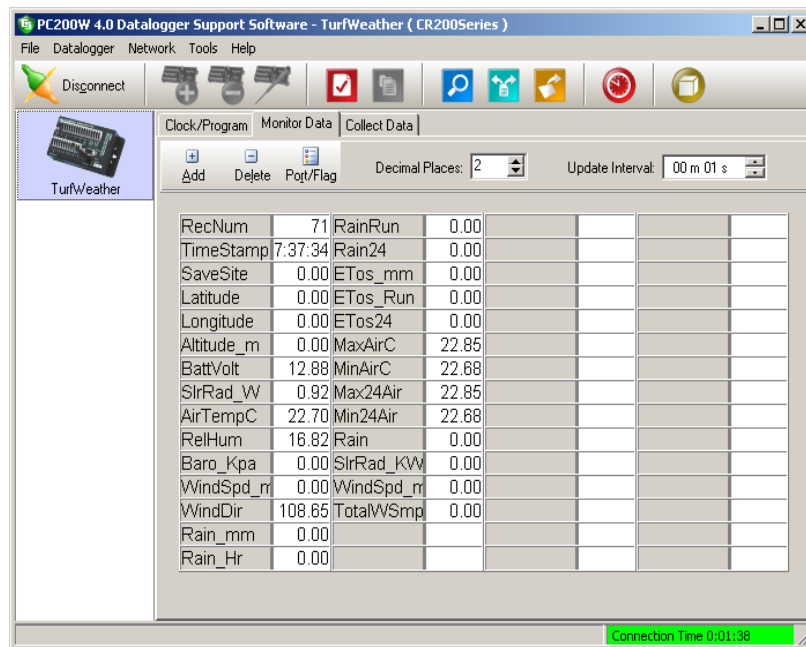
- In the **Datalogger Program** window, verify that the correct program for application is shown as **Current Program**. Click **Next**.



- In the **Wizard Complete** window, click on **Finish**, to go to the main *PC200W* window.



- From the **Main Screen**, click the **Monitor Data** tab to display the measurements from the TurfWeather weather station. The weather station is communicating and making measurements if the readings being displayed look accurate and are updating.



- If the station is communicating properly, click **Disconnect**. *PC200W* can also be used to verify communication with radios after setting them up using the procedure in Section 4.3, *Radio Setup* (p. 9).
- Proceed to Section 4.3, *Radio Setup* (p. 9), if using radio communication. If the TurfWeather station is a direct connect, move the key to the off position and proceed to Section 5, *Installation* (p. 11).

NOTE If the weather station does not function properly, contact your local distributor to solve the problem before continuing to the next steps.

4.3 Radio Setup

1. Attach the antenna or cable to the radio connector marked **Antenna**. FIGURE 4-4 and FIGURE 4-5 show antennas that can be used with the TurfWeather. In FIGURE 4-6, a whip antenna is attached to the **Antenna** connector of an RF401A radio.



FIGURE 4-4. The surface mount antenna is often used for the base station



FIGURE 4-5. A Yagi antenna used with TurfWeather station

2. Connect the serial cable male connector to the radio connector marked **RS-232** and the female connector to a computer serial port (FIGURE 4-6).



FIGURE 4-6. Radio connections. The serial cable connects to the **RS-232** port and the AC adapter connects to the **Power** port.

3. Plug the ac adapter for the RF401-series radio into a grounded ac wall outlet.
4. Connect the ac adapter's barrel connector to the **Power** connector on the RF401-series radio (FIGURE 4-6). The red **TX LED** should illuminate.

NOTE

For some RF401-series radios, the power connector is labeled **DC PWR**.

5. Start the Campbell Scientific *PC200W* software. Click on **Connect**. Click on the **Monitor Data** tab to confirm communication.
6. Monitor the sensor displays. After a few minutes, numeric values should appear if the weather station and radio are communicating. Also the LEDs on the RF401-series radio will blink.

NOTE

If the radio is not communicating properly, you may be experiencing interference from nearby equipment such as wireless phones, other spread spectrum radios, or another TurfWeather weather station. Changing some settings on your radio and weather station should rectify this situation. Contact your local distributor for assistance.

7. If your radio is working properly, close the Campbell Scientific *PC200W* software and turn the key to the off position. You are now ready to install your weather station at the site.

4.4 Help and Support

NOTE The latitude, longitude, and altitude of your site is entered into the location area when setting up the station in Weather Station software. A GPS unit, Google Earth or NOAA web sites can help provide this information. This information is used in the formula by the software to calculate evapotranspiration.

- TurfWeather Site Installation Guide
- Campbell Scientific customer support (435) 227-9082

5. Installation

Before installing your weather station at your site, read over the sections on power sources, site selection, and communications considerations. Section 5.4, *Installation Procedures (p. 15)*, provides instructions for installing your TurfWeather weather station on a tripod or pole and for installing our associated mounting/installation kits as required.

5.1 Power Sources

TurfWeather weather stations are provided with an internal sealed rechargeable lead acid battery that must be recharged to assure continued system function. For recharging the battery, Campbell Scientific offers solar panels or an AC/DC converter (see Appendix A, *TurfWeather Equipment (p. A-1)*). If no power supply has been ordered, you must provide a compatible power source that has an output rating of 18 Vdc (see Section 2, *Precautions (p. 1)*).

5.2 Site Selection

The ideal weather station site is level and well away from obstructions such as buildings, trees, and steep slopes. If obstructions exist, use the *Ten Times the Height Rule*.

In the example shown in FIGURE 5-1, if the height of the tree, T, is 6 ft and the height of the shed, H, is 7ft, then the TurfWeather station should be placed at least 80 ft from the tree (i.e., $10H = 10 \times 7 = 70$ ft).

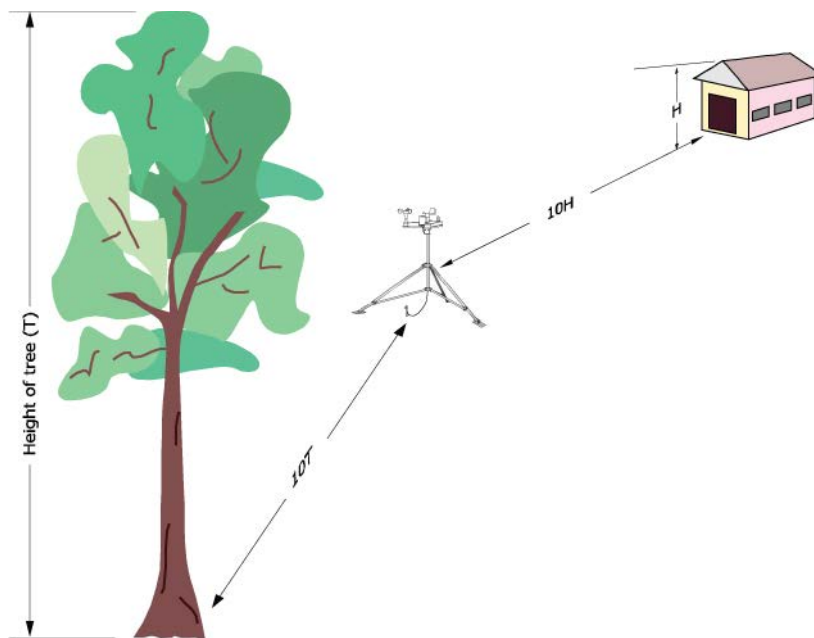


FIGURE 5-1. Example of Ten Times the Height Rule

Another option when obstructions exist is to raise the weather station height above the obstruction by using mast extensions.

NOTE

- a. If your weather station will be inside a fence to discourage vandalism, the fence top must be lower than the wind sensors even if the fence is chain-link.
- b. Accurate wind measurements require your weather station to be located at the highest point in a particular region.
- c. The tripod/mast height cannot exceed 312 cm (10 ft).

5.3 Communications Considerations

5.3.1 Direct Communications

Short haul modems enable communication between the weather station and computer over two twisted pairs of wires. This communication requires the DCE/DTE switch on the modem to be in the DTE position at the weather station, and in the DCE position at the computer.

5.3.1.1 Cable Lengths

The maximum distance between modems is determined by baud rate and wire gage. At 9600 bps, the approximate range is 3.2 km (2 miles) using 24 AWG wire.

5.3.1.2 Grounding Issues

Outdoor cables may be subject to induced currents due to lightning or other environmental factors. Therefore, proper grounding is imperative to avoid

damage to the weather station and/or the host computer. A qualified electrician should design and install the grounding system.

5.3.2 Wireless Communications

Wireless TurfWeather weather station systems use industrial grade spread spectrum radios.

5.3.2.1 Transmission Ranges

Site your TurfWeather weather station within the spread spectrum radio transmission range. Typical transmission ranges are listed below:

- Up to 0.8 km (0.5 mile) for the weather station 916 MHz and weather station 922 MHz
- Up to 0.4 km (0.25 mile) for the weather station 2.40 GHz
- Up to 11.25 km (7 mile) if an optional higher gain antenna is installed on both the weather station and the RF401-series base station

NOTE

- a. The transmission ranges assume standard weather station antennas are used at the computer site. User-supplied, higher gain antennas at the base station or on the weather station can increase the transmission range.
 - b. The ranges assume no obstructions are in the line-of-sight. Line-of-sight is defined and described below.
 - c. Other radios on the same frequency can cause interference issues.
-

5.3.2.2 Line-of-Sight

Line-of-sight is defined as a straight path between a transmitting and receiving antenna that is unobstructed by intermediate topography or obstructions. A clear line-of-sight is required to achieve the optimum transmission range. The effect of obstructions on the transmission range can vary. Therefore, if obstructions lie within the line-of-sight, you should test your radio transmissions before permanently installing your weather station (see Section 5.3.2.3, *Testing Radio Transmissions* (p. 14)).

FIGURE 5-2 is a line-of sight example. In this example, the dotted line indicates that Station 1 has a clear line-of sight with the computer site. The mountain obstructs Station 2's line-of-sight and will reduce or possibly prevent wireless communications.

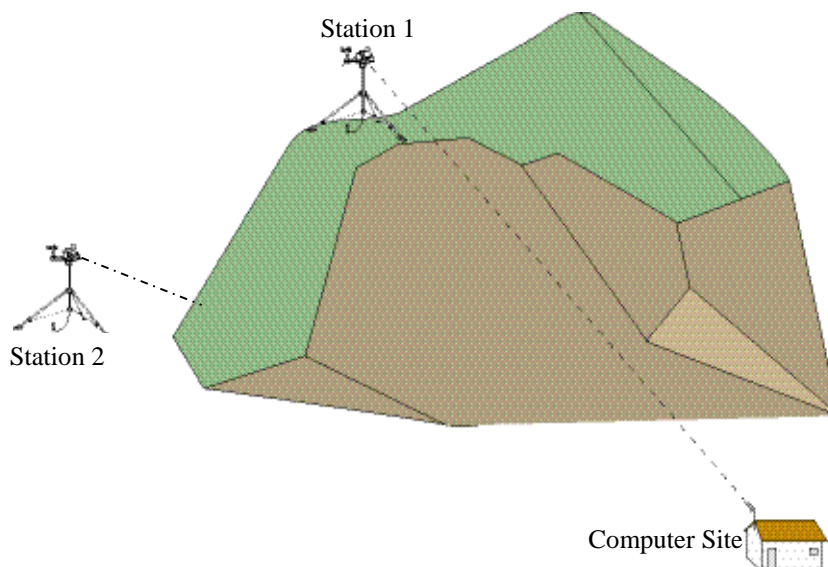


FIGURE 5-2. Line-of-sight example

5.3.2.3 Testing Radio Transmissions

To test the radio transmission of your weather station, carry the weather station to the site attached to the tripod or mounting pole then attempt to communicate with the weather station using the host computer. See Section 4, *QuickStart Guide* (p. 2), for instructions. When testing the radio, disconnect the charging cable before turning the key switch to the off position. This avoids battery damage.

If obstructions in the line of sight are preventing the weather station from communicating, try the following:

1. Relocate your weather station away from obstructions.
2. Remove the obstructions.
3. Mount the computer base station antenna outside of the building by running the antenna cable through a window or cable run.
4. Use a higher gain antenna (optional) at the computer site.
5. Install a higher gain antenna (optional) on the roof of the computer site's building and align it above the obstructions.

NOTE

If you are still experiencing problems communicating, you can contact your distributor. To allow us to effectively help you, please be prepared to describe, in detail, your installation and site conditions.

5.3.2.4 Appropriate Update Interval Settings for Wireless Systems

Externally powered systems that do not use solar panels for battery recharge have no update limitations.

When using a solar panel, the update interval should be set to 10 s or greater because of power budget limitations. TurfWeather weather station wireless systems located above 40 degrees North/South Latitude should have an update interval of 60 s, or greater, during periods of limited solar incidence.

Monitor battery voltage to determine power drain in your application, and do not allow the battery voltage to drop below 12 Vdc. Adjust the update interval as needed to prevent battery discharge and communication failure.

5.4 Installation Procedures

Many installation configurations for the weather station are possible. This document describes standard installation configurations. For questions about installation configurations not described in this document, contact your local distributor.

5.4.1 Assemble the 16776 Tripod

1. Attach tripod feet to the legs of the 16776 tripod using the bolts and self-locking nuts provided (see FIGURE 5-3).

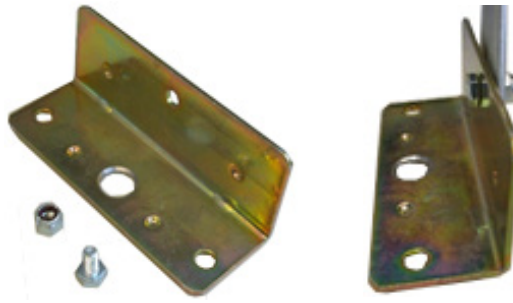


FIGURE 5-3. The 16776 Tripod/Mast Assembly includes the nut and bolt (left) used to attach each foot to the tripod

2. If using mast extension(s), pound the extension(s) into the mast by inserting the tapered end of the extension into the top of the mast and striking the extension top with a wooden block or hard rubber mallet (FIGURE 5-4).

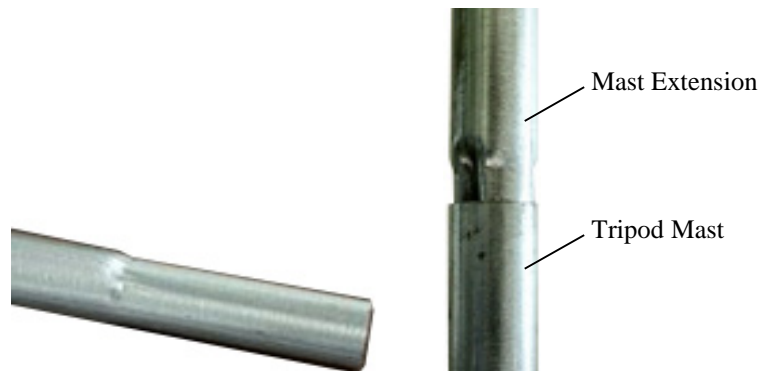


FIGURE 5-4. Mast extension (left) and mast extension inserted into the tripod mast

CAUTION

Do not use a metal hammer to pound in the mast extension since this will deform the top of the mast extension.

3. If using the guy-wire kit, loosely install the guy-wire kit (Section 5.4.3, *16772 Guy-Wire Kit Installation (p. 17)*).

NOTE

Do not tighten the turnbuckles yet. The turnbuckles will be tightened in step 5 of Section 5.4.4, *Mounting the TurfWeather Station on a Tripod or Pole (p. 18)*.

4. Install the mast in the tripod and adjust mast height if necessary (FIGURE 5-5). The mast height is adjusted by moving the tripod legs or removing the mast cup and sliding the mast up or down in the collars.

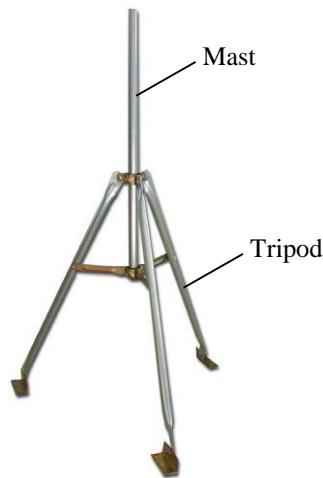


FIGURE 5-5. The mast fits in the center of the tripod

5. Once the mast height has been set, tighten all six collar bolts.
6. Install the tripod at the site (see Section 5.4.2, *Ground Installations (p. 16)*).

5.4.2 Ground Installations

1. If needed, prepare the site. A temporary site may require brush or tall weeds to be removed and footings dug if the site is not level. A permanent site may require pouring a concrete pad or fabricating some other form of a permanent base.
2. Use a rubber band to attach a level device, such as the one in the 16770 Tripod Installation Kit, to the midpoint of the tripod mast.
3. Place the tripod on the site.
4. Adjust tripod footings until the mast is level. Some adjustment is available by loosening/tightening the upper and lower collar bolts. If more adjustment is required, then for temporary sites, remove or replace soil under the feet. For permanent installations, use shims to adjust the foot foundation height.

NOTE

For temporary sites, ensure the soil under the tripod feet is well compacted. Otherwise, the tripod may not remain level after the tripod feet have been secured to the ground.

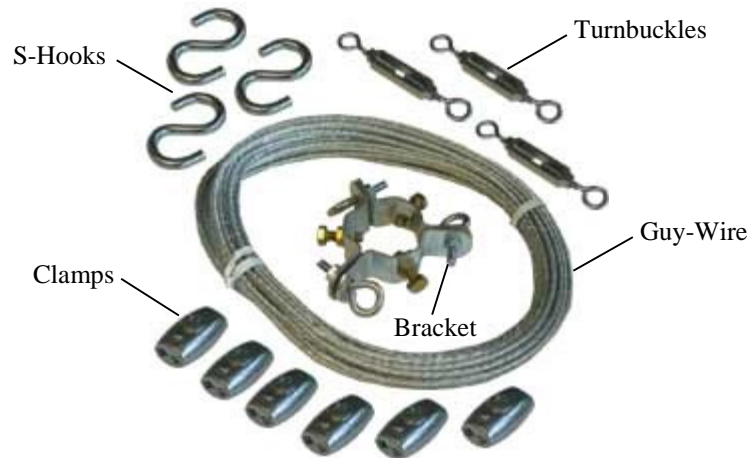
- Secure the tripod feet to the ground. For temporary sites, the stakes included in the 16773 Tripod Stake Kit are driven through the center hole in each tripod foot (FIGURE 5-6). The stakes should be driven in until they barely contact the foot surface. For permanent sites, user-supplied bolts are driven through the holes in each tripod foot.



FIGURE 5-6. Temporary sites use stakes included in the 16773 Tripod Stake Kit (left) driven through the center hole in each tripod foot (right)

- Follow the procedure in Section 5.4.4, *Mounting the TurfWeather Station on a Tripod or Pole* (p. 18).

5.4.3 16772 Guy-Wire Kit Installation



- Cut the guy-wire cable into three equal length pieces.
- Loop one end of each guy-wire through a bracket eye bolt and clamp the guy-wire using one of the clamps provided.
- Install the bracket on the tripod mast about 15 cm (6 in) from the top of the mast then loosely tighten the bracket bolts that lock it to the mast.

4. Insert the mast into the tripod and rotate the mast assembly until the bracket eye bolts all line up with a tripod leg then loosely tighten the mast collar bolts on the tripod.
5. Tighten the guy-wire bracket bolts until they deform the mast by dimpling the surface to assure the bracket does not slide when the turnbuckles are tightened.
6. Unscrew the turnbuckle until approximately 80% of both eye bolt threads extend beyond the turnbuckle body.
7. Hook an S-hook to an eyelet on each of the tripod feet. Alternatively, the S-hooks can be connected to user-supplied eye bolts set into a concrete pad or another fixed structure.
8. One at a time, grasp a guy-wire and loop it around its corresponding S-hook to roughly determine its correct length then cut the guy-wires to eliminate any excess length.
9. Hook the unattached end of each S-hook to an eye bolt on the end of a turnbuckle.
10. Loop the free end of each guy-wire through its respective turnbuckle eye bolt and pull it tightly then clamp the guy-wire using one of the clamps provided.

NOTE

- a. The guy-wires need to remain loose until after the weather station assembly has been properly oriented. The turnbuckles are tightened in step 5 of Section 5.4.4, *Mounting the TurfWeather Station on a Tripod or Pole* (p. 18).
 - b. Guy-wires will stretch for a few weeks after installation. Therefore, periodically check them for tension and retighten the turnbuckles as required until they stop stretching.
-

5.4.4 Mounting the TurfWeather Station on a Tripod or Pole

NOTE

This procedure assumes the weather station has been set up and tested at the computer location (see Section 4, *QuickStart Guide* (p. 2)), and that a tripod or pole has been installed at the site.

1. Place your weather station assembly on top of the mast or pole with the base firmly seated on the top edge of the mast or pole (FIGURE 5-7).

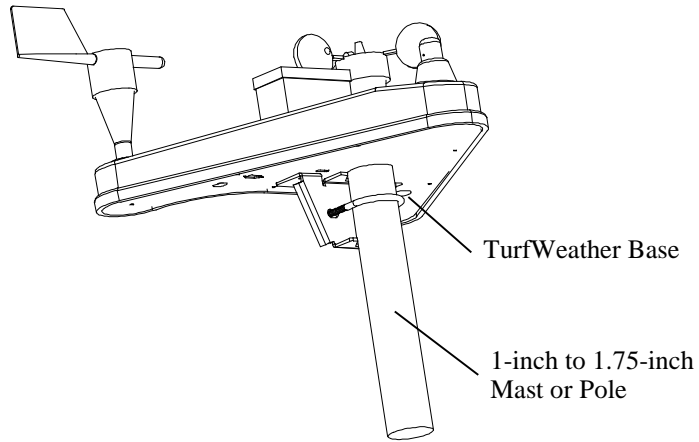


FIGURE 5-7. The TurfWeather weather station assembly properly seated on a mast or pole

NOTE

To mount on a larger pole with a diameter up to 2.125 inches, a 5/16 x 2-1/8 inch stainless steel U-bolt (pn 17492) can be used.

2. Loosely tighten the U-bolt nuts so that the weather station is stable but can be rotated on the mast or pole (FIGURE 5-8).

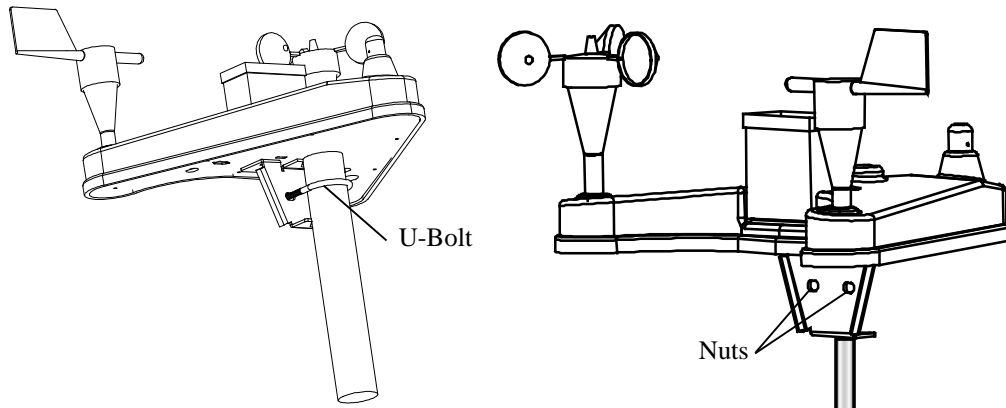


FIGURE 5-8. Two views of the TurfWeather station. The U-bolt and nuts are shown.

3. As a reference, use a magnetic compass (supplied in the optional Tripod Installation Kit) and rotate the weather station assembly until the reference line on the wind direction sensor is aligned with Magnetic North (FIGURE 5-9).

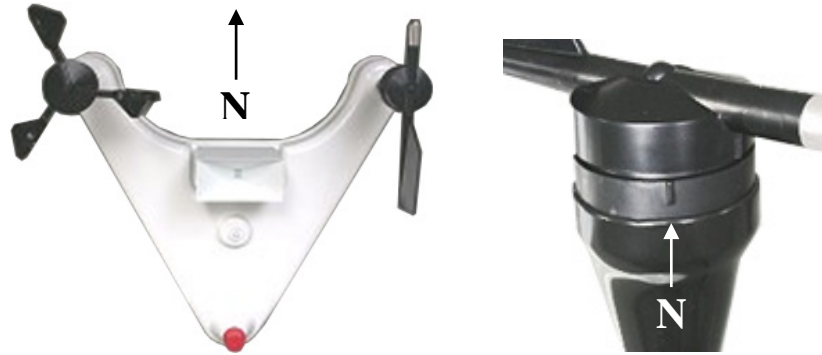


FIGURE 5-9. Accurate wind direction measurements require the reference line on the wind direction sensor (right) to be aligned with Magnetic North

4. Firmly tighten the U-bolt nuts.
5. If the guy-wire kit has been installed, assure that its orientation will not interfere with the solar panel (if one is installed) then evenly tighten the turnbuckles to tension the guy-wires.
6. Confirm the weather station is level by viewing the bubble level on top of the weather station (FIGURE 5-10). Minor adjustments can be made by tightening or loosening the appropriate guy-wire turnbuckle, placing shims between the weather station base and the top of the mast or pole, or loosening the mast bolts at the top and bottom of the tripod and shifting the vertical orientation.

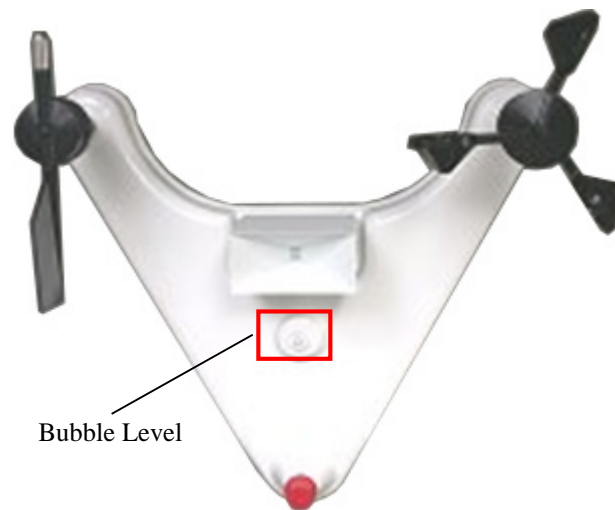


FIGURE 5-10. The bubble level (in red box) confirms the station is level, which is required for accurate rainfall and solar radiation measurements

7. Connect the power source that will recharge the internal sealed rechargeable battery. If using a solar panel, follow the steps provided in Section 5.4.5, *SP5 Solar Panel Installation* (p. 21). If using an external power supply, the external power supply needs to have an output of 18

Vdc and weatherproof connectors to be compatible (see Section 2, *Precautions* (p. 1)).

NOTE

-
- a. The internal sealed rechargeable battery must be recharged to assure continued system function.
 - b. 16876 AC Converter when used must be installed in a non-condensing environment or a weatherproof enclosure.
-
8. Remove the red or green cap from the solar radiation sensor (FIGURE 5-11). The cap protects the solar radiation sensor while the TurfWeather is being shipped and installed. Accurate measurements require the cap to be removed.

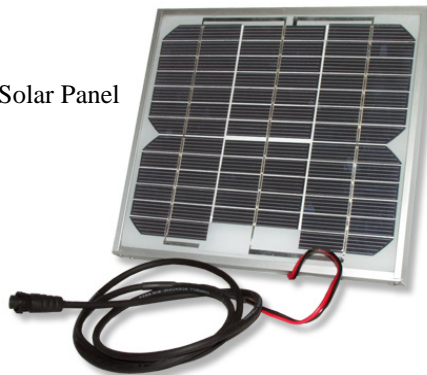


FIGURE 5-11. Remove the red or green cap

9. Properly ground the weather station (see Section 2, *Precautions* (p. 1)). The 16775 Ground Kit is available for ground located installations (see Section 5.4.6, *16775 Ground Kit Installation* (p. 22)).
10. Turn the weather station key to the on position and return to the computer site to confirm the weather station is working properly.

5.4.5 SP5 Solar Panel Installation

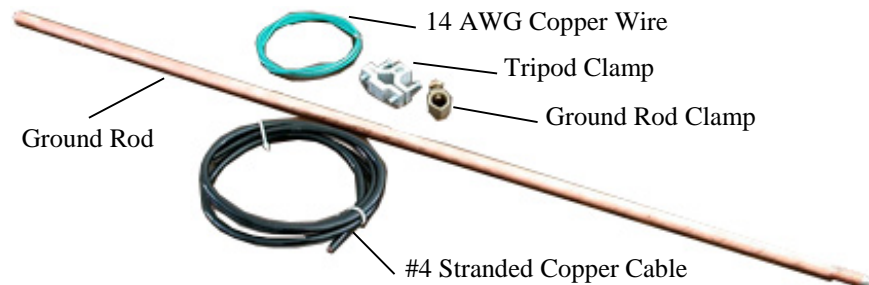
5 W Solar Panel



1. Place the solar panel on the mast below the station not to exceed the maximum distance allowed by the solar panel cable.
2. Loosely tighten the U-bolt so that the solar panel is stable but can be rotated on the mast or pole.
3. Use a compass (supplied in the optional Tripod Installation Kit) to properly align the solar panel. If your installation site is in Northern hemisphere locations, such as the United States and China, the glass surface of the panel should face South. If your installation site is in Southern hemisphere locations, such as Brazil and Australia, the glass surface of the panel should face North.
4. Connect the solar panel cable to the connector on the bottom of the weather station marked **Solar/DC Charger**.

5.4.6 16775 Ground Kit Installation

Before installing the ground kit, see Section 2, *Precautions (p. 1)*. The 16775 grounding kit is for ground installations only.



1. Connect the lug of the 14 AWG copper wire to the connector labeled **Ground Lug** on the bottom of the weather station (FIGURE 5-12).

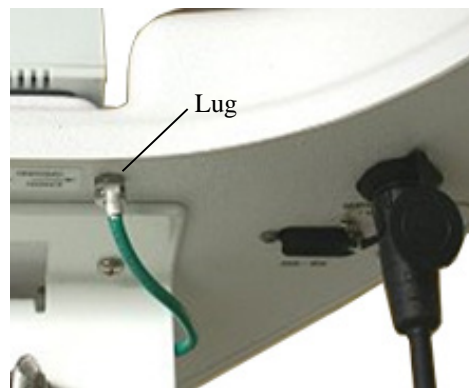


FIGURE 5-12. The ground lug connected to the bottom of the weather station

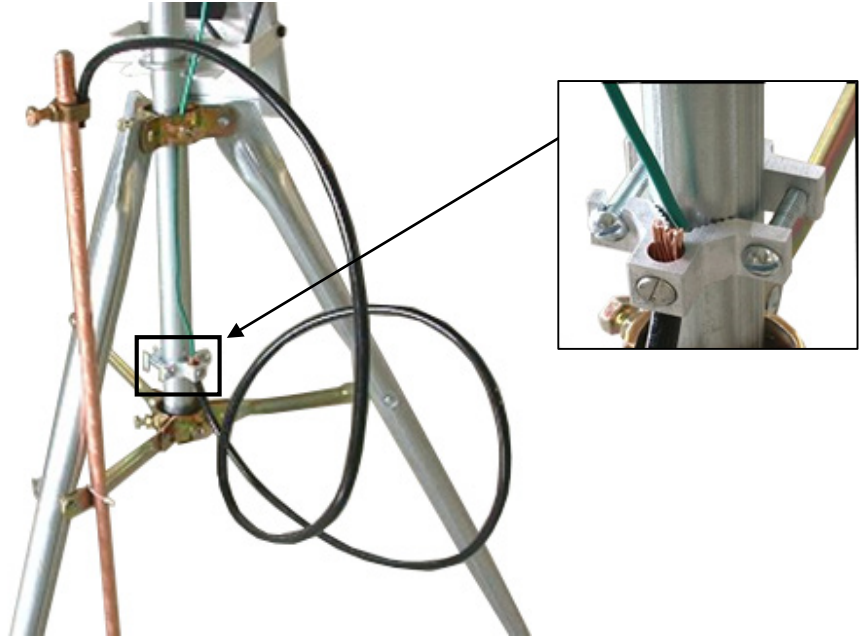


FIGURE 5-13. The right close up is the 14 AWG wire and the #4 cable attached to the tripod coupling

2. Mount the tripod coupling on the tripod mast so that it clamps the 14 AWG wire against the tripod (1 of FIGURE 5-13).
3. Drive the ground rod into the soil using a fence post driver or sledge hammer leaving about 7.5 cm (3 in) above the ground.
4. Loosen the middle screw in the tripod coupling.
5. Place one end of the #4 cable in the tripod coupling hole then tighten the screw (2 of FIGURE 5-13).
6. Attach the other end of the #4 cable to the ground rod using the ground rod coupling (FIGURE 5-14).



FIGURE 5-14. The #4 cable connected to the ground rod

5.4.7 Base Radio and Standard Antenna Installation

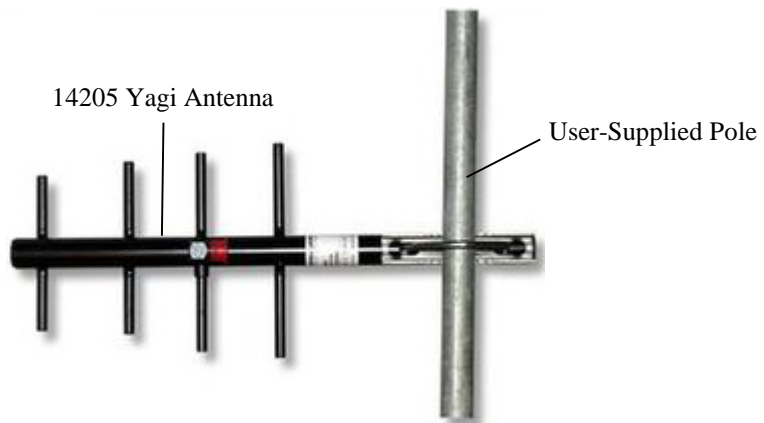


1. Install the 1/2 whip antenna onto the bottom of the weather station. This will thread onto the connector marked **ANTENNA**.
2. Attach to the RPSMA connector on the window mount antenna to the RF401-series base radio. Remove the strip covering the adhesive on the antenna and stick it vertically to a window (FIGURE 5-15).
3. Attach the serial cable from the calling computer's serial port to the **RS-232** port on the RF401-series base radio.
4. Plug the wall adapter into a wall outlet and plug the barrel connector into the **Power** connector on the RF401-series base radio. The radio's red **TX** LED should light up.



FIGURE 5-15. A typical RF401-series base station

5.4.8 High Gain Base Station Antenna Installation



The physical installation of a TurfWeather weather station high gain base station antenna system does not require training or special tools. However, it is very important to review the cautions and warnings provided in Section 2, *Precautions* (p. 1).

Tools required:

- 1/2-inch wrench
- 3/8-inch wrench
- #2 Phillips screwdriver

Customer supplied materials required:

- Antenna mounting pole – 1 1/4 to 2 inch O.D. metal pipe, or tripod assembly
- Pole/tripod mounting hardware
- Spade or ring lug connector (00 gage)

Antenna kit components required:

- High gain Yagi-directional antenna (900 MHz, pn 14205 or 2.4 GHz, pn 22072)
- Antenna mounting bracket
- COAXNTN-L50 or COAXNTN-L100 low loss antenna cable
- Polyphaser impulse suppressor module (900 MHz, IS-50NX-C2 pn 14462; or 2.4 GHz, LCU2.4 pn 16982)
- COAXRPSMA Polyphaser-to-RF401 cable (included with pn 14462 and pn 16982)
- Weather station grounding kit

pn 16775 Weather station grounding kit components:

- Copper clad grounding rod
- Heavy gage (00) ground cable
- Ground rod-to-cable clamp – brass
- Mast ground clamp (discard – not required for antenna installation)
- Weather station ground wire – green (discard – not required for antenna installation)

NOTE

The pn 16775 grounding kit contains basic components used for grounding either a tripod, or a buss bar. This kit may need to be supplemented by the user to meet the requirements of any specific site.

1. Location Preparation:

- a. Determine the best location for the antenna, assuming that the distance from the antenna to the radio base station is equal to, or less than, the length of the COAXNTN-L antenna cable.
- b. Assure that the ground rod is installed into the soil as close to the location of the Polyphaser as is possible.

NOTE

A ground wire (00 gage) is supplied but it may not be long enough for all installations. If a longer ground cable is required, purchase a continuous length to meet the site requirement but always use the minimum length necessary. Do not reduce the gage of this wire if a longer length is required. An alternate method of earth grounding may be employed but should be confirmed by a qualified RF technician before use.

- c. Mount the Polyphaser within 1.5 m (5 ft) of the location of the radio base station on a ground plane, or ground buss bar, inside a weatherproof enclosure or building. Mounting recommendations are supplied with the Polyphaser.

NOTE

The ground plane or buss bar will also be the connection point for the earth ground cable to the exterior ground rod, or interior earth ground connection.

- d. Connect the heavy gage (00 gage) ground wire to the ground plane or buss bar using a 00 bolted ring or spade lug connector (not supplied). Connect the other end of the heavy gage ground wire to the ground rod using the brass rod clamp supplied, or connect to the alternate interior earth ground point.
 - e. Verify connection to the earth ground from the case of the Polyphaser.
2. Component Installation:
- a. Mount the antenna in the proper orientation, with the connector at the bottom.
 - b. Connect one end of the antenna cable to the antenna and install the cable up to the location of the Polyphaser. Assure that a drip loop is maintained in the cable at the base of the antenna, and at the point where the cable will enter a weatherproof enclosure or building. The drip loops will minimize the amount of rainwater that will run down the cable to the enclosure or building.

NOTE

The minimum bend radius of the antenna cable is 15 cm (6 in). Tight bends in the antenna cable, or clamps that crush the cable, will damage the internal insulation and compromise the cable. Handle the antenna cable with care.

- c. Connect the antenna cable to the Polyphaser module connector marked **ANTENNA**.
- d. Connect one end of the short RPSMA Polyphaser-to-RF401 coaxial cable to the **EQUIPMENT** side of the Polyphaser module, and the other end to the antenna connector on the RF401-series radio.

3. Principle of Operation:
 - a. A Yagi high gain antenna is a directional RF device designed to minimize signal attenuation at the base station location, thereby providing the maximum available energy at the antenna for communication with the remotely located weather station. This antenna needs to be aimed and the best result is obtained with a clear line-of-sight to the remote transceiver. If you can see the weather station, the system has a clear line-of-sight.
 - b. The Polyphaser senses the presence of a high voltage electrostatic energy pulse and passes it to earth ground before it can damage the radio.
4. System Test:
 - a. Initiate the system software and verify that the radio will communicate with the weather station. See Section 4, *QuickStart Guide* (p. 2).

5.4.9 17342 Short-Haul Modem Installation



1. Attach the enclosure from 17342 kit onto the tripod or mounting pipe under the TurfWeather weather station using the supplied U-bolts. Mount this underneath or opposite of the solar panel if used to prevent shadowing on the solar panel (FIGURE 5-16).
2. Connect the 17326 cable to the connector on the bottom of the enclosure marked **WEATHER STATION**. Connect the other end of this cable to the bottom of the weather station marked **RS-232** and thread the thumb screws into the connector to secure the cable connector to weather station (FIGURE 5-17 and FIGURE 5-18).
3. Connect the 12002 cable to the connector on the bottom of the enclosure marked **COMPUTER**. The other end of this cable has a red wire labeled **+RCV**, a black wire labeled **-RCV**, a green wire labeled **+XMT**, and a white wire labeled **-XMT**. Connect these wires to the customer-supplied cable using the direct burial splice kits. The wire used from the user-supplied cable to connect to the red **+RCV** wire should be connected to the terminal marked **+RCV** on the short haul modem used on the computer end of cable run. The remaining wires should follow the same procedure so that each wire is connected to the corresponding terminal on the short haul modem.

4. On the computer end of the user-supplied cable, connect the wires as described above to the SRM-5A short haul modem. The connector marked **+RCV** should be connected to the wire in the user-supplied cable that connects to the red wire on the 12002 cable and so on.
5. Connect the 15751 9 to 25 pin adapter to the SRM-5A short haul modem.
6. Connect the serial cable to the 15751 adapter.
7. Connect the other end of the serial cable to the computer.

CAUTION

a. 18 AWG is recommended for the user-supplied cable, and must have at least 4 conductors plus shielding with a bare wire. This bare wire and any unused conductors should be connected to an earth ground on one end or the other to help prevent electrical noise from interfering with communication. Cable lengths exceeding 1/2 mile are not recommended due to additional splices, and increased probability of cable becoming damaged. Maximum of 2 miles.

b. The DCE/DTE switches on the SRM-5A short haul modems are set to DCE for the computer, and DTE at the weather station (inside enclosure). 9600 bps should be used with weather software and *PC200W* settings.



FIGURE 5-16. Short haul enclosure mounted to the 16776 tripod



FIGURE 5-17. Cables connected to enclosure for short haul modem



FIGURE 5-18. Short haul modem cables connected to TurfWeather station

5.4.10 Auxiliary Battery Unit Installation Procedure

The installation of a TurfWeather weather station auxiliary battery unit does not require training, special tools, or test equipment. However, the main body of the weather station does need to be opened, and the person performing this procedure should observe basic electrostatic discharge (ESD) precautions (described below) to avoid damage to the weather station electronics inside the main body of the weather station. There is no personal electrical hazard

involved, and this procedure can be accomplished by anyone possessing basic mechanical skills. Please read this entire procedure before beginning work.

Tools Required:

- 1/2-inch wrench
- 5/16-inch wrench
- #2 Phillips screwdriver
- Small wire cutter

pn 18914 Auxiliary Battery Unit kit components:

- Enclosure with 7 Ah battery
- 18971 Battery Cable
- U-bolt, washers and brass nuts



1. Remove the internal battery:
 - a. Follow step 1 in Section [6.9.2, Battery Pack Replacement Procedure](#) (p. 42).
 - b. Reinstall bracket and screws without battery.
2. Wiring modifications:
 - a. Locate the yellow wire marked **Batt +** and remove the protective tape.
 - b. Locate the terminal marked **Battery +** on the circuit board and open the connector lever. Install the yellow wire marked **Batt +** into this connector and close the lever (FIGURE [5-19](#)).

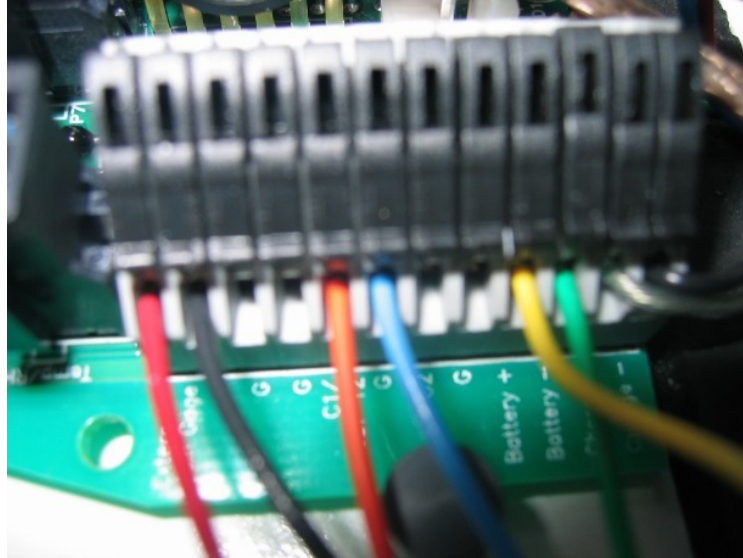


FIGURE 5-19. Yellow wire connected to Battery+ terminal

- c. Use new cable ties to secure the cable as it was before you clipped the original cable tie(s), or reuse the original ties if possible.
 - d. Place the two sections of the weather station main body together, making sure that none of the wiring bundles will be crushed by the edges, or by the seven housing screws when the sections are secured.
 - e. Reinstall and tighten the seven screws that hold the weather station main body sections together.
 - f. Reinstall the TurfWeather station on the mast or pole in original location and orientation. Reconnect the **SOLAR/CHARGER** cable.
3. Enclosure Installation:
- a. Place the enclosure underneath or opposite of the solar panel to prevent shadowing on the solar panel (FIGURE 5-20).
 - b. Attach the enclosure to TurfWeather weather station mounting pole using the U-bolt, flat washers, locking washers, and brass nuts supplied. Use the 1/2-inch wrench to tighten the two U-bolt nuts.
 - c. Attach the 2 pin connector on the 18971 cable to the bottom of the enclosure (FIGURE 5-21).
 - d. Attach the 6 pin connector on the 18971 cable to the bottom of the TurfWeather weather station's **AUXILIARY** connector (FIGURE 5-22).



FIGURE 5-20. Auxiliary battery enclosure mounted to the 16776 tripod



FIGURE 5-21. 18971 cable connected to auxiliary battery enclosure



FIGURE 5-22. 18971 cable connected to TurfWeather station

5.4.11 ATP100 Auxiliary Telemetry and Power Unit Installation Procedure

The installation of a TurfWeather weather station auxiliary telemetry and power unit does not require training, special tools, or test equipment. However, the main body of the weather station may need to be opened, and the person performing this procedure should observe basic electrostatic discharge (ESD) precautions (described below) to avoid damage to the weather station electronics inside the main body of the weather station. There is no personal electrical hazard involved, and this procedure can be accomplished by anyone possessing basic mechanical skills. Please read this entire procedure before beginning work.

There are several communication options for the ATP100. This section will cover basic equipment installation.

For more detailed instructions on the specific communication option ordered, please refer to the corresponding manual for that product. For example, the ATP100 –WIFI option includes the NL240 Wireless Network Link Interface. Refer to the NL240 manual, <https://s.campbellsci.com/documents/us/manuals/nl240.pdf>, for any additional details needed for this device.

The –WIFI with –AH Ad Hoc sub option includes a second NL240 for a computer. Both NL240s are configured to work properly; no setting adjustments should be needed. For this configuration, a null cable is used between the computer COM port and the RS-232 port on the NL240. A wall transformer powers it.



FIGURE 5-23. ATP100 enclosure and TurfWeather station mounted to pole

Tools Required:

- 1/2-inch wrench
- 7/16-inch wrench
- 5/16-inch wrench
- #2 Phillips screwdriver
- Small wire cutter

pn 31840 ATP100 Auxiliary Telemetry and Power Unit kit components:

- 10 x 12 enclosure with 7 Ah battery and hardware for communication option selected
- 18971 Battery Cable
- 31654 RS-232 Cable
- U-bolts, washers, and brass nuts



NOTE

TurfWeather stations ordered as the -NB model, No Battery option, will not need to be opened to remove the internal battery and to make the wire connection as described below. This has already be done at the factory.

1. Remove the internal battery:
 - a. Follow step 1 in Section [6.9.2, Battery Pack Replacement Procedure](#) (p. 42).
 - b. Reinstall bracket and screws without battery.

NOTE

Touching a screw will ground any electrostatic energy difference between you and the main electronics board. Do not be concerned, as this will not shock you or create a spark.

2. Wiring modifications:
 - a. Locate the yellow wire marked **Batt +** and remove the protective tape.
 - b. Locate the terminal marked **Battery +** on the circuit board and open the connector lever. Install the yellow wire marked **Batt +** into this connector and close the lever (FIGURE 5-24).

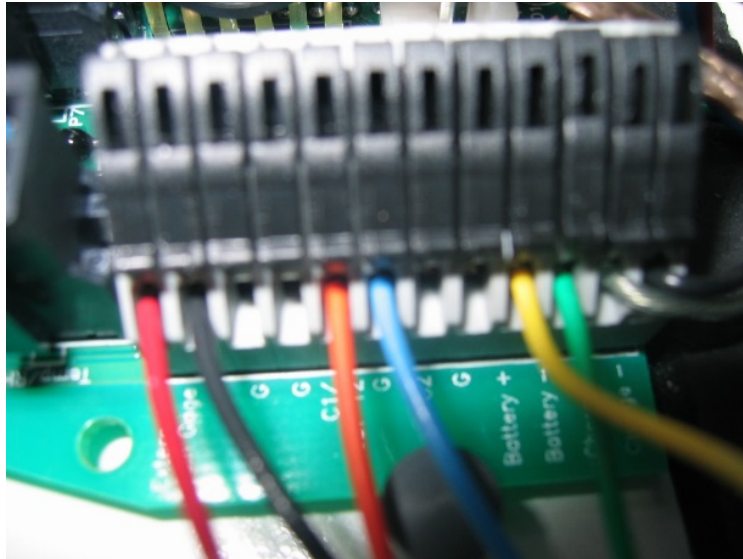


FIGURE 5-24. Yellow wire connected to Battery+ terminal

- c. Use new cable ties to secure the cable as it was before you clipped the original cable tie(s), or reuse the original ties if possible.
- d. Place the two sections of the weather station main body together, making sure that none of the wiring bundles will be crushed by the edges, or by the seven housing screws when the sections are secured.
- e. Reinstall and tighten the seven screws that hold the weather station main body sections together.
- f. Reinstall the TurfWeather station on the mast or pole in original location and orientation. Reconnect the **SOLAR/CHARGER** cable.

3. Enclosure Installation:

- a. Place the enclosure underneath or opposite of the solar panel to prevent shadowing on the solar panel (FIGURE 5-25).



FIGURE 5-25. Auxiliary battery enclosure mounted to the 16776 tripod

- b. Attach the enclosure to TurfWeather weather station mounting pole using the U-bolt, flat washers, locking washers, and brass nuts supplied. Use the 1/2-inch wrench to tighten the two U-bolt nuts. There is a second pair of U-bolts included to allow attaching to a wide range of pole diameters.
- c. Attach the 2 pin connector on the 18971 cable to the bottom of the ATP100 enclosure (FIGURE 5-26).
- d. Attach the 6 pin connector on the 18971 cable to the bottom of the TurfWeather weather station's **AUXILIARY** connector (FIGURE 5-27).
- e. Attach the 31654 RS-232 Cable between the 9 pin connector on the ATP100 enclosure to the bottom of the TurfWeather weather station's **RS-232** connector (FIGURE 5-26 and FIGURE 5-27).
- f. Install 7.0 amp hour battery into battery bracket and secure with Velcro strap. Connect red battery wire to red battery post, and black battery wire to black battery post (FIGURE 5-28).



FIGURE 5-26. 18971 cable and 31654 RS-232 cable connected to ATP100 enclosure



FIGURE 5-27. 18971 cable and 31654 RS-232 cable connected to TurfWeather station

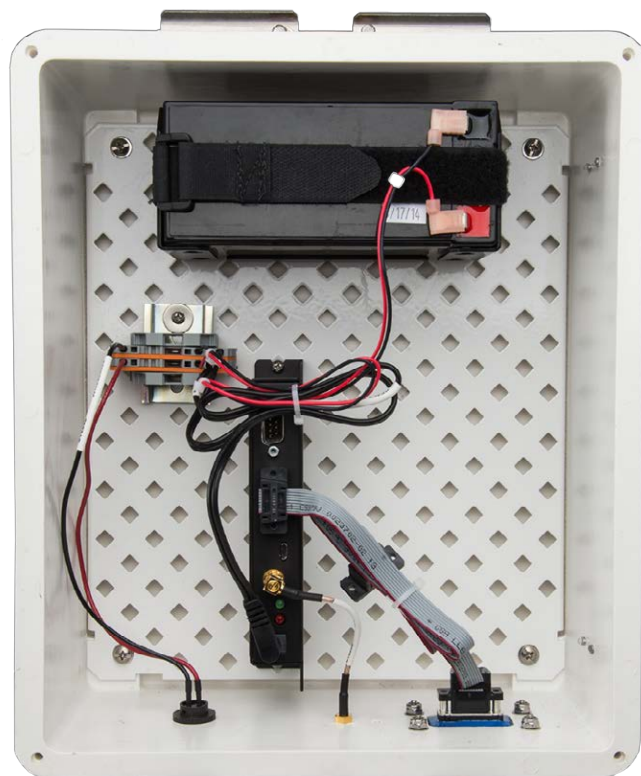


FIGURE 5-28. 7.0 Amp Hour Battery properly installed

6. Maintenance

Proper maintenance of the TurfWeather weather station is essential to obtain accurate data. Equipment must be in good operating condition, which requires a program of regular inspection and maintenance. Routine and simple maintenance can be accomplished by the person in charge of the weather station. Inspect the weather station weekly when first installed to get an understanding of how often cleaning and inspecting should be performed.

Keep the weather station level for accurate solar radiation and rain measurements. Use the level bubble located on top of weather station for reference.

More difficult maintenance such as sensor replacement can be accomplished with instructions included in this manual, or the TurfWeather station can be sent to Campbell Scientific if preferred.

6.1 Solar Panel pn SP5

An occasional cleaning of the glass on the solar panel will improve its efficiency. Use warm mildly soapy water and a clean cloth. Rinse with clean water.

6.2 Battery Pack pn 14159

The battery pack is a 12 Vdc, 0.8 Ah battery with a special connector. It has a life expectancy of three to five years. It is located inside the weather station. It

is a sealed lead acid battery design, and if it is discharged below 11.0 volts, it may become damaged and no longer accept a charge regardless of the age of the battery. *PC200W* and most weather software will display the weather station battery voltage. Typical measurements should be between 12.5 and 13.5 Vdc. See Section 6.9.2, *Battery Pack Replacement Procedure (p. 42)*, for instructions on replacement.

6.3 Temperature/Relative Humidity Sensor pn 14144

The temperature/relative humidity sensor has a life expectancy of 18 months. The relative humidity measurement will begin to drop off as the sensor ages. It is located on the bottom of the weather station inside the slotted cylinder-shaped protector. Take care not to expose this sensor to overspray from pesticides, fertilizers, etc. Use a soft brush to remove dust and cob webs from sensor area. See Section 6.9.3, *Temperature/Relative Humidity Sensor Assembly Replacement Procedure (p. 45)*, for instructions on replacement.

6.4 Solar Radiation Sensor pn 14009

The solar radiation sensor has a life expectancy of approximately five years, at an expected 2% per year degradation rate. This sensor is replaced rather than recalibrated. It is the small round sensor located on the opposite end from the wind sensors. Keep this sensor clean using a soft cloth and very mild soapy water, and follow up with a clean damp cloth with water only. See Section 6.9.4, *Solar Radiation Sensor Replacement Procedure (p. 47)*, for instructions on replacement.

6.5 Rain Gage pn 25585

The rain gage has a life expectancy of five years or more. It is the box-shaped sensor on top of the weather station. Keep the funnel area clean from debris such as leaves and pine needles. Keep the tipping mechanism spoon clean by removing accumulated dirt build up. The spoon can be accessed by removing the top funnel from the main body of the rain gage. Hold the body with one hand while removing the funnel. The body, base, and funnel all just press together with no fasteners holding them. One tip of the spoon measures 1 mm (0.03937008 in) of rain. See Section 6.9.5, *Rain Gage Replacement Procedure (p. 50)*, for instructions on replacement.

6.6 Wind Speed Sensor pn 14010

The wind speed sensor has a life expectancy of five years or more. It is the black sensor with three cups that rotate as the wind blows. To check the wear of this sensor, gently rotate the sensor using your thumb and forefinger on the top point of the sensor. The sensor should move freely and feel very smooth. See Section 6.9.6, *Wind Speed Sensor (Anemometer) Replacement Procedure (p. 52)*, for instructions on replacement.

6.7 Wind Direction Sensor pn 14011

The wind direction sensor has a life expectancy of five years or more. It is the black sensor with a tail on one end and a stainless steel nose on the other end. To check the sensor for wear, gently rotate the sensor's top half. The sensor should move freely and feel very smooth. See Section 6.9.7, *Wind Direction Sensor Replacement Procedure (p. 54)*, for instructions on replacement.

6.8 Memory Battery pn 15598

The memory battery is a small coin cell type battery that will keep the clock time correct and the stored data when the power supply and battery pack are not supplying power to station. Life expectancy is five years or more. This battery voltage should be above 3 Vdc, and can be displayed using *PC200W* software. The battery manufacturer's model number is the CR1016. See Section 6.9.8, *Memory Battery Replacement Procedure (p. 56)*, for instructions on replacement.

6.9 Equipment Removal and Replacement

The following sections provide the procedures for removing and replacing TurfWeather sensors, batteries, and radio. These procedures do not require training, special tools, or test equipment. There is no personal electrical hazard involved, and these procedures can be accomplished by anyone possessing basic mechanical skills. For each of these procedures, read through the entire procedure before beginning work.

6.9.1 Removing the TurfWeather Station from the Mast or Pole

Tools Required:

- 1/2-inch wrench
 - 5/16-inch wrench
1. Turn the power switch on the weather station to the **OFF** position.
 2. Disconnect your solar panel or dc power supply input cable from the weather station.
 3. Disconnect the ground wire connections from the weather station, using the 5/16-inch wrench.
 4. Remove the weather station from its location by using the 1/2-inch wrench to loosen the two U-bolt nuts that secure the weather station to its mast.

NOTE

Do not remove the mast bracket from the weather station.

5. Make note of the orientation of weather station.

6.9.2 Battery Pack Replacement Procedure

This removal and replacement procedure for the internal battery pack (pn 14159) requires the main body of the weather station to be opened. The person replacing this sensor should observe basic electrostatic discharge (ESD) precautions (described below) to avoid damage to the weather station electronics inside the main body of the weather station.

Tools Required:

- 1/2-inch wrench
- 5/16-inch wrench
- #2 Phillips screwdriver
- Small wire cutter

1. Battery Pack Removal:

- a. Follow steps provided in Section 6.9.1, *Removing the TurfWeather Station from the Mast or Pole* (p. 42).
- b. Bring the weather station to an enclosed location, preferably near the host computer, and place it on a flat stable surface with an area of at least three times the size of the weather station base.
- c. Invert the weather station main body and rest it on a support that eliminates any stress on the wind speed or wind direction sensors and/or the rain gage. A rolled bath towel placed in the center of the main body, next to the rain gage, will generally suit the purpose.
- d. Remove the seven Phillips head screws on the base of the main body that hold the base section to the electronics enclosure section. Do not remove the Phillips head screws that connect the mast bracket to the weather station base. Notice that the three screws along the end with the wind sensors are shorter than the remaining four screws.
- e. Gently separate the electronics enclosure and base sections of the weather station main body, taking care not to place any stress on the wires that connect the two sections.
- f. Rest the base section next to the electronics section and locate the battery pack within the electronics section. It is a gray and black rectangular component at the front of the electronics section (FIGURE 6-1). It is retained by a white metal bracket that is held in place with two Phillips head screws. There is a cable, consisting of a red and a black wire, or a white and black wire that connects the battery pack to the main electronics board.

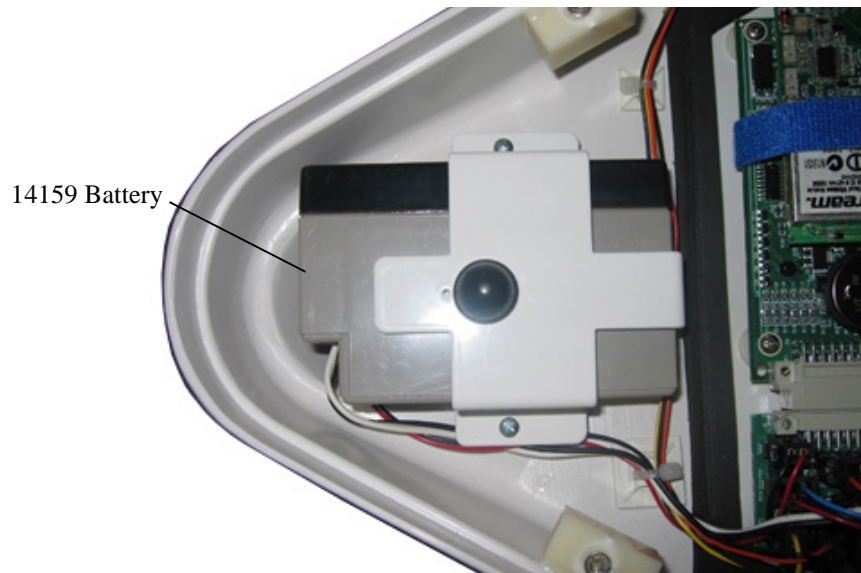


FIGURE 6-1. Inside of the TurfWeather

- g. Locate the other end of the battery cable connected to the main electronics board. It terminates in a white connector plugged into the main electronics board marked **BATTERY** (FIGURE 6-2). The wires are restrained along their length with either plastic cable ties, or with reusable cable restraints. Determine which type your weather station has and then release the wires by either cutting the cable ties with the small wire cutter, or by releasing the cable restraints.

NOTE Do not cut the wires to remove the battery pack.

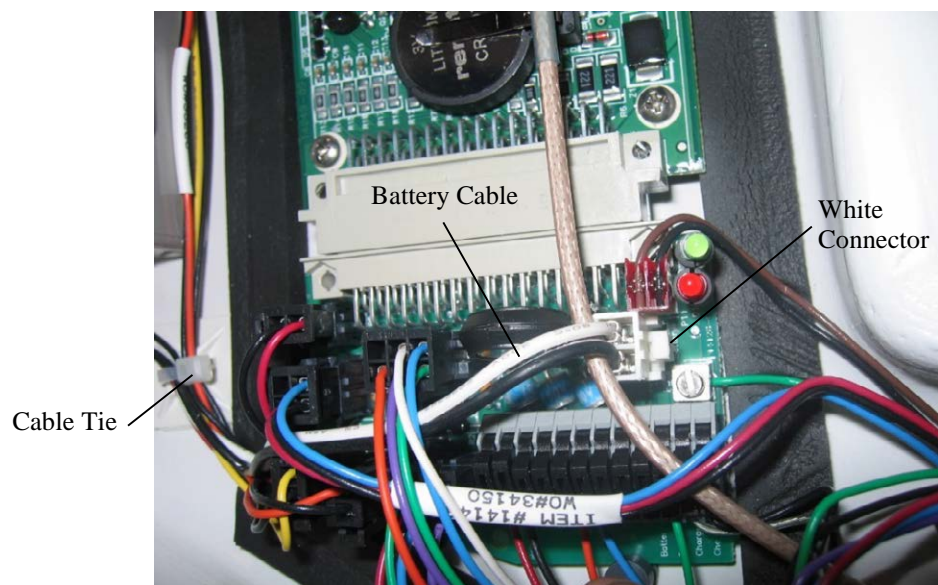


FIGURE 6-2. Main electronic board

- h. Disconnect the white battery pack cable connector from the main electronics board.

NOTE

Maintain ESD isolation by not touching any electronics boards or components on the boards inside the weather station.

- i. Use the Phillips screwdriver to remove the two screws holding the battery pack bracket into the electronics section, and remove the bracket.
 - j. Lift the battery pack from the weather station and properly dispose of the battery.
2. Battery Pack Replacement:
- a. Insert the new battery pack into the weather station where the previous battery pack was located.
 - b. Replace the battery pack retainer and tighten the Phillips head screws that hold it into the electronics section. Take care not to crimp the cable from the battery pack under the battery pack, or the retainer.
 - c. Carefully connect the white cable connector to the main electronics board, taking care not to touch the board or any components on electronics boards inside the weather station.
 - d. Align the battery pack cable in the cable restraints and again clamp them around the entire cable bundle. If your weather station uses cable ties, then use the ties supplied with the new battery pack and capture the cable as it was before you clipped the original cable tie(s).
 - e. Place the two sections of the weather station main body together, making sure that none of the wiring bundles will be crushed by the edges, or by the seven housing screws when the sections are secured.
 - f. Reinstall and tighten the seven screws that hold the weather station main body sections together.
3. System Test:
- a. Turn on the weather station power switch.
 - b. Look into the small window on the bottom of the weather station marked **Scan – Receive** and confirm that the LED flashes every 10 s.
 - c. Reinstall the weather station on its mast, and reconnect the ground and power wires.

6.9.3 Temperature/Relative Humidity Sensor Assembly Replacement Procedure

This removal and replacement procedure for the temperature/relative humidity (Temp/RH) sensor assembly (pn 14144) requires the main body of the weather station to be opened. The person replacing this sensor should observe basic

electrostatic discharge (ESD) precautions (described below) to avoid damage to the weather station electronics inside the main body of the weather station.

Tools Required:

- 1/2-inch wrench
- 5/16-inch wrench
- small wire cutter
- #2 Phillips screwdriver

Time Required: 15 to 30 minutes

1. Sensor Removal:

- a. Follow steps provided in Section 6.9.1, *Removing the TurfWeather Station from the Mast or Pole* (p. 42).
- b. Bring the weather station to an enclosed location, preferably near the host computer, and place it on a flat stable surface with an area of at least three times the size of the weather station base.
- c. Invert the weather station main body and rest it on a support that eliminates any stress on the wind speed or wind direction sensors and/or the rain gage. A rolled bath towel placed in the center of the main body, next to the rain gage, will generally suit the purpose.
- d. Remove the two Phillips head screws on the base of the main body that hold the mounting cover over the tube that covers the temperature/relative humidity sensor (FIGURE 6-3).
- e. Gently separate these components and pull out the temp/RH sensor until the connector is exposed.



FIGURE 6-3. Removing the temperature and RH sensor cover

2. Sensor Replacement:
 - a. Do not contaminate either of the sensor elements by exposing them to solvents.
 - b. Unplug the old sensor, and plug in the new sensor.
3. Reassemble the mounting cover and tube assemble with the new sensor onto the main body.
4. System Test:
 - a. Connect the weather station to the host computer using the short RS-232 test cable (if a wired system) and turn on the weather station power switch. Initiate communications with the weather station using *PC200W*.
 - b. Verify that the temperature and relative humidity sensors are reporting values. Gently blow air into the sensor protective screen on the bottom of the weather station and verify that both the temperature and relative humidity values increase. Stop blowing air on the sensors, and after a brief period the values should slowly decrease until the sensors return to equilibrium with the surrounding environment.
 - c. Reinstall the weather station on its mast, and then reconnect power and earth ground cables.

6.9.4 Solar Radiation Sensor Replacement Procedure

This removal and replacement procedure for the solar radiation sensor (pn 14009) requires the main body of the weather station to be opened. The person replacing this sensor should observe basic electrostatic discharge (ESD) precautions (described below) to avoid damage to the weather station electronics inside the main body of the weather station.

Tools Required:

- 1/2-inch wrench
- 5/16-inch wrench
- #2 Phillips screwdriver

1. Solar Radiation Sensor Removal:
 - a. Follow steps provided in Section [6.9.1](#), *Removing the TurfWeather Station from the Mast or Pole* (p. 42).



FIGURE 6-4. Solar radiation sensor

- b. Bring the weather station to an enclosed location, preferably near the host computer, and place it on a flat stable surface with an area of at least three times the size of the weather station base.
- c. Locate the solar radiation sensor on the front of the weather station. It is the gray plastic knob shaped protrusion on the top, front of the weather station (FIGURE 6-4). It is stamped on its side with the words **CSI APOGEE PYRC(number)**.
- d. Locate the Phillips head screw on the side of the sensor. Remove the screw but do not pull on or attempt to remove the sensor at this time.
- e. Invert the weather station main body and rest it on a support that eliminates any stress on the wind speed or wind direction sensors and/or the rain gage. A rolled bath towel placed in the center of the main body, next to the rain gage, will generally suit the purpose.
- f. Remove the seven Phillips head screws on the base of the main body that hold the base section to the electronics enclosure section. Do not remove the Phillips head screws that connect the mast bracket to the weather station base. Notice that the three screws along the end with the wind sensors are shorter than the remaining four screws.
- g. Gently separate the electronics enclosure and base sections of the weather station main body, taking care not to place any stress on the wires that connect the two sections.
- h. Rest the base section next to the electronics section and locate the battery pack within the electronics section. It is a gray and black rectangular component at the front of the electronics section (FIGURE 6-1). It is retained by a white metal bracket that is held in place with two Phillips head screws.
- i. Use the Phillips screwdriver to remove the two screws holding the battery pack bracket into the electronics section, and remove the bracket.

- j. Lift the battery pack from the electronics section and rest it next to the weather station.
- k. Locate the two wires that come from solar radiation sensor and follow them to their end connector on the weather station main electronics board. Cut or disconnect any cable ties along the length of the wires.
- l. Locate the screws on the corners of the main electronics board (largest green electronics board) and touch one finger to one of the screws on a corner of the board, then carefully disconnect the black solar radiation cable connector.

NOTE

Touching a screw will ground any electrostatic energy difference between you and the main electronics board. Do not be concerned, as this will not shock you or create a spark.

- m. Remove the solar radiation sensor by gently pulling it off its mounting post as you feed the wires through the hole in the top of the weather station module.
2. Solar Radiation Sensor Replacement:
- a. Insert the wire cable from the new solar radiation sensor into the weather station electronics module through the mounting post hole where the previous solar radiation sensor was located.
 - b. Again touch a finger to a screw on a corner of the main electronics board and then carefully reconnect the black solar radiation sensor connector.

NOTE

Touching a screw will ground any electrostatic energy difference between you and the main electronics board. Do not be concerned, as this will not shock you or create a spark.

- c. Align the solar radiation sensor cable in the cable restraints and again clamp them around the cable bundle. If your weather station uses cable ties, then use the ties supplied with the new solar radiation sensor and capture the cable as it was before you clipped the original cable tie(s).
- d. Replace the battery pack in its original location.
- e. Replace the battery pack retainer and tighten the Phillips head screws that hold it into the electronics section. Take care not to crimp the cable from the battery pack or the solar radiation sensor under the battery pack, or the retainer.
- f. Place the two sections of the weather station main body together, making sure that none of the wiring bundles will be crushed by the edges or by the seven housing screws when the two sections are secured with screws.
- g. Reinstall and tighten the seven screws that hold the weather station main body sections together.

- b. Bring the weather station to an enclosed location, preferably near the host computer, and place it on a flat stable surface with an area of at least three times the size of the weather station base.
 - c. Identify the rain gage as the white rectangular box located in the center, on top of the weather station (FIGURE 6-5).
 - d. Grasp the main body of the rain gage and gently pull it off of the weather station. This will expose two wires, leaving the rain gage base attached to the weather station.
 - e. Remove the wires from their connections inside the rain gage. The wires are screwed to a terminal strip, then loosen the screws and remove the wires.
2. Sensor Replacement:
- a. Connect the wires to the replacement rain gage. Tighten the terminal screws. It does not matter which wire is attached to which pin, this connection is not polarity sensitive.
 - b. Notice that the rain gage wires pass through a small indented location on one side of the rain gage base. When you replace the rain gage back onto its base, make sure that the wires are within the indent to assure they will not be crushed or crimped by the rain gage.
 - c. Place the rain gage on its base and gently press it down until it is firmly seated.
3. System Test:
- a. Connect the weather station to the host computer using the short RS-232 test cable (if a wired system) and turn on the weather station power switch; or initiate communications if your weather station is wireless.
 - b. Gently remove the top portion (catch basin) of the rain gage and identify the black spoon-shaped tipping bucket inside the rain gage.
 - c. Using your index finger, gently press the spoon down until you hear a faint click. This is the tip counting switch responding to the tiny magnet on the side of the spoon-shaped tipping bucket. Repeat this action several times and look for a change in the rain values reported by the *PC200W* or *T.Weather*. Each click is equal to 1 mm (0.04 in) of rain.

NOTE

Every rain gage is factory calibrated before it is shipped. If you want to validate calibration, please refer to the calibration instructions for the rain gage and complete the calibration before you reinstall the weather station on its mast.

- d. Replace the catch basin on the rain gage and reinstall the weather station on its mast.

6.9.6 Wind Speed Sensor (Anemometer) Replacement Procedure

This is the removal and replacement procedure for the wind speed sensor (pn 14010).

Tools Required:

- 1/2-inch wrench
- 5/16-inch wrench
- 1/4-inch wrench
- #2 Phillips screwdriver

1. Sensor Removal:

- a. Follow steps provided in Section 6.9.1, *Removing the TurfWeather Station from the Mast or Pole (p. 42)*.
- b. Bring the weather station to an enclosed location, preferably near the host computer, and place it on a flat stable surface with an area of at least three times the size of the weather station base.



FIGURE 6-6. Wind speed sensor with boot down and exposing wires

- c. Identify the wind speed sensor as the sensor with three cups that rotate around the main sensor body. It is located on the top, rear of the weather station main body.

CAUTION

Do not twist or place side pressure on either the wind speed or wind direction sensors at any time during this sensor removal/replacement process as it may cause them to break off of the weather station main body.

- d. Just below the sensor rotating cups, there is a flexible boot. Without using tools, peel the boot down, folding it back upon itself and the sensor mounting post. This will expose two wires connected to two separate threaded terminal studs, retained by 1/4-inch nuts (FIGURE 6-6).

NOTE

Take care not to place side pressure on the sensor itself, and do not place downward pressure on the weather station main body as this may damage the temp/RH sensor cage on the underside of the weather station.

- e. Using the 1/4-inch wrench, loosen the nuts and remove the wires.
- f. Locate the single Phillips head screw on the side of the sensor body.

NOTE

This is not either of the screws next to the threaded terminal studs. Using the Phillips screwdriver, remove the screw.

- g. Remove the sensor from its post by gently twisting and pulling it away from the post.

2. Sensor Replacement:

- a. Press the new wind speed sensor on the post until it is seated on the top of the mounting post.

NOTE

Orientation of this sensor is not important but it must be firmly seated on its mounting post.

- b. Install and tighten the Phillips head screw on the side of the sensor body one half turn beyond when it is initially tight in the hole (after it has bottomed against the sensor post). Gently pull on the sensor body to assure it is firmly attached to the sensor post. If not, then tighten the screw until the sensor cannot be removed.
- c. Reattach the two wires to the correct threaded terminal studs and tighten the nuts using the 1/4-inch wrench.

NOTE

It does not matter which wire is connected to which terminal stud. These connections are interchangeable.

- d. Unroll the rubber protective boot and assure that it completely covers the lower portion of the wind speed sensor, just as it did when you started this process.

3. System Test:

- a. Connect the weather station to the host computer using the RS-232 test cable (if a wired system) and turn the weather station power switch to the **ON** position. Initiate communications with your weather station using *PC200W*.

- b. Manually spin the sensor cups for a minute or two to verify that the wind speed sensor is reporting a value.
- c. Turn the weather station power switch to the **OFF** position.
- d. Reinstall the weather station on its mast; then reconnect power and ground wires before turning the weather station power switch to the **ON** position.

6.9.7 Wind Direction Sensor Replacement Procedure

This is the removal and replacement procedure for the wind direction sensor (pn 14011).

Tools Required:

- 1/2-inch wrench
- 5/16-inch wrench
- 1/4-inch wrench
- #2 Phillips screwdriver

1. Sensor Removal:
 - a. Follow steps provided in Section 6.9.1, *Removing the TurfWeather Station from the Mast or Pole* (p. 42).
 - b. Bring the weather station to an enclosed location, preferably near the host computer, and place it on a flat stable surface with an area of at least three times the size of the weather station base.



FIGURE 6-7. Wind direction sensor with boot down and exposing wires

- c. Identify the wind direction sensor as the black vane (arrow shaped) sensor located on the top, rear of the weather station main body.

CAUTION

Do not twist or place side pressure on either the wind speed or wind direction sensors at any time during this sensor removal/replacement process as it may cause them to break off of the weather station main body.

- d. Just below the sensor moveable vane, there is a flexible “boot” that will peel down from the top. Without using tools, peel the boot down, rolling the edge back upon itself and the sensor mounting post. Take care not to place side pressure on the sensor itself. This will expose three wires connected to three separate threaded terminal studs, held tight by 1/4-inch nuts (FIGURE 6-7).
- e. Using the 1/4-inch wrench, loosen the nuts and remove the wires, taking care to note which wires go on which threaded terminal studs.
- f. Locate the single Phillips head screw on the side of the sensor body. Using the Phillips screwdriver, remove the screw.

NOTE

These screws are not the screws next to the threaded terminal studs.

- g. Remove the sensor from its post by gently twisting and pulling it away from the post.

2. Sensor Replacement:

- a. Press the new wind direction sensor on the post until it is seated firmly on the top of the post.
- b. Gently twist the sensor body until the raised North reference is properly aligned.

NOTE

Refer to Section 4, *QuickStart Guide* (p. 2), for a picture of a properly aligned wind direction sensor.

- c. Install and tighten the Phillips head screw on the side of the sensor one half turn beyond when it is initially tight in the hole (after the screw has bottomed against the sensor post). Gently pull on the sensor body to assure it is firmly attached to the sensor post. If not, then tighten the screw until the sensor cannot be moved.
- d. Reattach the three wires to the correct threaded terminal studs and tighten the nuts using the 1/4-inch wrench. If you did not note the correct threaded terminal studs, look at the base of the sensor and count clockwise from the embossed **N** reference mark. The first stud will take the black wire, the second the blue wire and the third the red wire.

- e. Unfold the rubber protective boot and assure that it completely covers the lower portion of the wind direction sensor, just as it did before you started this process.
3. System Test:
 - a. Connect the weather station to the host computer using the RS-232 test cable (if a wired system) and turn on the weather station power switch. Initiate communications with your weather station using *PC200W*.
 - b. Verify that the wind direction sensor is reporting a position. The position number should be –0– when the tail of the sensor vane is aligned with the North reference. Confirm that the wind direction number increases when the vane is rotated clockwise.
 - c. Reinstall the weather station on its mast.

6.9.8 Memory Battery Replacement Procedure

This removal and replacement procedure for the memory battery (pn 15598) requires the main body of the weather station to be opened. The person replacing this sensor should observe basic electrostatic discharge (ESD) precautions (described below) to avoid damage to the weather station electronics inside the main body of the weather station.

Tools Required:

- 1/2-inch wrench
- 5/16-inch wrench
- #2 Phillips screwdriver
- Wooden toothpick or non-metallic tweezers

1. Memory Battery Removal:
 - a. Follow steps provided in Section 6.9.1, *Removing the TurfWeather Station from the Mast or Pole* (p. 42).
 - b. Bring the weather station to an enclosed location, preferably near the host computer, and place it on a flat stable surface with an area of at least three times the size of the weather station base.
 - c. Invert the weather station main body and rest it on a support that eliminates any stress on the wind speed or wind direction sensors and/or the rain gage. A rolled bath towel placed in the center of the main body, next to the rain gage, will generally suit the purpose.
 - d. Remove the seven Phillips head screws on the base of the main body that hold the base section to the electronics enclosure section. Do not remove the Phillips head screws that connect the mast bracket to the weather station base. Notice that the three screws along the end with the wind sensors are shorter than the remaining four screws.
 - e. Gently separate the electronics enclosure and base sections of the weather station main body, taking care not to place any stress on the wires that connect the two sections.

- f. Rest the base section next to the electronics section and locate the main electronics board within the electronics section. It is the largest green rectangular electronics board in the weather station electronics section. Locate the screws at the corners of the main electronics board and touch one of them with a finger to discharge any electrostatic difference between you and the electronics. Touching the screw(s) will not shock you or create a spark.

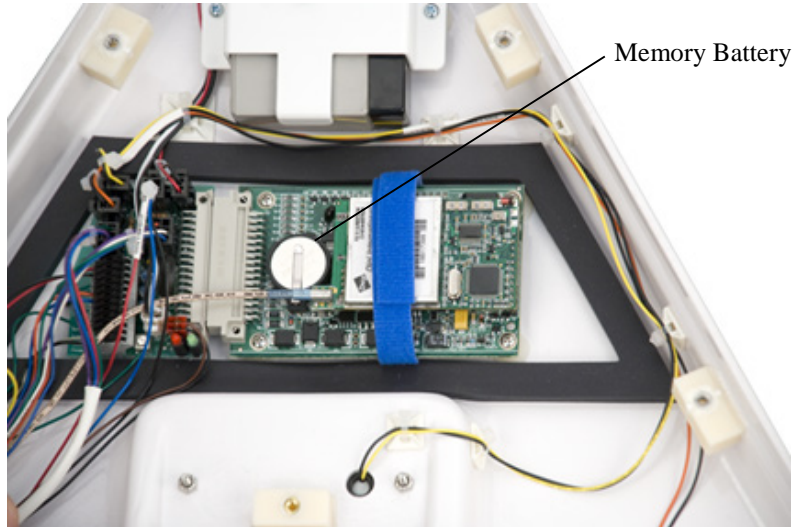


FIGURE 6-8. Memory battery inside TurfWeather station

- g. Locate the small disc-shaped memory battery (FIGURE 6-8) in the center of the main electronics board and, using a fingernail, gently lift the battery retaining clip; then use your wooden toothpick or non-metallic tweezers to extract the battery from the battery holder.
2. Memory Battery Replacement:
 - a. Determine which side of the new battery is the positive side. This will have a + stamped into the surface. This is the side that must be up (visible) when the battery is installed in the battery holder.
 - b. Lift the battery retaining clip slightly and slip the battery into the battery holder ensuring that it is correctly seated and tightly held in place by the battery retaining clip.
 - c. Place the two sections of the weather station main body together, making sure that none of the wiring bundles will be crushed by the edges or by the seven housing screws when the two sections are secured with screws.
 - d. Reinstall and tighten the seven screws that hold the weather station main body sections together.
 3. System test:
 - a. Turn on the weather station

- b. Look into the small window on the bottom of the weather station marked **Scan – Receive** and confirm that the LED flashes every ten seconds.
- c. Reinstall the weather station on its mast, and reconnect the ground and power wires.

6.9.9 Main Electronics Board (Motherboard) Replacement Procedure

This removal and replacement procedure for the main electronics board requires the main body of the weather station to be opened. The person replacing this sensor should observe basic electrostatic discharge (ESD) precautions (described below) to avoid damage to the weather station electronics inside the main body of the weather station.

Tools Required:

- 1/2-inch wrench
- 5/16-inch wrench
- #2 Phillips screwdriver

1. Main Electronics Board Removal:
 - a. Follow steps provided in Section 6.9.1, *Removing the TurfWeather Station from the Mast or Pole* (p. 42).
 - b. Bring the weather station to an enclosed location, preferably near the host computer, and place it on a flat stable surface with an area of at least three times the size of the weather station base.
 - c. Invert the weather station main body and rest it on a support that eliminates any stress on the wind speed or wind direction sensors and/or the rain gage. A rolled bath towel placed in the center of the main body, next to the rain gage, will generally suit the purpose.
 - d. Remove the seven Phillips head screws on the base of the main body that hold the base section to the electronics enclosure section. Do not remove the Phillips head screws that connect the mast bracket to the weather station base. Notice that the three screws along the end with the wind sensors are shorter than the remaining four screws.
 - e. Gently separate the electronics enclosure and base sections of the weather station main body, taking care not to place any stress on the wires that connect the two sections.

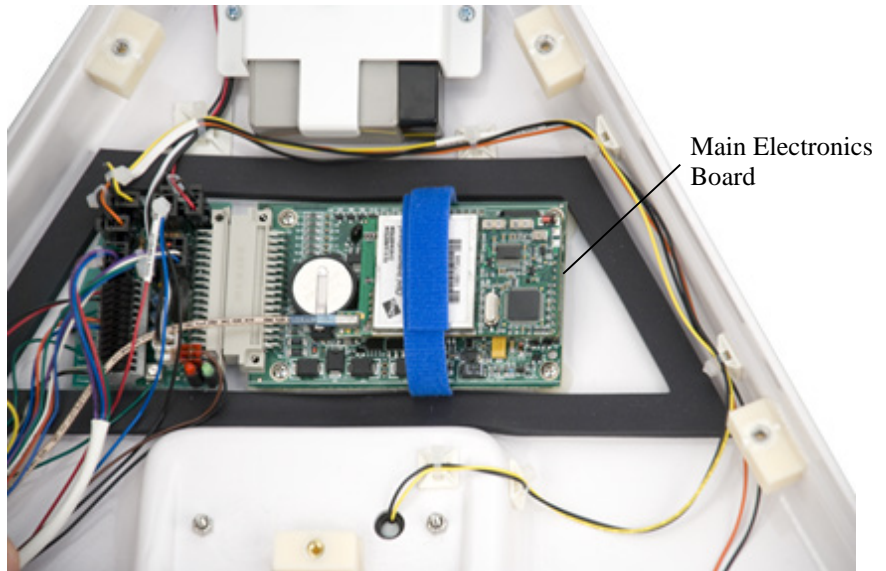


FIGURE 6-9. Main electronics board inside TurfWeather station

- f. Rest the base section next to the electronics section and locate the main electronics board within the electronics section (FIGURE 6-9). It is the largest green rectangular electronics board in the weather station electronics section.
 - g. Locate the screws at the corners of the main electronics board and touch one finger to one of the screws. Touching the screw will ground any electrostatic energy difference between you and the weather station main electronics board. Do not be concerned, as this will not shock you or create a spark.
 - h. Remove the four Phillips head screws that attach the main electronics board to the weather station electronics section.
 - i. Notice the gray plastic connector on one end of the main electronics board. This connects the board to the adjacent sensor connector board. Grasp both the main electronics board and the sensor connector board near the connector and gently pull them apart at the mating connector. You may need to use a slight side-to-side motion to separate the connector.
 - j. If you received a replacement main electronics board, it was shipped in a special ESD protective bag. Remove the replacement main electronics board from this bag and put the board you removed from your weather station into the same ESD bag.
2. Main Electronics Board Replacement:
- a. If your weather station is wireless, the replacement main electronics will have a spread spectrum radio board attached to it with a blue Velcro strap. The main carrier frequency for the radio board is printed on the white label with the word MaxStream. It will be either 900 MHz or 2.4 GHz. Verify that the carrier frequency is the same as that indicated on the spread spectrum radio you removed before

proceeding further. If it is not, and you are not intentionally changing the radio frequencies in both the weather station and the radio base station (they must be the same frequency), then contact your local distributor immediately.

- b. Orient the main electronics board so that the connector will mate with the connector on the sensor connector board. Press the two connectors together until they are firmly seated.
 - c. If your weather station is wireless, verify that the Velcro strap is tightly secured around the radio module.
 - d. Replace and tighten the four Phillips head screws that attach the main electronics board to the weather station electronics section.
 - e. Place the two sections of the weather station main body together, making sure that none of the wiring bundles will be crushed by the edges or by the seven housing screws when the two sections are secured with screws.
 - f. Reinstall and tighten the seven screws that hold the weather station main body sections together.
3. System test:
- a. Connect the weather station to the host computer using the short RS-232 test cable (if a wired system) and turn on the weather station power switch; or initiate communications if your weather station is wireless.
 - b. Verify that the sensors are reporting values.
 - c. Reinstall the weather station on its mast, and reconnect the ground and power wires.

6.9.10 Spread Spectrum Radio (all frequencies) Replacement Procedure

This removal and replacement procedure for the spread spectrum radio requires the main body of the weather station to be opened. The person replacing this sensor should observe basic electrostatic discharge (ESD) precautions (described below) to avoid damage to the weather station electronics inside the main body of the weather station.

Tools Required:

- 1/2-inch wrench
- 5/16-inch wrench
- #2 Phillips screwdriver

1. Spread Spectrum Radio Removal:
 - a. Follow steps provided in Section [6.9.1, Removing the TurfWeather Station from the Mast or Pole](#) (p. 42).

- b. Bring the weather station to an enclosed location, preferably near the host computer, and place it on a flat stable surface with an area of at least three times the size of the weather station base.
- c. Invert the weather station main body and rest it on a support that eliminates any stress on the wind speed or wind direction sensors and/or the rain gage. A rolled bath towel placed in the center of the main body, next to the rain gage, will generally suit the purpose.
- d. Remove the seven Phillips head screws on the base of the main body that hold the base section to the electronics enclosure section. Do not remove the Phillips head screws that connect the mast bracket to the weather station base. Notice that the three screws along the end with the wind sensors are shorter than the remaining four screws.
- e. Gently separate the electronics enclosure and base sections of the weather station main body, taking care not to place any stress on the wires that connect the two sections.
- k. Rest the base section next to the electronics section and locate the spread spectrum radio module within the electronics section. It is a green and white rectangular electronics board positioned on top of the weather station main electronics board. It has the word MaxStream on its top surface. It is retained on the main electronics board by a blue Velcro strap (FIGURE 6-10).

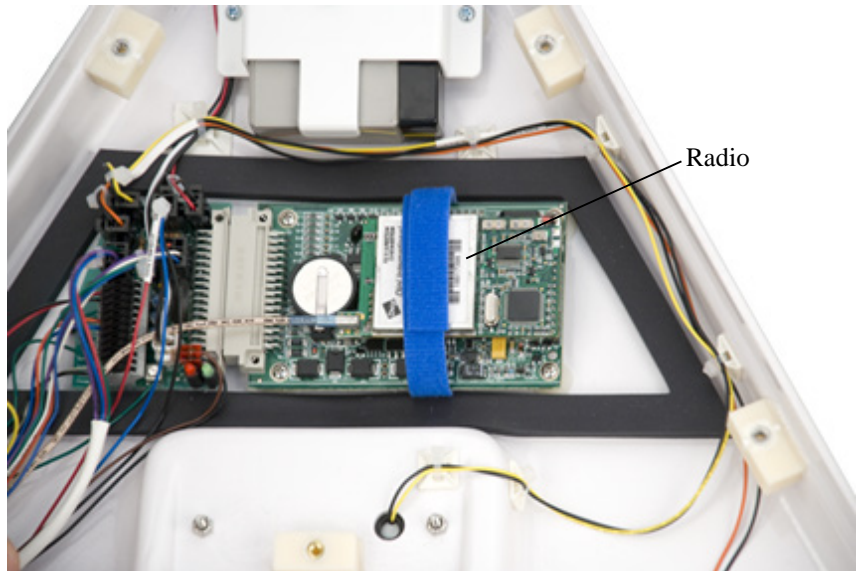


FIGURE 6-10. Radio fastened to the main electronics board with a Velcro strap

- f. Locate the screws on the corners of the main electronics board and touch one finger to one of the screws. Touching the screw will ground any electrostatic energy difference between you and the weather station main electronics board. Do not be concerned as this will not shock you or create a spark.

- g. Carefully remove the Velcro strap from the spread spectrum radio board but do not pull it from under the main electronics board (FIGURE 6-11). The board is additionally retained by connector tension at two connectors below the board. Grasp the edges of the spread spectrum radio board with your free hand and carefully pull it off of the main electronics board.



FIGURE 6-11. Removing the Velcro strap

- h. Your replacement spread spectrum radio was shipped in a special ESD protective bag. Remove the replacement radio from this bag and put the radio you removed into the same ESD bag.
2. Spread Spectrum Radio Replacement:
 - a. The replacement radio will have the main carrier frequency printed on the white label with the word MaxStream. It will be either 900 MHz or 2.4 GHz. Verify that the carrier frequency is the same as that indicated on the spread spectrum radio you removed before proceeding further. If it is not, and you are not intentionally changing the radio frequencies in both the weather station and the radio base station (they must be the same frequency), then contact Campbell Scientific immediately.
 - b. Once the radio frequency has been verified, orient the spread spectrum radio board so that the main electronics board connectors will mate with the proper pins on the bottom of the radio board. Press the spread spectrum radio board into its mating connectors until it is firmly seated, and then tightly attach the Velcro board retaining strap.
 - c. Place the two sections of the weather station main body together, making sure that none of the wiring bundles will be crushed by the edges or by the seven housing screws when the two sections are secured with screws.

- d. Reinstall and tighten the seven screws that hold the weather station main body sections together.
3. System Test:
 - a. Turn on the weather station power switch and initiate communications with your weather station.
 - b. Verify that the sensors are reporting values.
 - c. Reinstall the weather station on its mast, and reconnect the ground and power wires.

Appendix A. TurfWeather Equipment

The following equipment is available from Campbell Scientific. Contact customer service for questions concerning the use of the following equipment.

A.1 Communications Options

A.1.1 17394 Serial-to-USB Adapter

The 17394 Serial-to-USB Adapter is required if your computer has a USB port to communicate with the TurfWeather weather station. The 17394 is a Universal Serial Bus (USB) converter that provides a plug and play RS-232 serial connection to a USB input on a computer. Data rates up to 230 kbps are supported.



The 17394 includes:

- Universal Serial Bus (USB) converter with a 1 meter cable
- Software (supports Windows XP, Vista, 7, 8, and Mac OS X operating systems)

NOTE

This product is commercially produced and may not always be available in this specific configuration. Campbell Scientific may substitute a part of equal or greater value if this device is discontinued by the manufacturer.

A.2 Power Supplies

A.2.1 16851 5 W Solar Panel Kit

This solar panel recharges the weather station internal battery (see Section [5.4.5, SP5 Solar Panel Installation \(p. 21\)](#)). It has a 72 sq inch surface area and produces 5 watts, at a peak of 17.1 volts.



The 16851 includes:

- 5 W solar panel
- Mounting hardware

NOTE

This solar panel is recommended if your site Latitude is greater than 40°, and/or the site experiences extended periods of night, evening, or overcast skies. Contact customer service if there are questions regarding the selection of the proper solar panel kit to use with your weather station.

A.2.2 16876 AC Converter

The 16876 recharges the weather station battery by converting 110-220 Vac, 50/60 Hz power to 18 Vdc. The 16876 must be installed in a non-condensing environment or a weatherproof enclosure.



The 16876 includes

- UL-approved, AC/DC converter with US Standard plug prongs
- 6.2 meter (20 foot), UV resistant waterproof cable with an environmental connector for connecting to the weather station.

A.3 Mounting/Installation Kits

A.3.1 16776 Tripod/Mast Assembly

The 16776 tripod/mast assembly provides a stable support for the weather station and is suitable for ground installations (see Section 5.4.1, *Assemble the 16776 Tripod (p. 15)*, for 16776 installation procedures).



The 16776 includes:

- Tripod
- Mast that places the weather station wind sensors at a height of 99 to 156 cm (38 to 60 in)
- Kit that includes (3) tripod feet with hardware, (6) lag bolts (used for rooftop installations only), and (3) sealing pads (used for rooftop installations only)

A.3.2 16770 Tripod Installation Kit

This kit includes equipment that helps you install the weather station to the correct 3-axis vertical orientation and to align the station to the magnetic North (see Section 5.4.1, *Assemble the 16776 Tripod (p. 15)*, for 16776 installation procedures). Using the 16770 to properly orient the weather station helps assure accurate measurements.



The 16770 includes:

- Multi-axis bubble level
- Compass
- Rubber band for attaching the bubble level to the tripod mast

A.3.3 16773—Tripod Stake Kit

The 16773 is for anchoring the tripod to the soil. It is intended for temporary installations and sites that experience light to moderate wind speeds (see Section 5.4.1, *Assemble the 16776 Tripod (p. 15)*, for 16776 installation procedures).



The 16773 includes:

- (3) 1.27 cm (1/2 in) diameter solid steel spikes with a welded hammer cap on one end

CAUTION

Sites that may experience high wind speeds should not use this kit. For those sites, anchor the tripod with bolts and guy-wires fastened to a concrete pad or other permanent base.

A.3.4 16771—Tripod Mast Extension

The 16771 extension fits into a 1/4-inch diameter post and is used to increase the height of the weather station wind sensors (see Section 5.4.1, *Assemble the 16776 Tripod (p. 15)*, for 16776 installation procedures). When used with the

16776, one extension provides a wind sensor height of 179 to 231 cm (69 to 89 in). A second 16771 can be used to provide a wind sensor height of 255 to 312 cm (98 to 120 in).



The 16771 includes:

- 32.5 cm (1/4 in) OD, 89 cm (35 in) long steel post with one end crimped

CAUTION

- a. Do not use more than two 16771 extensions with the 16776 Tripod Assembly.
- b. When two 16771 extensions are used, the 16772 Guy-wire Kit should also be used.

A.3.5 16772—Tripod Guy-wire Kit

The 16772 is used to increase the tripod's stability (see Section 5.4.3, *16772 Guy-Wire Kit Installation* (p. 17)). It is intended for permanent installations, installations subject to consistently high wind speeds, or 16776 tripods using two mast extensions.



The 16772 includes:

- Plastic-coated, steel guy-wire cable
- Bracket for securing guy-wires to the 16776 mast
- (3) S-hooks
- (3) turnbuckles
- (6) clamps

A.3.6 16775—Tripod Grounding Kit

The 16775 provides hardware needed to properly ground the weather station and tripod. Properly grounding the station prevents electrical surges and lightning from damaging the weather station (see Section 5.4.6, *16775 Ground Kit Installation* (p. 22)).



The 16775 includes:

- 91.4 cm (36 in) long copper sheathed steel electrical ground rod
- Electrical couplings for connection to the ground rod and tripod
- 5 ft length of plastic-coated, #4 stranded copper cable
- 3 ft length of 14 AWG stranded copper wire with a connection lug on one end

CAUTION

- a. Because proper grounding of the system is required for both personal safety and reliable system function, we recommend a qualified electrician install the grounding kit.
 - b. If the station is not properly grounded, a computer connected to the weather station can also be damaged by electrical surges.
 - c. This kit is for ground installations only. A qualified electrician should design and install and the grounding system for a roof mounted station.
-

Campbell Scientific Companies

Campbell Scientific, Inc.

815 West 1800 North
Logan, Utah 84321
UNITED STATES

www.campbellsci.com • info@campbellsci.com

Campbell Scientific Canada Corp.

14532 – 131 Avenue NW
Edmonton AB T5L 4X4
CANADA

www.campbellsci.ca • dataloggers@campbellsci.ca

Campbell Scientific Africa Pty. Ltd.

PO Box 2450
Somerset West 7129
SOUTH AFRICA

www.campbellsci.co.za • cleroux@csafrica.co.za

Campbell Scientific Centro Caribe S.A.

300 N Cementerio, Edificio Breller
Santo Domingo, Heredia 40305
COSTA RICA

www.campbellsci.cc • info@campbellsci.cc

Campbell Scientific Southeast Asia Co., Ltd.

877/22 Nirvana@Work, Rama 9 Road
Suan Luang Subdistrict, Suan Luang District
Bangkok 10250
THAILAND

www.campbellsci.asia • info@campbellsci.asia

Campbell Scientific Ltd.

Campbell Park
80 Hathern Road
Shepshed, Loughborough LE12 9GX
UNITED KINGDOM

www.campbellsci.co.uk • sales@campbellsci.co.uk

Campbell Scientific Australia Pty. Ltd.

PO Box 8108
Garbutt Post Shop QLD 4814
AUSTRALIA

www.campbellsci.com.au • info@campbellsci.com.au

Campbell Scientific Ltd.

3 Avenue de la Division Leclerc
92160 ANTONY
FRANCE

www.campbellsci.fr • info@campbellsci.fr

Campbell Scientific (Beijing) Co., Ltd.

8B16, Floor 8 Tower B, Hanwei Plaza
7 Guanghua Road
Chaoyang, Beijing 100004
P.R. CHINA

www.campbellsci.com • info@campbellsci.com.cn

Campbell Scientific Ltd.

Fahrenheitstraße 13
28359 Bremen
GERMANY

www.campbellsci.de • info@campbellsci.de

Campbell Scientific do Brasil Ltda.

Rua Apinagés, nbr. 2018 – Perdizes
CEP: 01258-00 – São Paulo – SP
BRASIL

www.campbellsci.com.br • vendas@campbellsci.com.br

Campbell Scientific Spain, S. L.

Avda. Pompeu Fabra 7-9, local 1
08024 Barcelona
SPAIN

www.campbellsci.es • info@campbellsci.es

Please visit www.campbellsci.com to obtain contact information for your local US or international representative.