

INSTRUCTION MANUAL



LR4 Four Channel Latching Relay Module

Revision: 6/12



Copyright © 2010-2012
Campbell Scientific, Inc.

Warranty

“PRODUCTS MANUFACTURED BY CAMPBELL SCIENTIFIC, INC. are warranted by Campbell Scientific, Inc. (“Campbell”) to be free from defects in materials and workmanship under normal use and service for twelve (12) months from date of shipment unless otherwise specified in the corresponding Campbell pricelist or product manual. Products not manufactured, but that are re-sold by Campbell, are warranted only to the limits extended by the original manufacturer. Batteries, fine-wire thermocouples, desiccant, and other consumables have no warranty. Campbell's obligation under this warranty is limited to repairing or replacing (at Campbell's option) defective products, which shall be the sole and exclusive remedy under this warranty. The customer shall assume all costs of removing, reinstalling, and shipping defective products to Campbell. Campbell will return such products by surface carrier prepaid within the continental United States of America. To all other locations, Campbell will return such products best way CIP (Port of Entry) INCOTERM® 2010, prepaid. This warranty shall not apply to any products which have been subjected to modification, misuse, neglect, improper service, accidents of nature, or shipping damage. This warranty is in lieu of all other warranties, expressed or implied. The warranty for installation services performed by Campbell such as programming to customer specifications, electrical connections to products manufactured by Campbell, and product specific training, is part of Campbell's product warranty. **CAMPBELL EXPRESSLY DISCLAIMS AND EXCLUDES ANY IMPLIED WARRANTIES OF MERCHANTABILITY OR FITNESS FOR A PARTICULAR PURPOSE.** Campbell is not liable for any special, indirect, incidental, and/or consequential damages.”

Assistance

Products may not be returned without prior authorization. The following contact information is for US and international customers residing in countries served by Campbell Scientific, Inc. directly. Affiliate companies handle repairs for customers within their territories. Please visit www.campbellsci.com to determine which Campbell Scientific company serves your country.

To obtain a Returned Materials Authorization (RMA), contact CAMPBELL SCIENTIFIC, INC., phone (435) 227-9000. After an applications engineer determines the nature of the problem, an RMA number will be issued. Please write this number clearly on the outside of the shipping container. Campbell Scientific's shipping address is:

CAMPBELL SCIENTIFIC, INC.

RMA# _____
815 West 1800 North
Logan, Utah 84321-1784

For all returns, the customer must fill out a "Statement of Product Cleanliness and Decontamination" form and comply with the requirements specified in it. The form is available from our web site at www.campbellsci.com/repair. A completed form must be either emailed to repair@campbellsci.com or faxed to (435) 227-9106. Campbell Scientific is unable to process any returns until we receive this form. If the form is not received within three days of product receipt or is incomplete, the product will be returned to the customer at the customer's expense. Campbell Scientific reserves the right to refuse service on products that were exposed to contaminants that may cause health or safety concerns for our employees.

LR4 Table of Contents

PDF viewers: These page numbers refer to the printed version of this document. Use the PDF reader bookmarks tab for links to specific sections.

1. General Description	1
2. Specifications	1
3. Relay Details	2
4. Contact Details	2
4.1 Types	2
4.2 Relay Contact Life	3
5. Manual Toggle Control	3
6. LED Indicators	4
7. Using SDI-12	4
7.1 SDI-12 Wiring	4
7.2 SDI-12 Addresses	5
7.3 SDI-12 Commands	5
7.4 SDI-12 Programming Examples for CRBasic Datalogger	7
7.4.1 Reading Relay Status Values	7
7.4.2 Setting Relay Values	7
7.4.3 CR200(X) Programming	7
7.5 Edlog Set Relay Example	8
8. Using Modbus	9
8.1 Wiring for Modbus	9
8.1.1 RS-232	9
8.1.2 RS-485	10
8.2 Modbus Baud Rate	11
8.3 Modbus Mode	11
8.4 Modbus Address	11
8.5 Modbus Supported Commands	11
8.6 Modbus Operation	11
9. Firmware Update Procedure	12

List of Figures

- 1. LR4 Latching Relay Module..... 2
- 2. Form A - State = 1 2
- 3. Form A - State = 0 3
- 4. Form C - State = 1..... 3
- 5. Form C - State = 0..... 3
- 6. Communication Jumpers..... 9
- 7. Program Mode Jumper..... 12

List of Tables

- 1. SDI-12 Wiring 4
- 2. Modbus/RS-232 Wiring..... 10
- 3. Modbus/RS-485 Wiring..... 10

LR4 Four Channel Latching Relay Module

1. General Description

The LR4 module uses latching relays that provide the following benefits:

- Low power consumption

Once the control module changes the state of the relay by applying power to a coil, power can then be removed as the relay mechanically latches its state. Conventional relays require the power to be continuously present to hold a relay in one of its states.

- Relay state is non-volatile

Once a relay is set to a desired state, the relay will remain in that state even if power is lost to the control module. The only way to change the state of a relay is to send a valid command that instructs the relay state to be changed or by using the manual toggle button.

2. Specifications

Supply Voltage:	9 to 30 Vdc
Power Consumption	
Quiescent:	< 2.0 mA
Peak:	< 250 mA
Operating Temperature:	-40° to +60°C
Relay Type:	Latching
Communications Hardware:	SDI-12, RS-232, RS-485
Protocol:	SDI-12 Version 1.3 or ModBus via RS-232/RS-485 at 19,200 bps
Digital I/O Input Voltage	
Maximum:	+20 Vdc
Minimum:	-12 Vdc
Dimensions:	17.0 x 6.1 x 3.7 cm (6.7 x 2.4 x 1.5 in)
Weight:	0.48 kg (1.05 lb)

3. Relay Details

Relay #1 and Relay #2

Contacts: 2 independent Form A (SPST)
Maximum Voltage Ratings: 30 Vdc / 30 Vac
Maximum Current: Not to exceed 100 VA or 5 A

Relay #3 and Relay #4

Contacts: 2 independent Form C (SPDT)
Maximum Voltage Ratings: 30 Vdc / 30 Vac
Maximum Current: Not to exceed 60 VA or 2 A



FIGURE 1. LR4 Latching Relay Module

4. Contact Details

4.1 Types

There are two different contact types on the LR4. One type is referred to as a Form A and the second is referred to as a Form C. Relays #1 and #2 are type Form A and Relays #3 and #4 are type Form C. The following figures outline the differences:

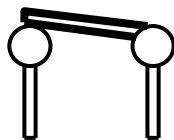

FIGURE 2. Form A - State = 1

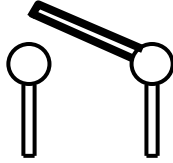

FIGURE 3. Form A - State = 0

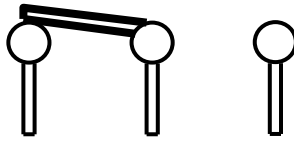

FIGURE 4. Form C - State = 1

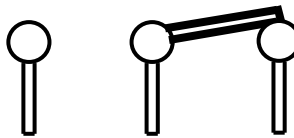

FIGURE 5. Form C - State = 0

4.2 Relay Contact Life

The expected life of the relays under no load conditions is 50 million operations. Under load, the life expectancy is reduced to 100,000 operations.

Inductive loads can further reduce the life expectancy of the relay contact. Proper signal conditioning (clamping diodes) should be considered for inductive loads.

5. Manual Toggle Control

There is one Manual Toggle push button for each relay. The state of a relay can be changed by pressing the corresponding button and holding it in place for 2 seconds. If a relay is in the 1 state when a button is pressed, the corresponding LED will turn on; two seconds later the user will see the LED go off once the relay has changed to the 0 state. In a quiet environment, a click can also be heard when the relay changes state. Likewise, if an LED is in the 0 state, the corresponding LED will be off when a button is pressed and then turn on once the relay has gone to the 1 state. The button must be released and depressed again to change the state again.

To conserve power, the indicating LEDs flash briefly once every 5 seconds. A brief momentary push (less than 1 second) of any button will cause the control module to turn on any LED whose relay is in the 1 state for several seconds.

Only one button should be pressed at a time. Once a relay is controlled manually, the relay remains in that state until a command or button is used to change the relay state.

6. LED Indicators

Five LEDs are on the control module. The main status LED indicates a successful power up by turning on for one second. Rapid flashing for approximately 3 seconds indicates a power-up problem. When the status LED is on, any of the contacts that are in the 1 state will also have its LED on.

In normal operation, the status LED briefly flashes once every 5 seconds. Any contact in the 1 state will have its LED flash with the status LED. A brief button press can be used to activate the LEDs for a longer period of time to observe the relay states. The button press must be less than 1 second to avoid toggling any of the relays.

7. Using SDI-12

Contemporary dataloggers that support the SDI-12 protocol are the CR200X-series, CR800, CR850, CR1000, CR3000, and CR5000. Retired dataloggers that support the SDI-12 protocol include the CR200-series, CR510, CR10(X), and CR23X.

7.1 SDI-12 Wiring

When the LR4 is controlled via the SDI-12 protocol, the RX/B terminal is not connected. Often, the DIG I/O terminal is also not connected. The state of the DIG I/O terminal can be read using SDI-12; it is meant to handle some custom applications (contact Campbell Scientific for more information).

For SDI-12 communications, the CABLE3CBL three-conductor cable is recommended to connect the LR4 to the datalogger when the DIG I/O port is not used. The CABLE4CBL four-conductor cable is recommended when using the DIG I/O port. Table 1 shows the datalogger connections.

CAUTION Power-off the system before wiring the LR4.

TABLE 1. SDI-12 Wiring		
LR4 Terminals	Function	Datalogger Terminal
GND	Power ground and shield	G
POWER	Positive dc power source (9-30 Vdc)	12V
SDI-12 /TX/A	SDI-12 signal	Cx (control port)¹
RX /B	Not used	Not used
DIG. I/O (optional)	Readable digital input	Cx (control port)²

¹ Where x is the control port number. Use the dedicated SDI-12 port on CR5000 datalogger.

² Where x is the control port number. Use of DIG I/O is for some custom applications. Contact Campbell Scientific for more information.

7.2 SDI-12 Addresses

The LR4 can be set to one of ten addresses (0 to 9) which allows up to ten LR4 modules to be connected to a single digital I/O channel (control port) of an SDI-12 datalogger.

The LR4 is shipped from the factory with the address set to 0. The address on the LR4 can be changed by sending an SDI-12 change-address command. The change address command can be issued from most SDI-12 recorders. For some Campbell Scientific dataloggers, the SDI-12 transparent mode will need to be entered to change the address.

When it is necessary to use more than one LR4, it is easiest to use a different control port for each LR4 instead of changing the address. If additional control ports are not available, then the address will need to be changed.

To change the address of an LR4 with the default address of 0 to the address of 1, the following command can be sent:

“0A1!”

Only one SDI-12 device should be connected when using the change address command.

7.3 SDI-12 Commands

The SDI-12 protocol has the ability to support various measurement commands. The LR4 supports the commands that are listed in the following table.

The different commands are entered as options in the SDI-12 recorder instruction. The major difference between the various measurement commands are the data values that are returned.

SDI-12 extended commands are used to set a relay to a desired state.

SDI-12 Command	Command Function/Description	Values Returned
aM!	Status All 4 Relays - 0 or 1 State	R1, R2, R3, R4 (4 values)
aM1!	Status Relay #1 - 0 or 1 State	R1
aM2!	Status Relay #2 - 0 or 1 State	R2
aM3!	Status Relay #3 - 0 or 1 State	R3
aM4!	Status Relay #4 - 0 or 1 State	R4
aM5!	LR4 Supply Voltage	V _{Supply} (Volts)
aM6!	Not completed – Do not use	
aM7!	Not completed – Do not use	
aM8 [!]	Dig. I/O input state – 0 or 1	Dig. I/O Input State
aM9 [!]	Not completed – Do not use	

SDI-12 Command	Command Function/Description	Values Returned
aMC! aMCn!	Same as aM!	
aC!	Concurrent Measurements Status All 4 Relays - 0 or 1 State	R1, R2, R3, R4 (4 values)
aCn!	Concurrent Measurements Same as M1 – M8	Output is the Same as M1 – M8
aCC! aCCn!	Concurrent Measurement Commands with Checksum. See aM and aM1- aM8	Output is the same as aM, aM1-aM8 Checksum is added
aD0!	Send Data	Dependent upon command Sent
aV!	Verification command	S1,S2,V,WD S1 = BootRom Signature S2 = Firmware Signature V = Supply Voltage ^{Note1} WD = Watch Dog Errors
aI!	Send Identification	013CAMPBELL LR4 2.0SN SN = <i>Serial number</i> (5 digits)
?!	Address Query	a
aAb!	Change Address command	b is the new address
aXR;0,R1,R2,R3,R4! Extended command	Sets Values of All 4 Relays to either 0 or 1 state Where R1 is 0 or 1 for Relay #1 Where R2 is 0 or 1 for Relay #2 Where R3 is 0 or 1 for Relay #3 Where R4 is 0 or 1 for Relay #4	a Address is returned with a value of 1.
aXR;N,V! Extended command	Set the State of an Individual Relay. N is 1-4 corresponding to Relays #1 to #4, V is 0 or 1 state	a Address is returned with a value of 1.
aR0!	Same as aM!	Same as aM! command
aR1! to aR8!	Same as aM1! to aM8!	Same as M commands

Where a = address of SDI-12 device.

Where n = numbers 1 to 9

7.4 SDI-12 Programming Examples for CRBasic Datalogger

The following CRBasic examples can be used with the CR800, CR850, CR1000, CR3000, and CR5000.

7.4.1 Reading Relay Status Values

The SDI-12 “M” commands can be used to read the status of the LR4 relays. Alternatively to the SDI-12 “M” commands, the LR4 also supports the “R” command. The SDI-12 “R” command is available to sensors that can respond immediately to a measurement request as the LR4 is capable of doing so. This can be advantageous in reducing the execution time for reading information back from the LR4.

'Programming line to Read the state of all 4 relays with an M command
SDI12Recorder(RelayReadState(),1,0,"M!",1.0,0)

'Programming line to Read the state of Relay #3 with an M command
SDI12Recorder(RelayState_3,1,0,"M3!",1.0,0)

'Programming line to Read the state of all 4 relays with an R command
SDI12Recorder(RelayReadState(),1,0,"R!",1.0,0)

'Programming line to Read the state of Relay #3 with an R command
SDI12Recorder(RelayState_3,1,0,"R3!",1.0,0)

7.4.2 Setting Relay Values

Relays on the LR4 can only be set in SDI-12 by using extended commands as follows:

'Set all four relays to the 0 state
SDI12Recorder(SetResult,1,0,"XR;0,0,0,0,0!",1.0,0)

'Set all four relays to the 1 state
SDI12Recorder(SetResult,1,0,"XR;0,1,1,1,1!",1.0,0)

'Set relay #3 to the 0 state
SDI12Recorder(SetResult,1,0,"XR;3,0!",1.0,0)

'Set relay #3 to the 1 state
SDI12Recorder(SetResult,1,0,"XR;3,1!",1.0,0)

7.4.3 CR200(X) Programming

The CR200(X) programming differs from the other CRBasic programming as follows:

- The channel field does not exist.
- The address field does not exist as the address is placed in the first digit of the command.

- The CR200(X) does not support setting all four relays in one command. The individual relay commands can only be used on the CR200(X).

'CR200(X) Set Relay #4 to State 1.
SDI12Recorder(RelayState_4, "OXR;4,1!", 1.0, 0)

7.5 Edlog Set Relay Example

Although this example is for the CR10X datalogger, the CR510 and CR23X are programmed similarly. Edlog dataloggers use Instruction 68 after Instruction 105 to send the extended commands.

```

;A P68 following this P105 sends extended commands
;Use program control to set the Relay3Val variable to either 0 or 1
1: SDI-12 Recorder (P105)
  1: 0          SDI-12 Address
  2: 0          Start Measurement (aM!) ;Leave at zero
  3: 1          Port
  4: 13         Loc [ Relay3Val ] ; This location contains the desired state value
  5: 1.0        Multiplier
  6: 0.0        Offset

2: Extended Parameters 4 Digit (P68)
  1: 88         Option ;Decimal for Character 'X'
  2: 82         Option ;Decimal for Character 'R'
  3: 59         Option ;Decimal for Character ';'
  4: 51         Option ;Decimal for Character '3' (49 for #1, 50 for #2, and 52 for #4 )
  5: 44         Option ;Decimal for Character ','
  6: 128        Option ;Relay state value from input location
  7: 0000       Option
  8: 0000       Option

;Read the state of all 4 relays
3: SDI-12 Recorder (P105)
  1: 0          SDI-12 Address
  2: 0          Start Measurement (aM!)
  3: 1          Port
  4: 1          Loc [ ReadRel1 ]
  5: 1.0        Multiplier
  6: 0.0        Offset

```

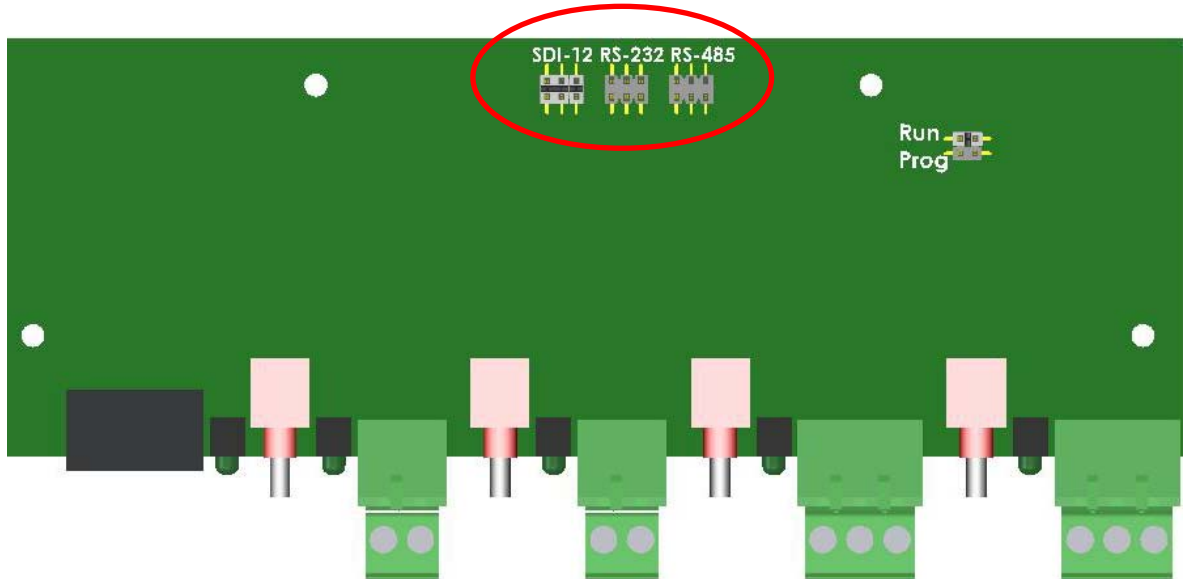

FIGURE 6. Communication Jumpers

8. Using Modbus

The LR4 can operate in a Modbus mode. The three internal jumpers in the LR4 need to be moved from the SDI-12 position to either the RS-232 or the RS-485 position for Modbus operation. By default, the LR4 is shipped with the jumpers set for SDI-12 operation. The jumpers must be moved prior to any connection with an RS-232 or an RS-485 device (see Section 8.1, *Wiring for Modbus*). FIGURE 6. Communication Jumper shows the jumper positions on the PCB.

To move the internal jumpers:

- Ensure that the LR4 is completely disconnected.
- Remove the cover of the LR4 by removing the two Philips screws.

8.1 Wiring for Modbus

8.1.1 RS-232

RS-232 is supported by the CR200(X), CR800, CR850, CR1000, and CR3000 dataloggers.

For the Modbus/RS-232 mode, the CABLE2TP 2-twisted pair cable is recommended to connect the LR4 to the datalogger. Table 2 shows the datalogger connections.

CAUTION

Your system should be powered down before wiring the LR4.

TABLE 2. Modbus/RS-232 Wiring		
LR4 Terminals	Description	Datalogger Terminal
GND	Power Ground and Shield	G
POWER	Positive DC Power Source (9-30VDC)	12V
SDI-12 /TX/A	Modbus master RS-232 Receive	COM port (Rx)
RX/B	Modbus master RS-232 Transmit	COM port (Tx)
DIG I/O	Not used	Not used

8.1.2 RS-485

The CR800, CR850, CR1000, CR3000, CR510, CR10X, and CR23X dataloggers can use Modbus via RS-485. Please note that the CR510 and CR10X require a Modbus operating system.

With the RS-485 mode, one MD485 Multidrop Modem is required. The MD485 connects to the LR4 via the CABLE2TP cable and connects to the datalogger via the 18663 Null Modem Cable. Also required is the 14291 Field Power Cable to connect the LR4 power terminals to the MD485.

The DIG I/O port on the LR4 is not used. Table 3 shows the wiring. For more information about using the MD485, refer to the MD485 Multidrop Modem’s manual.

CAUTION

Your system should be powered down before wiring the LR4.

TABLE 3. Modbus/RS-485 Wiring			
LR4 Terminals	Description	MD485 Terminal	14291 Field Cable Wire Color
GND	Power Ground and Shield		Black
POWER	Positive DC Power Source (9-30VDC)	N/A	Red
SDI-12 /TX/A	Modbus master (RS-485A)	A	N/A
RX /B	Modbus master (RS-485B)	B	N/A
DIG. I/O	Not Used		

8.2 Modbus Baud Rate

The default baud rate is 19200. Other baud rates are possible. Consult the factory if other baud rates are required.

8.3 Modbus Mode

The LR4 supports RTU mode only; the ASCII mode is currently not implemented.

8.4 Modbus Address

The default address assigned to the LR4 is 51. Other addresses can be assigned to the LR4 by writing the new desired address to register 9999. Once this is done, the LR4 will only respond to the new address.

If the address is unknown, the broadcast address (0) can be used to set the address to a valid range (1 - 247).

8.5 Modbus Supported Commands

Read Holding Registers (0x03)

Write Single Register (0x06)

Write Multiple registers (0x10)

8.6 Modbus Operation

All I/O on the LR4 module are treated as registers. The following are the register assignments for the LR4:

0001 – Relay #1

0002 – Relay #2

0003 – Relay #3

0004 – Relay #4

0005 – External I/O value (currently set as input-only)

0006 – LR4 supply voltage value in mV. 12250 = 12.25 volts

0007 – Signature of the Boot ROM

0008 – Signature of the Operating Firmware

0009 – The serial number of the LR4

9999 – Can be written to in order to change the LR4's Modbus address

All of the Modbus registers on the LR4 module are unsigned integers (16-bit values / single register).

9. Firmware Update Procedure

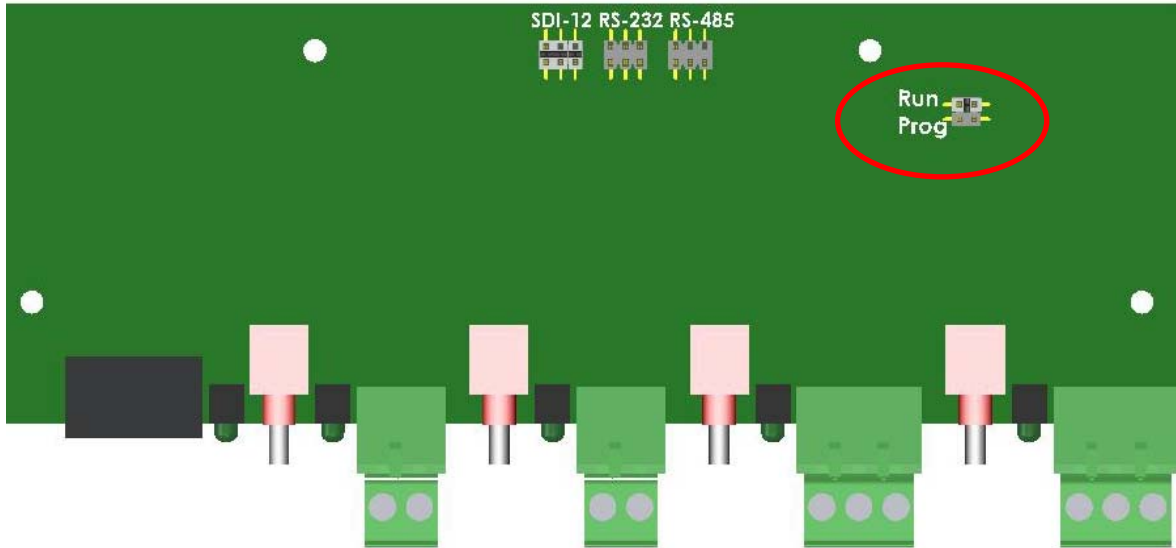

FIGURE 7. Program Mode Jumper

The firmware on the LR4 can be updated by using a terminal program such as Hyperterminal. The LR4 contains an internal female DB-9 connector to facilitate an RS-232 connection.

Firmware updates should only be performed at an appropriate workstation with static control procedures in place. Failure to follow the procedures may cause damage to the device.

- Ensure that the LR4 is completely disconnected.
- Remove the cover of the LR4 by removing the two Philips screws.
- Locate the program mode jumper and move the jumper from *Run* to *Prog* as shown in Figure 7.
- Connect the LR4 to power and ground only (make no other connections as doing so may interfere with programming).
- Once power is applied, the status LED should remain on.
- Connect the computer to the RS-232 connector inside the LR4.
- Set up Hyperterminal or the communications program that is being used as follows:
 - Baud Rate: 38400
 - Data Bits: 8
 - Parity: None
 - Stop Bits: 1
 - Flow control: XON/XOFF
 - 25-ms line delay (under ASCII setup)

- From the Hyperterminal menu, select Transfer → Send Text File.
- Select the new download text file and the transfer should begin.
- Initially, the LED should remain constantly on. When data transfer begins, the LED will flash rapidly with each line that is reprogrammed.
- Upon completion, the LED will remain steadily on again.
- If there are any errors, the LED will flash to indicate that an error occurred.
- If an error is indicated by a flashing LED, cycle power to the LR4 and attempt the reprogram process again.
- After the reprogramming is successful, disconnect the LR4 from the power supply.
- Move the jumper back from the Program position to the Run position.
- Re-assemble the device.
- Verify operation of the LR4.

Campbell Scientific Companies

Campbell Scientific, Inc. (CSI)

815 West 1800 North
Logan, Utah 84321
UNITED STATES

www.campbellsci.com • info@campbellsci.com

Campbell Scientific Africa Pty. Ltd. (CSAf)

PO Box 2450
Somerset West 7129
SOUTH AFRICA

www.csafrica.co.za • cleroux@csafrica.co.za

Campbell Scientific Australia Pty. Ltd. (CSA)

PO Box 8108
Garbutt Post Shop QLD 4814
AUSTRALIA

www.campbellsci.com.au • info@campbellsci.com.au

Campbell Scientific do Brazil Ltda. (CSB)

Rua Luisa Crapsi Orsi, 15 Butantã
CEP: 005543-000 São Paulo SP BRAZIL

www.campbellsci.com.br • suporte@campbellsci.com.br

Campbell Scientific Canada Corp. (CSC)

11564 - 149th Street NW
Edmonton, Alberta T5M 1W7
CANADA

www.campbellsci.ca • dataloggers@campbellsci.ca

Campbell Scientific Centro Caribe S.A. (CSCC)

300 N Cementerio, Edificio Breller
Santo Domingo, Heredia 40305
COSTA RICA

www.campbellsci.cc • info@campbellsci.cc

Campbell Scientific Ltd. (CSL)

Campbell Park
80 Hathern Road
Shepshed, Loughborough LE12 9GX
UNITED KINGDOM

www.campbellsci.co.uk • sales@campbellsci.co.uk

Campbell Scientific Ltd. (France)

3 Avenue de la Division Leclerc
92160 ANTONY
FRANCE

www.campbellsci.fr • info@campbellsci.fr

Campbell Scientific Spain, S. L.

Avda. Pompeu Fabra 7-9, local 1
08024 Barcelona
SPAIN

www.campbellsci.es • info@campbellsci.es

Please visit www.campbellsci.com to obtain contact information for your local US or international representative.