

INSTRUCTION MANUAL



WindSonic1 and WindSonic4 Two-Dimensional Sonic Anemometers

Revision: 4/16



Copyright © 2004-2016
Campbell Scientific, Inc.

Limited Warranty

“Products manufactured by CSI are warranted by CSI to be free from defects in materials and workmanship under normal use and service for twelve months from the date of shipment unless otherwise specified in the corresponding product manual. (Product manuals are available for review online at www.campbellsci.com.) Products not manufactured by CSI, but that are resold by CSI, are warranted only to the limits extended by the original manufacturer. Batteries, fine-wire thermocouples, desiccant, and other consumables have no warranty. CSI’s obligation under this warranty is limited to repairing or replacing (at CSI’s option) defective Products, which shall be the sole and exclusive remedy under this warranty. The Customer assumes all costs of removing, reinstalling, and shipping defective Products to CSI. CSI will return such Products by surface carrier prepaid within the continental United States of America. To all other locations, CSI will return such Products best way CIP (port of entry) per Incoterms ® 2010. This warranty shall not apply to any Products which have been subjected to modification, misuse, neglect, improper service, accidents of nature, or shipping damage. This warranty is in lieu of all other warranties, expressed or implied. The warranty for installation services performed by CSI such as programming to customer specifications, electrical connections to Products manufactured by CSI, and Product specific training, is part of CSI’s product warranty. **CSI EXPRESSLY DISCLAIMS AND EXCLUDES ANY IMPLIED WARRANTIES OF MERCHANTABILITY OR FITNESS FOR A PARTICULAR PURPOSE. CSI hereby disclaims, to the fullest extent allowed by applicable law, any and all warranties and conditions with respect to the Products, whether express, implied or statutory, other than those expressly provided herein.”**

Assistance

Products may not be returned without prior authorization. The following contact information is for US and international customers residing in countries served by Campbell Scientific, Inc. directly. Affiliate companies handle repairs for customers within their territories. Please visit www.campbellsci.com to determine which Campbell Scientific company serves your country.

To obtain a Returned Materials Authorization (RMA), contact CAMPBELL SCIENTIFIC, INC., phone (435) 227-9000. After an application engineer determines the nature of the problem, an RMA number will be issued. Please write this number clearly on the outside of the shipping container. Campbell Scientific's shipping address is:

CAMPBELL SCIENTIFIC, INC.

RMA# _____
815 West 1800 North
Logan, Utah 84321-1784

For all returns, the customer must fill out a "Statement of Product Cleanliness and Decontamination" form and comply with the requirements specified in it. The form is available from our website at www.campbellsci.com/repair. A completed form must be either emailed to repair@campbellsci.com or faxed to (435) 227-9106. Campbell Scientific is unable to process any returns until we receive this form. If the form is not received within three days of product receipt or is incomplete, the product will be returned to the customer at the customer's expense. Campbell Scientific reserves the right to refuse service on products that were exposed to contaminants that may cause health or safety concerns for our employees.

Safety

DANGER — MANY HAZARDS ARE ASSOCIATED WITH INSTALLING, USING, MAINTAINING, AND WORKING ON OR AROUND TRIPODS, TOWERS, AND ANY ATTACHMENTS TO TRIPODS AND TOWERS SUCH AS SENSORS, CROSSARMS, ENCLOSURES, ANTENNAS, ETC. FAILURE TO PROPERLY AND COMPLETELY ASSEMBLE, INSTALL, OPERATE, USE, AND MAINTAIN TRIPODS, TOWERS, AND ATTACHMENTS, AND FAILURE TO HEED WARNINGS, INCREASES THE RISK OF DEATH, ACCIDENT, SERIOUS INJURY, PROPERTY DAMAGE, AND PRODUCT FAILURE. TAKE ALL REASONABLE PRECAUTIONS TO AVOID THESE HAZARDS. CHECK WITH YOUR ORGANIZATION'S SAFETY COORDINATOR (OR POLICY) FOR PROCEDURES AND REQUIRED PROTECTIVE EQUIPMENT PRIOR TO PERFORMING ANY WORK.

Use tripods, towers, and attachments to tripods and towers only for purposes for which they are designed. Do not exceed design limits. Be familiar and comply with all instructions provided in product manuals. Manuals are available at www.campbellsci.com or by telephoning (435) 227-9000 (USA). You are responsible for conformance with governing codes and regulations, including safety regulations, and the integrity and location of structures or land to which towers, tripods, and any attachments are attached. Installation sites should be evaluated and approved by a qualified engineer. If questions or concerns arise regarding installation, use, or maintenance of tripods, towers, attachments, or electrical connections, consult with a licensed and qualified engineer or electrician.

General

- Prior to performing site or installation work, obtain required approvals and permits. Comply with all governing structure-height regulations, such as those of the FAA in the USA.
- Use only qualified personnel for installation, use, and maintenance of tripods and towers, and any attachments to tripods and towers. The use of licensed and qualified contractors is highly recommended.
- Read all applicable instructions carefully and understand procedures thoroughly before beginning work.
- Wear a **hardhat** and **eye protection**, and take **other appropriate safety precautions** while working on or around tripods and towers.
- **Do not climb** tripods or towers at any time, and prohibit climbing by other persons. Take reasonable precautions to secure tripod and tower sites from trespassers.
- Use only manufacturer recommended parts, materials, and tools.

Utility and Electrical

- **You can be killed** or sustain serious bodily injury if the tripod, tower, or attachments you are installing, constructing, using, or maintaining, or a tool, stake, or anchor, come in **contact with overhead or underground utility lines**.
- Maintain a distance of at least one-and-one-half times structure height, 20 feet, or the distance required by applicable law, **whichever is greater**, between overhead utility lines and the structure (tripod, tower, attachments, or tools).
- Prior to performing site or installation work, inform all utility companies and have all underground utilities marked.
- Comply with all electrical codes. Electrical equipment and related grounding devices should be installed by a licensed and qualified electrician.

Elevated Work and Weather

- Exercise extreme caution when performing elevated work.
- Use appropriate equipment and safety practices.
- During installation and maintenance, keep tower and tripod sites clear of un-trained or non-essential personnel. Take precautions to prevent elevated tools and objects from dropping.
- Do not perform any work in inclement weather, including wind, rain, snow, lightning, etc.

Maintenance

- Periodically (at least yearly) check for wear and damage, including corrosion, stress cracks, frayed cables, loose cable clamps, cable tightness, etc. and take necessary corrective actions.
- Periodically (at least yearly) check electrical ground connections.

WHILE EVERY ATTEMPT IS MADE TO EMBODY THE HIGHEST DEGREE OF SAFETY IN ALL CAMPBELL SCIENTIFIC PRODUCTS, THE CUSTOMER ASSUMES ALL RISK FROM ANY INJURY RESULTING FROM IMPROPER INSTALLATION, USE, OR MAINTENANCE OF TRIPODS, TOWERS, OR ATTACHMENTS TO TRIPODS AND TOWERS SUCH AS SENSORS, CROSSARMS, ENCLOSURES, ANTENNAS, ETC.

Table of Contents

PDF viewers: These page numbers refer to the printed version of this document. Use the PDF reader bookmarks tab for links to specific sections.

1. Introduction	1
2. Precautions	1
3. Initial Inspection.....	2
3.1 Ships With.....	2
4. QuickStart.....	2
4.1 WindSonic1 <i>Short Cut</i> Tutorial	2
4.2 WindSonic4 <i>Short Cut</i> Tutorial	5
5. Overview	7
6. Specifications.....	8
6.1 Wind Direction.....	8
6.2 Wind Speed.....	8
6.3 General Specifications	8
6.4 Campbell Scientific Factory Default Settings for the WindSonic1.....	9
7. Installation.....	10
7.1 Siting	10
7.2 Mount the Sensor	10
7.3 Wiring	11
7.3.1 Datalogger to WindSonic1 Wiring	11
7.3.2 SDM-SIO1 Wiring.....	12
7.3.3 WindSonic4 Wiring	12
7.4 Datalogger Programming	13
7.4.1 WindSonic1 Programming.....	13
7.5 WindSonic4 Programming.....	14
8. Operation.....	15
8.1 Sensor Configuration	15
8.2 SDI-12 Measurement Details	15
8.2.1 Changing the SDI-12 Address Using <i>LoggerNet</i> and a Datalogger	16
8.2.1.1 CR200(X)-Series Datalogger	16
9. Maintenance and Troubleshooting	17
9.1 Troubleshooting	17
9.2 Maintenance	18

10. Siting References.....18

Appendices

A. Importing *Short Cut Code* Into *CRBasic Editor* ... A-1

B. Example Programs..... B-1

- B.1 WindSonic1 Programs..... B-1
 - B.1.1 CR1000 WindSonic1 Program Using COMn Port..... B-1
 - B.1.1 CR1000 WindSonic1 Program Using SDM-SIO1 B-2
- B.2 WindSonic4 Programs..... B-3
 - B.2.1 CR200X WindSonic4 Program..... B-3
 - B.2.2 CR800 WindSonic4 Program..... B-4

C. WindSonic Orientation..... C-1

- C.1 Determining True North and Sensor Orientation C-1
- C.2 Online Magnetic Declination Calculator..... C-3

D. Updating an Older Program for Measuring a WindSonic1 with the New Settings..... D-1

E. Using the CR6 Datalogger’s CPI/RS-232 Port E-1

Figures

- 6-1. White dot indicating that the WindSonic1 has the newer settings..... 10
- 7-1. WindSonic mounted on a CM202 using pn 17837..... 11
- 8-1. SDI-12 Transparent Mode for a CR200(X) used to change the SDI-12 address from 0 to 1 17
- C-1. Magnetic declination for the conterminous United States (2015) ... C-1
- C-2. A declination angle east of True North (positive) is subtracted from 360 (0) degrees to find True North..... C-2
- C-3. A declination angle west of True North (negative) is subtracted from 0 (360) degrees to find True North..... C-2
- C-4. NOAA web calculator C-3
- C-5. NOAA calculated declination using HTML result format C-4

Tables

- 7-1. WindSonic1 to Datalogger Connections 12
- 7-2. WindSonic1 to SDM-SIO1 Connections..... 12
- 7-3. WindSonic4 to Datalogger Connections 13
- 7-4. CRBasic Datalogger Operating Systems that Support RS-232 Communications and SerialInRecord()..... 14
- 7-5. WindSonic4 Data Format Option 14
- 7-6. Datalogger Operating Systems that Support the SDI-12 “aRo!” Command..... 15
- 8-1. WindSonic1 Output Frequencies..... 15
- 9-1. Gill WindSonic Diagnostic Codes..... 18
- 9-2. Example Datalogger Program Diagnostic Codes 18
- B-1. Wiring for CR1000 Example Program..... B-1

B-2. Wiring for CR1000/SDM-SIO1 Program ExampleB-2
B-3. Wiring for CR200(X) Program ExampleB-3
B-4. Wiring for CR800 Program Example.....B-4
E-1. CPI/RS-232 Connections E-1

CRBasic Examples

B-1. CR1000 WindSonic1 Program Using COMn Port.....B-1
B-2. CR1000 WindSonic1 Program Using SDM-SIO1B-2
B-3. CR200X WindSonic4 Program.....B-3
B-4. CR800 WindSonic4 Program.....B-4
E-1. Program for Using the CPI/RS-232 Port..... E-1

WindSonic1 and WindSonic4 Two-Dimensional Sonic Anemometers

1. Introduction

The WindSonic1 and WindSonic4 are two-dimensional ultrasonic anemometers for measuring wind speed and wind direction. They provide an alternative to traditional mechanical cup and vane or propeller and vane anemometers. Unlike mechanical anemometers, there are no moving parts to be periodically replaced—minimizing routine maintenance costs. These two-dimensional anemometers are manufactured by Gill Instruments, Ltd.

The WindSonic1 and WindSonic4 differ in their output signal. The WindSonic1 outputs an RS-232 signal that can be read by the CR300-series, CR6-series, CR800-series, CR1000, or CR3000 dataloggers. The WindSonic4 outputs an SDI-12 signal that can be read by the CR200(X)-series, CR300-series, CR6-series, CR800-series, CR1000, CR3000, or CR5000 dataloggers.

NOTE

This manual provides information only for CRBasic dataloggers. It is also compatible with our retired Edlog dataloggers. For Edlog datalogger support, see an older manual at www.campbellsci.com/old-manuals or contact a Campbell Scientific application engineer for assistance.

2. Precautions

- READ AND UNDERSTAND the Safety section at the front of this manual.
- The Windsonic1 and WindSonic4 are not recommended for conditions where rime, ice, or horizontal snow will occur. They are not heated.
- The WindSonic is a precision instrument. Please handle it with care.
- If the WindSonic is to be installed at heights over 2 m (6 ft), be familiar with tower safety and follow safe tower climbing procedures.
- DANGER—Use extreme care when working near overhead electrical wires. Check for overhead wires before mounting the WindSonic or before raising a tower.
- WindSonic1's default settings were changed in February 2013. WindSonic1s with newer settings will not work with older programs and Short Cut 3.0 or older. See Section 6.4, *Campbell Scientific Factory Default Settings for the WindSonic1* (p. 9), and Appendix D, *Updating an Older Program for Measuring a WindSonic1 with the New Settings* (p. D-1), for more information.
- Communications between the WindSonic1 and the datalogger will most likely fail if its cable is extended beyond 50 feet.

- For the WindSonic4, the maximum cable length tested by Gill is 91 m (300 ft). The SDI-12 standard specifies that an SDI-12 sensor must be able to use at least 61 m (200 ft) of signal cable. Greater SDI-12 cable lengths are acceptable.
- The black outer jacket of the cable is Santoprene® rubber. This compound was chosen for its resistance to temperature extremes, moisture, and UV degradation. However, this jacket will support combustion in air. It is rated as slow burning when tested according to U.L. 94 H.B. and will pass FMVSS302. Local fire codes may preclude its use inside buildings.

3. Initial Inspection

- Upon receipt of the WindSonic, inspect the packaging and contents for damage. File damage claims with the shipping company. Immediately check package contents against the shipping documentation (see Section 3.1, *Ships With*). Contact Campbell Scientific about any discrepancies.
- The model number and cable length are printed on a label at the connection end of the cable. Check this information against the shipping documents to ensure the expected product and cable length are received.

3.1 Ships With

The WindSonic is shipped with the ResourceDVD and a mounting kit (pn 17387). The mounting kit includes a 34.93 cm (13.75 in) length of tubing (pn 17386), three #6-32 x 0.375 inch pan head screws (pn 505), and a Right Angle Mounting Kit (pn CM220).

4. QuickStart

Short Cut is an easy way to program your datalogger to measure the WindSonic and assign datalogger wiring terminals. *Short Cut* is available as a download on www.campbellsci.com and the *ResourceDVD*. It is included in installations of *LoggerNet*, *PC200W*, *PC400*, or *RTDAQ*.

4.1 WindSonic1 *Short Cut* Tutorial

The following procedure uses *Short Cut* to program the WindSonic1.

1. Open *Short Cut*. Click **New Program**.

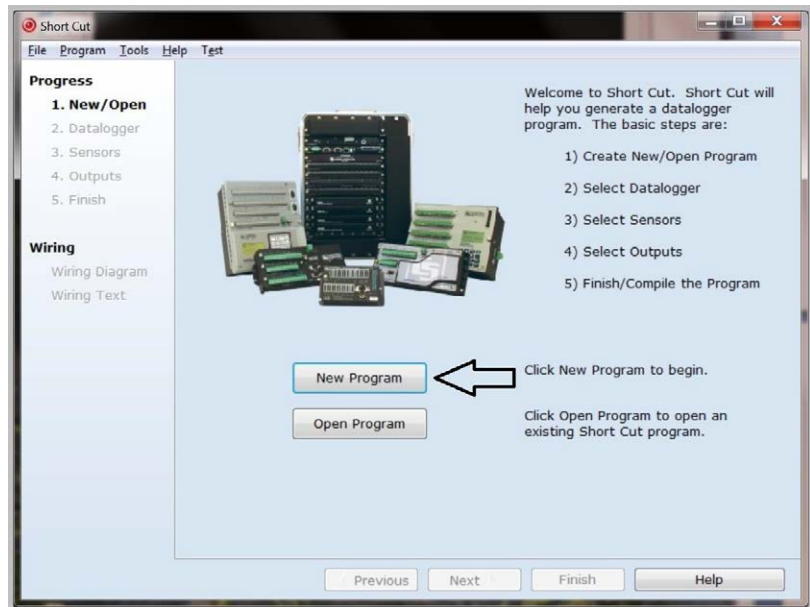

2. Select **Datalogger Model** and **Scan Interval** (default of 5 seconds is OK for most applications). Click **Next**.

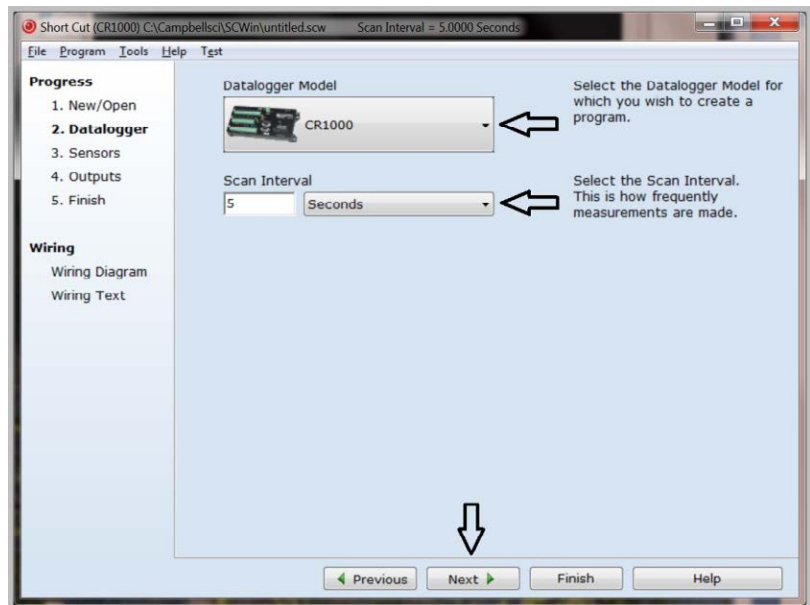

- Under the **Available Sensors and Devices** list, select the **Sensors | Meteorological | Wind Speed & Direction**. Select either **WindSonic1 (RS-232 38.4K baud)** or **WindSonic1 (RS-232 9.6K baud)**. Click  to move the selection to the selected device window. The wind speed defaults to degrees meters per second. This can be changed by clicking the **Wind Speed** box and selecting one of the other options.

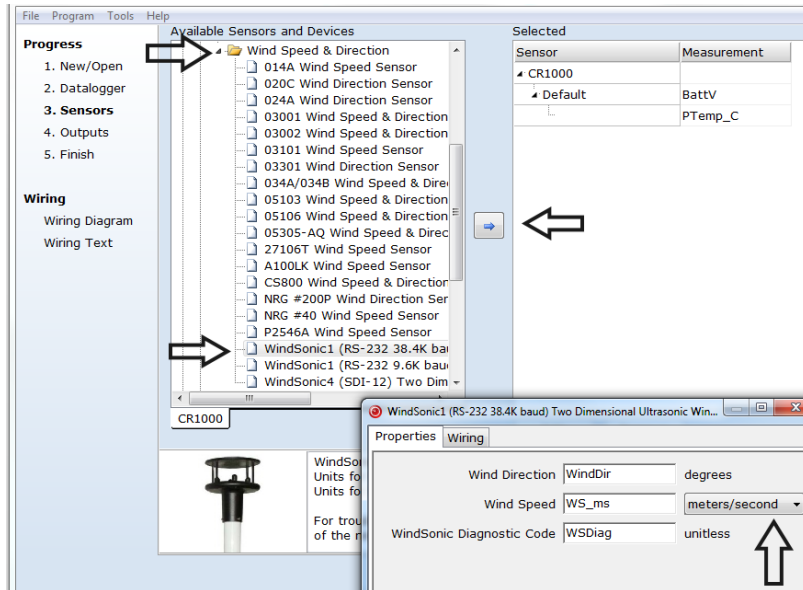

- After selecting the sensor, click **Wiring Diagram** to see how the sensor is to be wired to the datalogger. The wiring diagram can be printed now or after more sensors are added.

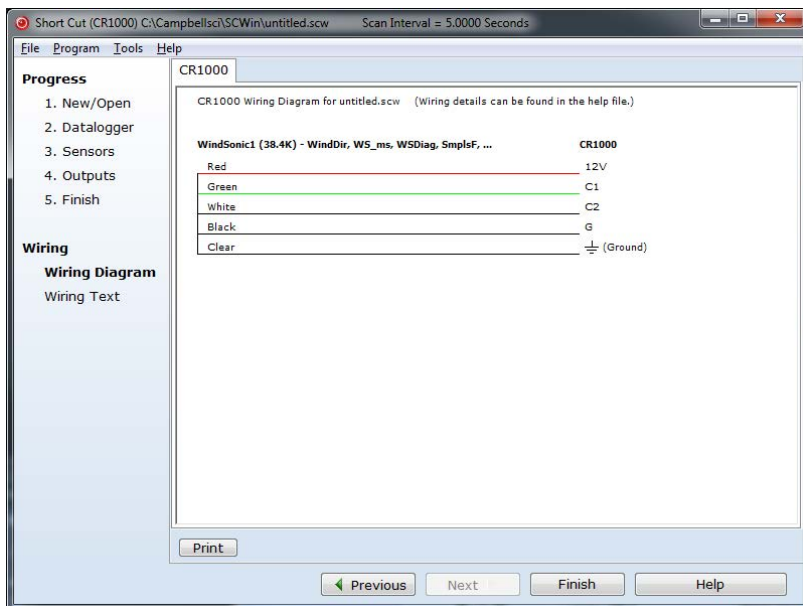

5. Select any other sensors you have, then finish the remaining *Short Cut* steps to complete the program. The remaining steps are outlined in *Short Cut Help*, which is accessed by clicking on **Help | Contents | Programming Steps**.
6. If *LoggerNet*, *PC400*, *RTDAQ*, or *PC200W* is running on your PC, and the PC to datalogger connection is active, you can click **Finish** in *Short Cut* and you will be prompted to send the program just created to the datalogger.
7. If the sensor is connected to the datalogger, as shown in the wiring diagram in step 4, check the output of the sensor in the datalogger support software data display to make sure it is making reasonable measurements.

4.2 WindSonic4 Short Cut Tutorial

The following procedure uses *Short Cut* to program the WindSonic4.

1. Open *Short Cut*. Click **New Program**.
2. Select **Datalogger Model** and **Scan Interval** (default of 5 seconds is OK for most applications). Click **Next**.
3. Under the **Available Sensors and Devices** list, select the **Sensors | Meteorological | Wind Speed & Direction | WindSonic4 (SDI-12) Two Dimensional Ultrasonic Wind Sensor**. Click  to move the selection to the selected device window.

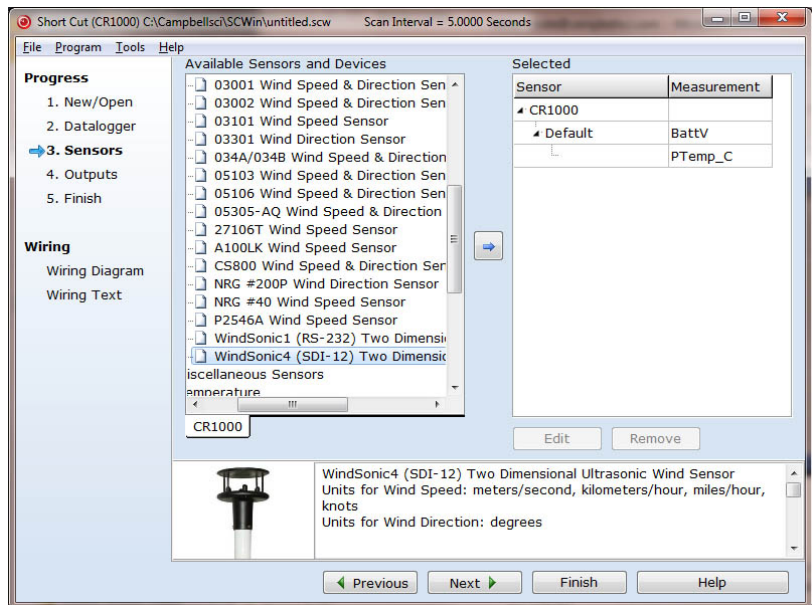

- Define the name of the public variables and SDI-12 Address. Variables default to **WindDir**, **WS_ms**, and **WSDiag** that hold the wind direction measurements, wind speed measurements, and diagnostic code. The **SDI-12 Address** defaults to 0. Select the desired units of measurement for the wind speed. Units default to **meters/seconds**.

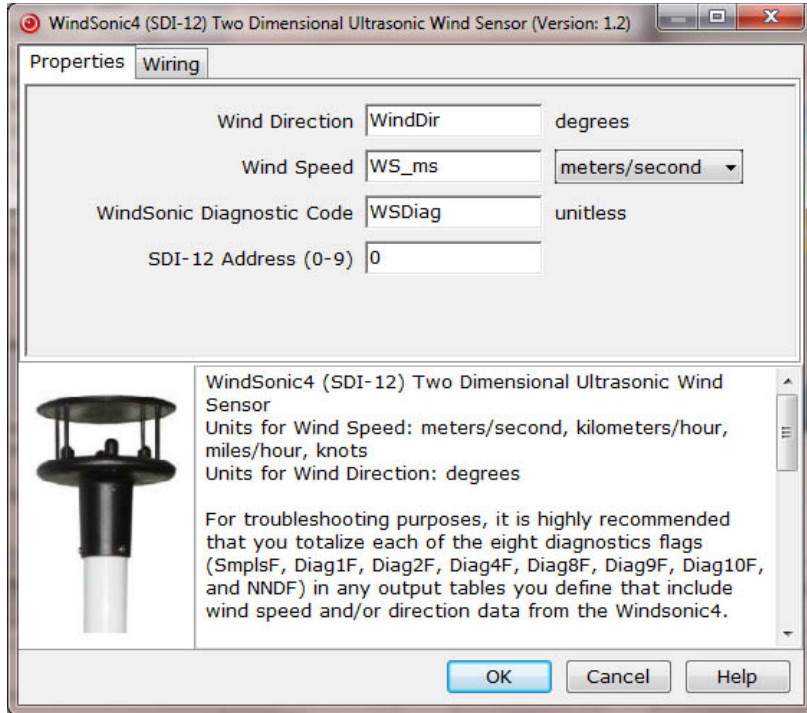

- After selecting the sensor, click **Wiring Diagram** to see how the sensor is to be wired to the datalogger. The wiring diagram can be printed now or after more sensors are added.

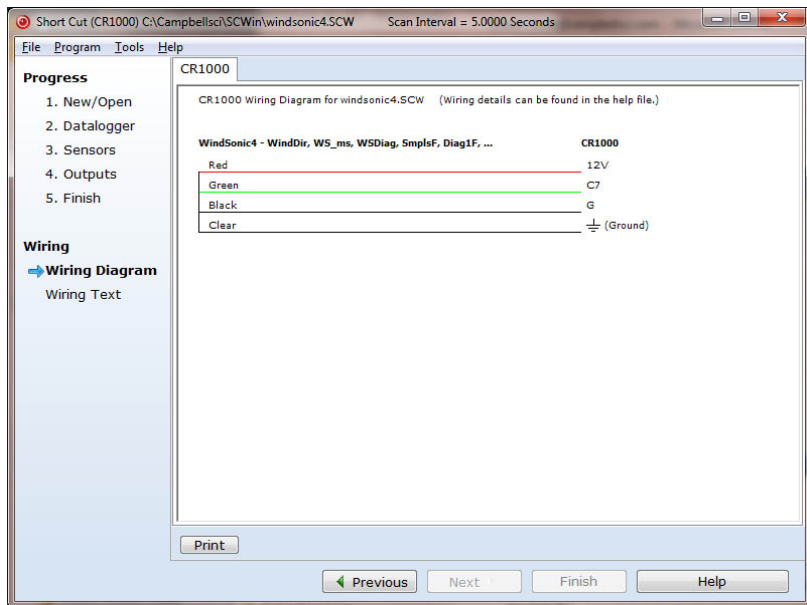

5. Overview

The WindSonic is an ultrasonic anemometer for measuring wind direction and wind speed. It uses two pairs of orthogonally oriented transducers to sense horizontal wind. The transducers bounce the ultrasonic signal from a hood, minimizing the effects of transducer shadowing and flow distortion.

Detailed information on the Gill WindSonic is available in the manual published by Gill Instruments, Ltd. and can be found at www.gill.co.uk/products/anemometer/windsonic.htm. This manual serves as a guide for interfacing the WindSonic to Campbell Scientific dataloggers. The WindSonic is available in two versions. Option 1 WindSonic (WindSonic1) outputs data using the RS-232 interface. Option 4 WindSonic (WindSonic4) outputs data using the SDI-12 interface.

For the CR300-series, CR800-series, CR1000, or CR3000 dataloggers, the WindSonic1 connects to control/serial ports (COMn); two ports make a COMn serial port (for example, C1 and C2 are COM1). For the CR6 series, the WindSonic1 connects to control ports or universal channels configured for serial communication. The maximum number of WindSonic1 anemometers that can be directly connected to the datalogger are:

- 1 (CR300 series)
- 2 (CR800 series)
- 4 (CR1000, CR3000)
- 8 (CR6 series)

Additional WindSonic1 anemometers can be interfaced using an RJ45 terminal block adapter (pn 31897) (CR6 only) or SDM-SIO1 (not compatible with the CR300). Campbell Scientific does not recommend using the CR200(X) series or CR5000 with the WindSonic1 because of their limited serial support using control ports.

Campbell Scientific recommends that the WindSonic4, SDI-12 interface, be used with CR200(X)-series or CR5000 dataloggers. SDI-12 is a three-wire digital interface standard used by processor-based sensors and digital recording devices. The CR300-series, CR6-series, CR800-series, CR1000, and CR3000 dataloggers also support the SDI-12 interface.

The WindSonic includes a user-specified cable to interface to a Campbell Scientific datalogger. The WindSonic's cable can terminate in:

- Pigtails that connect directly to a Campbell Scientific datalogger (option –PT).
- Connector that attaches to a prewired enclosure (option –PW). Refer to www.campbellsci.com/prewired-enclosures for more information.

A serial cable (WINDSONICRCBL-L) is available for interfacing a WindSonic1 or WindSonic4 to a PC running the manufacturer's PC support software. The cable and software are used during troubleshooting or to change settings in the WindSonic1 for a specific application. A copy of this PC support software is available at www.gill.co.uk/main/software.html. WindView is used for WindSonic1s with serial numbers of 0810001 or greater, and WindCom is used for WindSonic1s with serial numbers that are less than 0810001.

6. Specifications

Features:

- Low maintenance—no moving parts significantly reduces maintenance cost and time
- Minimum detectable wind speed of 0.01 meters per second
- Compatible with Campbell Scientific CRBasic Dataloggers: CR200(X) series (WindSonic4 only), CR300 series, CR6 series, CR800 series, CR1000, CR3000, and CR5000 (WindSonic4 only)

6.1 Wind Direction

Operating Range:	0 to 359° (no dead band)
Accuracy:	±3°
Output Resolution:	1°

6.2 Wind Speed

Operating Range:	0 to 60 m s ⁻¹
Accuracy:	±2% @ 12 m s ⁻¹
Output Resolution:	0.01 m s ⁻¹

6.3 General Specifications

Output Signal:	RS-232 (WindSonic1) SDI-12 version 1.3 (WindSonic4); address factory set to 0
Output Variables:	wind direction, wind speed, and diagnostic or u_x , u_y , and diagnostic (WindSonic4 only)
Measurement Frequency:	40 Hz block averaged to a programmable output frequency, factory set to 1 Hz
Current Drain:	~15 mA continuous (WindSonic1) <12 mA @ 12 V (WindSonic4)
Operating Temperature:	-35 to 70 °C
Storage Temperature:	-40 to 80 °C
Dimensions:	142 x 160 mm (5.6 x 6.3 in)
Weight:	500 g (1.1 lb)
Operating Humidity:	<5% to 100% RH

6.4 Campbell Scientific Factory Default Settings for the WindSonic1

The default settings for the WindSonic1 were changed in February 2013 to improve operation in cold temperatures. Sensors with the newer settings have a white dot next to the connector on the underside of the sensor (see FIGURE 6-1). They also include both a yellow and a white heat shrink label on the cable; older sensors included two white heat shrink labels.

- Continuous polar wind (M2)
- Wind speed in m s^{-1} (U1)
- Field formatted, comma separated values (O1) [changed in February 2013]
- Terminate records with a carriage return and line feed (L1)
- 1 Hz output frequency (P1)
- Baud rate – 9600 baud (B3) [changed in February 2013]
- Power up message (H1) [changed in February 2013]
- Address set to “Q” (NQ)
- Data bits and parity — 8 bits, no parity (F1)
- RS-232 interface (E3)
- Analog output 0 to 5 Vdc (T1) — does not apply
- Analogy range 0 to 30 m s^{-1} (S4) — does not apply
- Analog wrap around 0 to 360 degrees (C2) — does not apply
- Minimum direction velocity (K50)

CAUTION

WindSonic1s with the newer default settings will not work with older programs or *Short Cut* 3.0 or older. Appendix D, *Updating an Older Program for Measuring a WindSonic1 with the New Settings* (p. D-1), provides information about updating an older program for a WindSonic1 with the newer settings.



FIGURE 6-1. White dot indicating that the WindSonic1 has the newer settings

7. Installation

If you are programming your datalogger with *Short Cut*, skip Section 7.3, *Wiring* (p. 11), and Section 7.4, *Datalogger Programming* (p. 13). *Short Cut* does this work for you. See Section 4, *QuickStart* (p. 2), for a *Short Cut* tutorial.

7.1 Siting

Locate the WindSonic away from obstructions such as trees and buildings. The distance between wind sensors and the nearest obstruction should be ten times the height of the obstruction. If it is necessary to mount the WindSonic on the roof of a building, the height of the sensor, above the roofline, should be at least 1.5 times the height of the building. See Section 10, *Siting References* (p. 18), for a list of references that discuss siting wind direction and speed sensors.

7.2 Mount the Sensor

The WindSonic is mounted using the components of the 17387 Mounting Pipe Kit, which is shipped with the WindSonic (see Section 3.1, *Ships With* (p. 2)).

1. Thread the connector end of the cable through the tubing; start at the end without the three threaded holes.
2. Attach the female mating connector on the cable to the male mating connector located on the bottom of the WindSonic.
3. Secure the WindSonic to the tubing using the three #6-32 x 0.375-inch pan head screws (pn 505).

4. Attach the tubing to a CM202, CM204, or CM206 crossarm via the CM220 Right Angle Mounting Kit (see FIGURE 7-1).
5. Mount the crossarm to the tripod or tower.
6. Orient the WindSonic so that the colored **North** marker arrows point to True North (see FIGURE 7-1). Appendix C, *WindSonic Orientation* (p. C-1), contains detailed information on determining True North using a compass and the magnetic declination for the site.



FIGURE 7-1. WindSonic mounted on a CM202 using pn 17837

7. Route the sensor cable along the underside of the crossarm to the tripod or tower, and to the instrument enclosure.
8. Secure the cable to the crossarm and tripod or tower using cable ties.

7.3 Wiring

7.3.1 Datalogger to WindSonic1 Wiring

The CR300-series, CR800-series, CR1000, and CR3000 dataloggers support serial communications with dedicated UART hardware on their control ports. They use two control ports configured as a single communications (COM n) port. The CR6 uses two control ports or two universal channels configured as a single communication port.

NOTE

The WindSonic1 can also be connected to the CR6's CPI/RS-232 port by using an RJ45 terminal block adapter (pn 31897). Information about using this adapter is provided in Appendix E, *Using the CR6 Datalogger's CPI/RS-232 Port* (p. E-1).

The WindSonic1 serial interface uses four wires as shown in TABLE 7-1.

TABLE 7-1. WindSonic1 to Datalogger Connections

Description	Color	CRBasic Datalogger
WindSonic RxD	Green	Tx (COMn, Cn, or Un)
WindSonic TxD	White	Rx (COMn, Cn, or Un)
Power	Red	12V
Serial/Power Reference	Black	G
Shield	Clear	G

NOTE The maximum cable length that can be used with a RS-232 interface depends on the baud rate, the nominal resistance of the wire, the capacitance between conductors, and the capacitance between the conductors and the shield. According to the Electronic Industries Association RS-232D standard, a rough rule of thumb is to limit RS-232 cable lengths to 15.24 m (50 ft) or less at 9600 bps.

7.3.2 SDM-SIO1 Wiring

The SDM-SIO1 can be used to increase the number of sensors that a CR800-series, CR1000, or CR3000 datalogger can measure. The SDM-SIO1 converts RS-232 signals into Synchronous Device for Measurements (SDM). SDM is a Campbell Scientific digital communications protocol used between Campbell Scientific dataloggers and SDM peripherals. At a 1 Hz measurement rate, a maximum of four WindSonic1 sensors can be measured by a datalogger. TABLE 7-2 describes the connections between a WindSonic1 and SDM-SIO1.

TABLE 7-2. WindSonic1 to SDM-SIO1 Connections

Description	Color	SDM-SIO1
WindSonic RxD	Green	TX-Z
WindSonic TxD	White	RX-A
Power	Red	+12V
Serial/Power Reference	Black	G
Shield	Clear	G

7.3.3 WindSonic4 Wiring

The WindSonic4 interfaces to a Campbell Scientific datalogger using SDI-12. SDI-12 is a three-wire interface used between processor-based sensors and digital recorders (TABLE 7-3). Each SDI-12 sensor has a unique address. The factory-set address for the WindSonic is 0. To change the SDI-12 address, see Section 8.2.1, *Changing the SDI-12 Address Using LoggerNet and a Datalogger* (p. 16). At a 1 Hz measurement rate, a maximum of four WindSonic4s can be measured by a datalogger.

TABLE 7-3. WindSonic4 to Datalogger Connections

Description	Color	Datalogger
SDI-12 Data	Green	SDI-12 Input or Control Port
SDI-12 Power	Red	12V
SDI-12 Reference	Black	G
Shield	Clear	G

7.4 Datalogger Programming

Short Cut is the best source for up-to-date datalogger programming code. Programming code is needed when:

- Creating a program for a new datalogger installation
- Adding sensors to an existing datalogger program

If your data acquisition requirements are simple, you can probably create and maintain a datalogger program exclusively with *Short Cut*. If your data acquisition needs are more complex, the files that *Short Cut* creates are a great source for programming code to start a new program or add to an existing custom program.

NOTE

Short Cut cannot edit programs after they are imported and edited in *CRBasic Editor*.

A *Short Cut* tutorial is available in Section 4, *QuickStart* (p. 2). If you wish to import *Short Cut* code into *CRBasic Editor* to create or add to a customized program, follow the procedure in Appendix A, *Importing Short Cut Code Into CRBasic Editor* (p. A-1).

Programming basics for CRBasic dataloggers are provided in the following sections. Complete program examples for select CRBasic dataloggers can be found in Appendix B, *Example Programs* (p. B-1). Programming basics and programming examples for Edlog dataloggers are provided at www.campbellsci.com/old-manuals.

7.4.1 WindSonic1 Programming

The WindSonic1 updates the RS-232 output to a user-set frequency. The CRBasic dataloggers use the **SerialInRecord()** instruction to retrieve the latest record sent by the WindSonic1 at the scan interval. This ensures that the most current wind data is available for use by the program.

The datalogger and WindSonic1 each use their own internal clocks. These clocks are not perfectly synchronized with each other and will drift in and out of phase. This phase drift could cause missed samples because no new data was transmitted to the datalogger in time for the next scan. The programs in this manual record the number of missed records as no new data (nnd_TOT). A no new data error will occur if the WindSonic1 is disconnected from the serial port, the WindSonic1 has no power, or the datalogger and WindSonic1 clocks have drifted out of phase by one cycle.

Early versions of the datalogger operating system (OS) did not support serial communication using control ports or the instruction **SerialInRecord()**. It may be necessary to update the datalogger OS. TABLE 7-4 lists the OS versions that support both serial communications using control ports and the **SerialInRecord()**. The most current datalogger operating systems are available on the Campbell Scientific website in the Support/Downloads section.

TABLE 7-4. CRBasic Datalogger Operating Systems that Support RS-232 Communications and SerialInRecord()	
Datalogger Model	Operating System
CR6 series	1.0 or later
CR800 series	4.0 or later
CR1000	13.0 or later
CR3000	6.0 or later

7.5 WindSonic4 Programming

The WindSonic4 updates the SDI-12 output at a frequency of 1 Hz. The **SDI12Recorder()** measurement instruction programs CRBasic dataloggers to measure the WindSonic4. This instruction sends a request to the sensor to make a measurement and then retrieves the measurement from the sensor. When using a CR200(X), the **SDI12Recorder()** instruction has the following structure:

SDI12Recorder(*Destination, OutString, Multiplier, Offset*)

For the other CRBasic dataloggers, the **SDI12Recorder()** instruction has the following syntax:

SDI12Recorder(*Destination, SDIPort, SDIAddress, "SDICommand", Multiplier, Offset*)

The *Destination* parameter needs to be a variable array with three elements. The most appropriate SDI-12 command to retrieve data from the WindSonic4 is the aRo!, where *a* is the WindSonic SDI-12 address and *o* is the data format option (TABLE 7-5).

TABLE 7-5. WindSonic4 Data Format Option			
Option (o)	Output	Units	Comment
0	wind direction	degrees	Compass polar coordinate system
	wind speed	m s ⁻¹	
	diagnostic	unitless	
1	u _x wind	m s ⁻¹	Orthogonal right hand coordinate system
	u _y wind	m s ⁻¹	
	diagnostic	unitless	

TABLE 7-6 lists the datalogger OS version and revision that supports the SDI-12 **aRo!** command. The most current datalogger operating systems are available at the Campbell Scientific website in the Support/Downloads section.

TABLE 7-6. Datalogger Operating Systems that Support the SDI-12 “aRo!” Command	
Datalogger Model	Operating System
CR6 series	1.0 or later
CR200(X) series	3.0a or later
CR800 series	1.0 or later
CR1000	1.0 or later
CR3000	1.0 or later
CR5000	1.8 or later

See Section 8.2, *SDI-12 Measurement Details* (p. 15), for more information about this instruction.

8. Operation

8.1 Sensor Configuration

To mimic a mechanical anemometer, the WindSonic’s output frequency must match the datalogger’s scan frequency. The factory setting for the WindSonic1 and WindSonic4 is 1 Hz; for example, 1 output per second. The data output frequency of the WindSonic4 cannot be changed.

The data output frequency of the WindSonic1 can be set to five discrete values (see TABLE 8-1) using Gill’s PC support software and the RS-232 WindSonic to PC cable.

TABLE 8-1. WindSonic1 Output Frequencies	
Output Frequency (Hz)	Seconds Per Output (s)
4	0.25
2	0.5
1	1
0.5	2
0.25	4

8.2 SDI-12 Measurement Details

CRBasic instruction **SDI12Recorder()** measures the WindSonic4 typically using the Continuous Measurement (**aR!**) command. When the datalogger issues the **aRo!** command, the WindSonic4 immediately begins transmitting

the most current wind measurements to the datalogger. After receiving the **aRo!** command, it takes the WindSonic4 approximately 190 milliseconds \pm 10 milliseconds to transmit the data.

The **aDo!** command can also be used, but it will take slightly longer to retrieve the data because of the additional handshaking required with the **aDo!** command.

For all practical purposes, a datalogger can measure up to 4 WindSonic4s at 1 Hz.

8.2.1 Changing the SDI-12 Address Using *LoggerNet* and a Datalogger

Up to ten WindSonic4s or other SDI-12 sensors can be connected to a single datalogger control port. A datalogger can measure up to 4 WindSonic4 at 1 Hz. Each SDI-12 device must have a unique SDI-12 address between 0 and 9. The factory-set SDI-12 address for the WindSonic4 is 0. The WindSonic4 SDI-12 address is changed in software by issuing the **aAb!** command, where *a* is the current address and *b* is the new address, to the WindSonic4 over the SDI-12 interface. The current address can be found by issuing the **?!** command.

A computer running *LoggerNet* can be used to issue any valid SDI-12 command through the datalogger to the WindSonic4. For a complete list of SDI-12 commands supported by the WindSonic4, see Section 11 of the Gill WindSonic manual.

8.2.1.1 CR200(X)-Series Datalogger

- Connect a single WindSonic4 to the datalogger using Control Port C1/SDI12 as described in Section 7.3.3, *WindSonic4 Wiring (p. 12)*, and download a datalogger program that does not contain the **SDI12Recorder()** instruction.
- In the *LoggerNet* Toolbar, navigate to and activate the Test|Terminal Emulator ... menu. The Terminal Emulator window will open. In the Select Device menu, located in the lower left hand side of the window, select the station.
- Click on the **Open Terminal** button. If communications between the datalogger and PC are successful, the red bar located in the upper left hand side of the window will turn green.
- Press the **Enter** key until the datalogger responds with the “CR200(X)>” prompt (FIGURE 8-1).
- To query the WindSonic4 for its current SDI-12 address, press the **Enter** key, at the “CR200(X)>” prompt enter the command “SDI12>?!”, and press the **Enter** key. The WindSonic4 will respond with the current SDI-12 address.
- To change the SDI-12 address, press the **Enter** key, at the “CR200(X)>” prompt enter the command “SDI12>aAb!”; where *a* is the current address from the above step and *b* is the new address. The WindSonic4 will change its address and the datalogger will exit the SDI-12 Transparent Mode and respond with “Fail”.

- Verify the new SDI-12 address. Press the **Enter** key, at the “CR200(X)>” prompt enter the command “SDI12>?!” and press the **Enter** key. The WindSonic4 will respond with the new address.

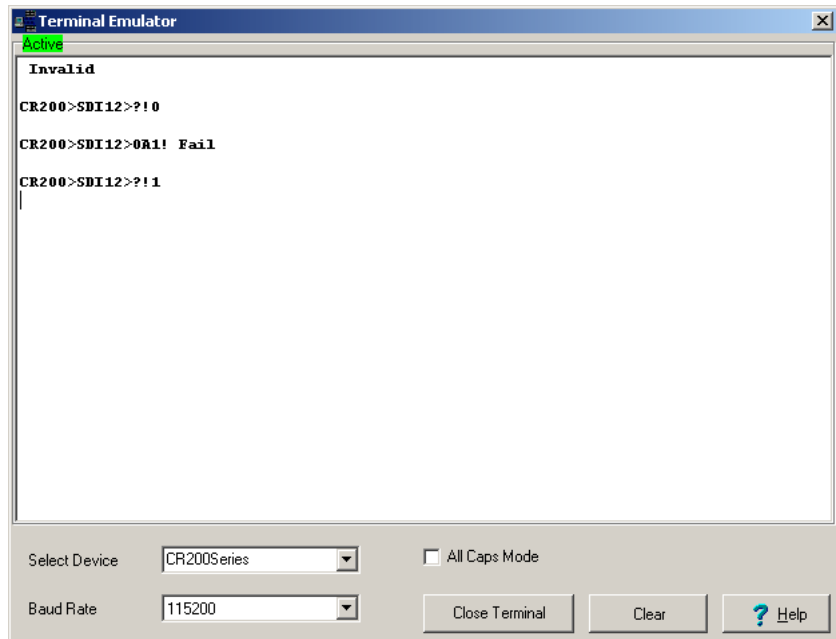

FIGURE 8-1. SDI-12 Transparent Mode for a CR200(X) used to change the SDI-12 address from 0 to 1

9. Maintenance and Troubleshooting

9.1 Troubleshooting

The WindSonic outputs a diagnostic (TABLE 9-1) along with each wind direction and speed measurement. The example datalogger programs in this manual filter all data when the diagnostic is not 0. Short generated programs do not filter data based on the WindSonic diagnostic. Both the example programs in this manual and those generated in SCWin record the number of times an error flag was set. If the WindSonic is not powered, not connected, is using the wrong COM port/SDI-12 address, or has missed a sample, the example programs in this manual will load NaN or -99999 for wind direction and speed, and the diagnostic (TABLE 9-2). The programs also report the number of good samples that were used in computing the online statistics. If the total number of good samples is less than 98% of the expected samples, the WindSonic may be in need of repair.

TABLE 9-1. Gill WindSonic Diagnostic Codes

Diagnostic	Status	Comment
0	Okay	All okay
1	Axis 1 Failed	Insufficient samples, possible path obstruction
2	Axis 2 Failed	Insufficient samples, possible path obstruction
4	Both Axis Failed	Insufficient samples, possible path obstruction
8	NVM error	Nonvolatile Memory checksum failed
9	ROM error	Read Only Memory checksum failed
10	Maximum Gain	Questionable wind measurements

TABLE 9-2. Example Datalogger Program Diagnostic Codes

Diagnostic	Comment
NaN	WindSonic not powered, not connected, wrong COM port/SDI-12 address, or missed sample

9.2 Maintenance

There are no user-serviceable parts on the WindSonic. Keep the transducer paths clear of any obstructions. When clearing the transducer paths, do not remove or damage the transducer matching layer. The transducers can be gently cleaned with a cloth and mild detergent. Do not use solvents and avoid scratching or damaging the matching layers. The transducer’s matching layers are the “rubber” caps on each of the transducers. Should the WindSonic be damaged, fail to output data, or send a nonzero diagnostic, return it for repair (refer to the [Assistance](#) section at the beginning of this manual for the process of returning a product to Campbell Scientific). For more information, see Section 12, *Maintenance and Fault-Finding*, in the manual published by Gill Instruments.

10. Siting References

The following references give detailed information on siting wind direction and wind speed sensors.

EPA, 1987: *On-Site Meteorological Program Guidance for Regulatory Modeling Applications*, EPA-450/4-87-013, Office of Air Quality Planning and Standards, Research Triangle Park, NC, 27711.

EPA, 1989: *Quality Assurance Handbook for Air Pollution Measurements System*, Office of Research and Development, Research Triangle Park, NC, 27711.

The State Climatologist, 1985: *Publication of the American Association of State Climatologists: Height and Exposure Standards, for Sensors on Automated Weather Stations*, vol. 9, No. 4.

WMO, 1983: *Guide to Meteorological Instruments and Methods of Observation*, World Meteorological Organization, No. 8, 5th edition, Geneva, Switzerland.

Appendix A. Importing Short Cut Code Into CRBasic Editor

This tutorial shows:

- How to import a *Short Cut* program into a program editor for additional refinement
- How to import a wiring diagram from *Short Cut* into the comments of a custom program

Short Cut creates files, which can be imported into *CRBasic Editor*. Assuming defaults were used when *Short Cut* was installed, these files reside in the C:\campbellsci\SCWin folder:

- .DEF (wiring and memory usage information)
- .CR2 (CR200(X)-series datalogger code)
- .CR300 (CR300-series datalogger code)
- .CR6 (CR6-series datalogger code)
- .CR8 (CR800-series datalogger code)
- .CR1 (CR1000 datalogger code)
- .CR3 (CR3000 datalogger code)
- .CR5 (CR5000 datalogger code)

Use the following procedure to import *Short Cut* code and wiring diagram into *CRBasic Editor*.

1. Create the *Short Cut* program following the procedure in Section 4, *QuickStart* (p. 2). Finish the program and exit *Short Cut*. Make note of the file name used when saving the *Short Cut* program.
2. Open *CRBasic Editor*.
3. Click **File | Open**. Assuming the default paths were used when *Short Cut* was installed, navigate to C:\CampbellSci\SCWin folder. The file of interest has the .CR2, .CR300, .CR6, .CR8, .CR1, .CR3, or .CR5 extension. Select the file and click **Open**.
4. Immediately save the file in a folder different from C:\Campbellsci\SCWin, or save the file with a different file name.

NOTE

Once the file is edited with *CRBasic Editor*, *Short Cut* can no longer be used to edit the datalogger program. Change the name of the program file or move it, or *Short Cut* may overwrite it next time it is used.

5. The program can now be edited, saved, and sent to the datalogger.
6. Import wiring information to the program by opening the associated .DEF file. Copy and paste the section beginning with heading “-Wiring for CRXXX-” into the CRBasic program, usually at the head of the file. After pasting, edit the information such that an apostrophe (') begins each line. This character instructs the datalogger compiler to ignore the line when compiling.

Appendix B. Example Programs

B.1 WindSonic1 Programs

B.1.1 CR1000 WindSonic1 Program Using COMn Port

TABLE B-1. Wiring for CR1000 Example Program

Description	Color	CR1000
WindSonic RxD	Green	COM1 Tx (C1)
WindSonic TxD	White	COM1 Rx (C2)
Power	Red	+12 Vdc
RS-232/Power Reference	Black	G
Shield	Clear	G

CRBasic Example B-1. CR1000 WindSonic1 Program Using COMn Port

```
'CR1000 Series Datalogger
Dim in_bytes_str As String * 21
Dim windsonic(4) As String
Public nmr_bytes_rtrnd
Public wind_direction
Public wind_speed
Public diag
Units wind_direction = degrees
Units wind_speed = m/s
Units diag = unitless
Dim checksum_flg As Boolean
Dim disable_flg As Boolean
Dim n
Units n = arb
DataTable (stats,TRUE,-1)
  DataInterval (0,30,Min,10)
  WindVector (1,wind_speed,wind_direction,IEEE4,disable_flg,0,0,0)
  FieldNames ("mean_wind_speed,mean_wind_direction,std_wind_dir")
  Totalize (1,n,IEEE4,disable_flg)
  FieldNames ("samples_TOT")
  Totalize (1,n,IEEE4,diag<>1)
  FieldNames ("diag_1_TOT")
  Totalize (1,n,IEEE4,diag<>2)
  FieldNames ("diag_2_TOT")
  Totalize (1,n,IEEE4,diag<>4)
  FieldNames ("diag_4_TOT")
  Totalize (1,n,IEEE4,diag<>8)
  FieldNames ("diag_8_TOT")
  Totalize (1,n,IEEE4,diag<>9)
  FieldNames ("diag_9_TOT")
  Totalize (1,n,IEEE4,diag<>10)
  FieldNames ("diag_10_TOT")
  Totalize (1,n,IEEE4,nmr_bytes_rtrnd<>0)
  FieldNames ("nnd_TOT")
  Totalize (1,n,IEEE4,nmr_bytes_rtrnd<>0 IMP checksum_flg)
  FieldNames ("checksum_err_TOT")
EndTable
```

```

BeginProg
n = 1
SerialOpen (Com1,9600,3,0,108)
Scan (1,Sec,3,0)
  'Get data from WindSonic.
  SerialInRecord (Com1,in_bytes_str,&h02,0,&h0D0A,nmbr_bytes_rtrnd,01)
  SplitStr (windsonic(),in_bytes_str,",",4,4) 'Split the string and convert to floats.
  wind_direction = windsonic(1)
  wind_speed = windsonic(2)
  diag = windsonic(4)
  checksum_flg = ( HexToDec (Right (in_bytes_str,2))) EQV (Checksum (in_bytes_str,9,Len (in_bytes_str)-3)) )
  disable_flg = ( NOT (checksum_flg) OR (nmbr_bytes_rtrnd=0) OR (diag<>0) )
  CallTable stats
NextScan
EndProg
    
```

B.1.1 CR1000 WindSonic1 Program Using SDM-SIO1

TABLE B-2. Wiring for CR1000/SDM-SIO1 Program Example

Description	Color	CR1000
WindSonic RxD	Green	TX-Z
WindSonic TxD	White	RX-A
Power	Red	+12 Vdc
RS-232/Power Reference	Black	G
Shield	Clear	G

CRBasic Example B-2. CR1000 WindSonic1 Program Using SDM-SIO1

```

'CR1000 Series Datalogger
Dim in_bytes_str As String * 21
Dim windsonic(4) As String
Public nmbr_bytes_rtrnd
Public wind_direction
Public wind_speed
Public diag
Units wind_direction = degrees
Units wind_speed = m/s
Units diag = unitless
Dim checksum_flg As Boolean
Dim disable_flg As Boolean
Dim n
Units n = arb
DataTable (stats,TRUE,-1)
  DataInterval (0,30,Min,10)
  WindVector (1,wind_speed,wind_direction,IIEEE4,disable_flg,0,0,0)
  FieldNames ("mean_wind_speed,mean_wind_direction,std_wind_dir")
  Totalize (1,n,IIEEE4,disable_flg)
  FieldNames ("samples_TOT")
  Totalize (1,n,IIEEE4,diag<>1)
  FieldNames ("diag_1_TOT")
  Totalize (1,n,IIEEE4,diag<>2)
  FieldNames ("diag_2_TOT")
  Totalize (1,n,IIEEE4,diag<>4)
  FieldNames ("diag_4_TOT")
  Totalize (1,n,IIEEE4,diag<>8)
  FieldNames ("diag_8_TOT")
    
```

```

Totalize (1,n,IEEE4,diag<>9)
FieldNames ("diag_9_TOT")
Totalize (1,n,IEEE4,diag<>10)
FieldNames ("diag_10_TOT")
Totalize (1,n,IEEE4,nmbr_bytes_rtrnd<>0)
FieldNames ("nnd_TOT")
Totalize (1,n,IEEE4,nmbr_bytes_rtrnd<>0 IMP checksum_flg)
FieldNames ("checksum_err_TOT")
EndTable
BeginProg
n = 1
SerialOpen (40,9600,3,0,108) 'SDM-SI01 SDM address set To 8.
Scan (1,Sec,3,0)
  'Get data from WindSonic.
  SerialInRecord (40,in_bytes_str,&h02,0,&h0D0A,nmbr_bytes_rtrnd,01)
  SplitStr (windsonic(),in_bytes_str,",",4,4) 'Split the string and convert to floats.
  wind_direction = windsonic(1)
  wind_speed = windsonic(2)
  diag = windsonic(4)
  checksum_flg = ( HexToDec (Right (in_bytes_str,2))) EQV (Checksum (in_bytes_str,9,Len (in_bytes_str)-3)) )
  disable_flg = ( NOT (checksum_flg) OR (nmbr_bytes_rtrnd=0) OR (diag<>0) )
  CallTable stats
NextScan
EndProg

```

B.2 WindSonic4 Programs

B.2.1 CR200X WindSonic4 Program

TABLE B-3. Wiring for CR200(X) Program Example

Description	Color	CR200(X)
SDI-12 Data	Green	C1/SDI-12
SDI-12 Power	Red	+12 Vdc
SDI-12 Reference	Black	G
Shield	Clear	G

CRBasic Example B-3. CR200X WindSonic4 Program

```

'CR200(X) Series DataLogger

Public windsonic(3)
Alias windsonic(1) = wind_direction
Alias windsonic(2) = wind_speed
Alias windsonic(3) = diag
Units wind_direction = degrees
Units wind_speed = m/s
Units diag = unitless

Dim disable_flg
Dim one
Units one = samples

DataTable (stats,TRUE,-1)
  DataInterval (0,30,Min)

WindVector (wind_speed,wind_direction,disable_flg,0,0)
FieldNames ("mean_wnd_spd,mean_wnd_dir,std_wnd_dir")

```

```

Totalize (1,one,disable_flag)
FieldNames ("n_TOT")
Totalize (1,one,diag<>1)
FieldNames ("diag_1_TOT")
Totalize (1,one,diag<>2)
FieldNames ("diag_2_TOT")
Totalize (1,one,diag<>4)
FieldNames ("diag_4_TOT")
Totalize (1,one,diag<>8)
FieldNames ("diag_8_TOT")
Totalize (1,one,diag<>9)
FieldNames ("diag_9_TOT")
Totalize (1,one,diag<>10)
FieldNames ("diag_10_TOT")
Totalize (1,one,diag<>NaN)
FieldNames ("no_data_TOT")
EndTable

BeginProg
one = 1
Scan (1,Sec)
  SDI12Recorder (wind_direction,OR0!,1,0)
  IF (wind_direction = NAN ) Then
    wind_speed = NAN
    diag = NAN
  EndIf
  disable_flag = (wind_direction=NAN) OR (diag<>0)

  CallTable stats
NextScan
EndProg

```

B.2.2 CR800 WindSonic4 Program

TABLE B-4. Wiring for CR800 Program Example

Description	Color	CR800
SDI-12 data	Green	C1
SDI-12 power	Red	+12 Vdc
SDI-12 reference	Black	G
shield	Clear	G

CRBasic Example B-4. CR800 WindSonic4 Program

```

'CR800 Series DataLogger

Public windsonic(3)
Alias windsonic(1) = wind_direction
Alias windsonic(2) = wind_speed
Alias windsonic(3) = diag
Units wind_direction = degrees
Units wind_speed = m/s
Units diag = unitless

Dim disable_flag AS Boolean
Dim one
Units one = samples

DataTable (stats,TRUE,-1)

```

```

DataInterval (0,30,Min,10)

WindVector (1,wind_speed,wind_direction,IEEE4,disable_flag,0,0,0)
FieldNames ("mean_wind_speed,mean_wind_direction,std_wind_dir")
Totalize (1,one,IEEE4,disable_flag)
FieldNames ("n_TOT")
Totalize (1,one,IEEE4,diag<>1)
FieldNames ("diag_1_TOT")
Totalize (1,one,IEEE4,diag<>2)
FieldNames ("diag_2_TOT")
Totalize (1,one,IEEE4,diag<>4)
FieldNames ("diag_4_TOT")
Totalize (1,one,IEEE4,diag<>8)
FieldNames ("diag_8_TOT")
Totalize (1,one,IEEE4,diag<>9)
FieldNames ("diag_9_TOT")
Totalize (1,one,IEEE4,diag<>10)
FieldNames ("diag_10_TOT")
Totalize (1,one,IEEE4,diag<>NAN)
FieldNames ("nnd_TOT")
EndTable

BeginProg
one = 1
Scan (1,Sec,3,0)
  SDI12Recorder (wind_direction,1,0,"R0!",1,0)
  If ( wind_direction = NAN ) Then
    wind_speed = NAN
    diag = NAN
  EndIf
  disable_flag = (wind_direction=NAN) OR (diag<>0)

  CallTable stats
NextScan
EndProg

```

Appendix C. WindSonic Orientation

C.1 Determining True North and Sensor Orientation

The orientation of the WindSonic “North Arrow Markers” is found by reading a magnetic compass and applying the site-specific correction for magnetic declination; where the magnetic declination is the number of degrees between True North and Magnetic North. Magnetic declination for a specific site can be obtained from a USGS map, local airport, or through a NOAA web calculator (Appendix C.2, *Online Magnetic Declination Calculator* (p. c-3)). A general map showing magnetic declination for the Conterminous United States is shown in FIGURE C-1.

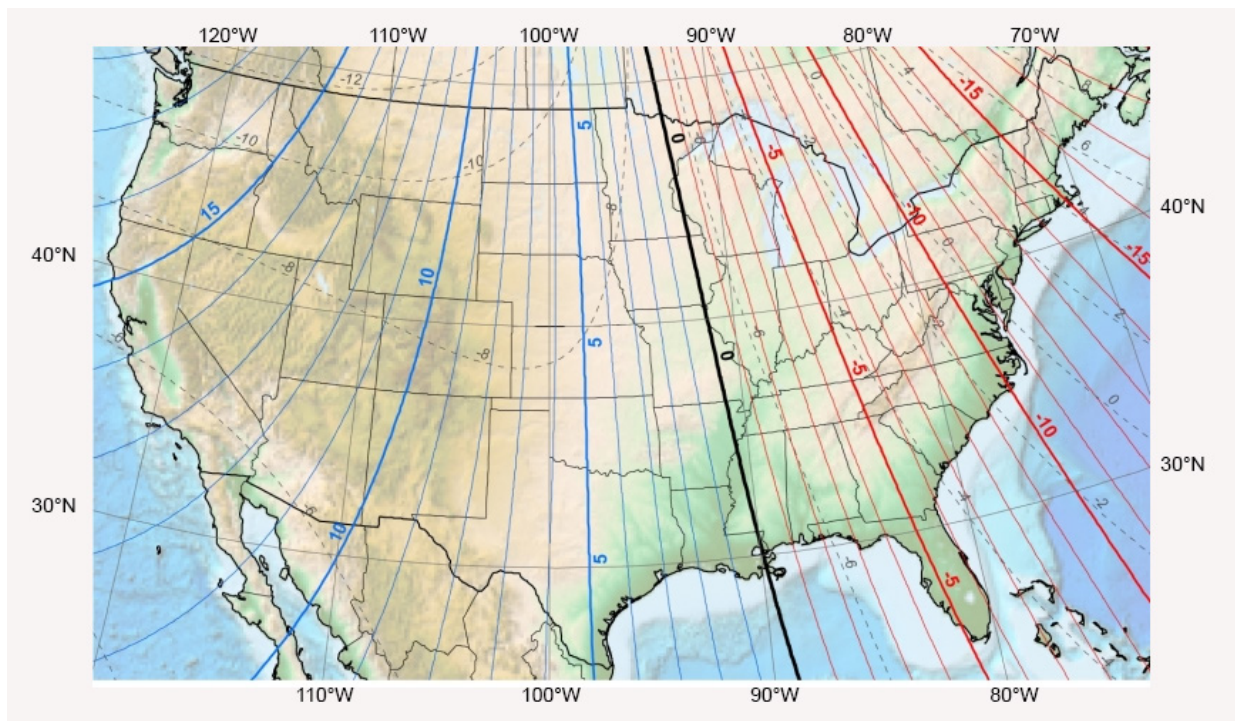

FIGURE C-1. Magnetic declination for the conterminous United States (2015)

Declination angles east of True North are considered negative, and are subtracted from 360 degrees to get True North as shown FIGURE C-2 (0° and 360° are the same point on a compass). Declination angles west of True North are considered positive, and are added to 0 degrees to get True North as shown in FIGURE C-3.

For example, the declination for Longmont, CO (10 June 2006) is 9.67° , thus True North is $360^\circ - 9.67^\circ$, or 350.33° as read on a compass. Likewise, the declination for McHenry, IL (10 June 2006) is -2.68° , and True North is $0^\circ - (-2.68^\circ)$, or 2.68° as read on a compass.

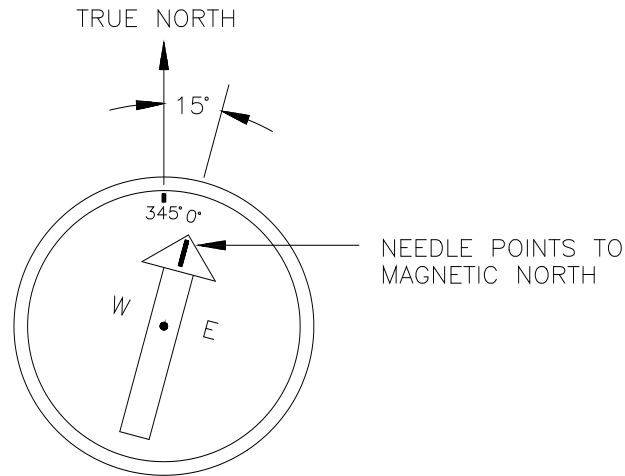

FIGURE C-2. A declination angle east of True North (positive) is subtracted from 360 (0) degrees to find True North

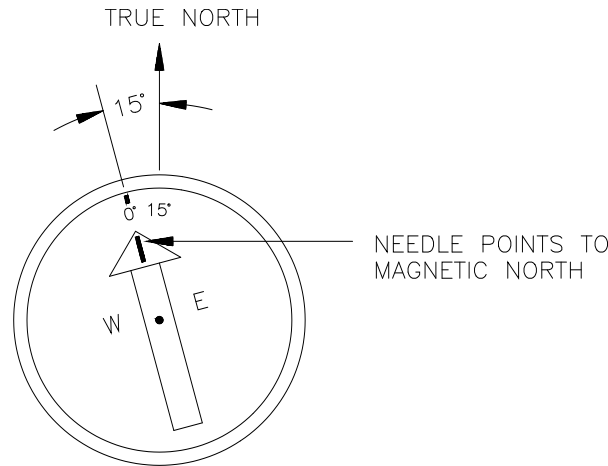

FIGURE C-3. A declination angle west of True North (negative) is subtracted from 0 (360) degrees to find True North

C.2 Online Magnetic Declination Calculator

The magnetic declination calculator web calculator published by NOAA's Geophysical Data Center is available at www.ngdc.noaa.gov/geomag-web. This web page calculates declination based on the latitude and longitude. You can look up your site's latitude and longitude by entering the **Zip Code** or the **Country** and **City**, and then clicking the **Get & Add Lat/Lon** button (FIGURE C-4). Click the **Calculate** button to get the magnetic declination.

NOAA NATIONAL CENTERS FOR ENVIRONMENTAL INFORMATION
NATIONAL OCEANIC AND ATMOSPHERIC ADMINISTRATION

NOAA > NESDIS > NCEI (formerly NGDC) > Geomagnetism

Magnetic Field Calculators

Declination | U.S. Historic Declination | Magnetic Field | Magnetic Field Component Grid

Magnetic Declination Estimated Value [?](#)

Declination is calculated using the most recent [World Magnetic Model \(WMM\)](#) or the [International Geomagnetic Reference Field \(IGRF\)](#) model. For 1590 to 1900 the calculator is based on the [gufm1](#) model. A smooth transition from gufm1 to IGRF was imposed from 1890 to 1900. Declination results are typically accurate to 30 minutes of arc, but environmental factors can cause magnetic field disturbances.

Calculate Declination

Latitude: S N

Longitude: W E

Model: WMM (2014-2019) IGRF (1590-2019)

Date: Year Month Day

Result format: HTML XML CSV PDF

Lookup Latitude / Longitude

Either enter a zip code, select a country/city, or search for an address at [USGS Earth Explorer](#).

U.S. Zip Code:

- OR -

Country:

City:

FIGURE C-4. NOAA web calculator

FIGURE C-5 shows that the calculated declination for Logan, UT is 11.78 degrees (11 August 2015). The declination for Utah is positive (east of north), so True North for this site is $360 - 11.78$, or 348.22 degrees. The annual change is 6 minutes west per year.

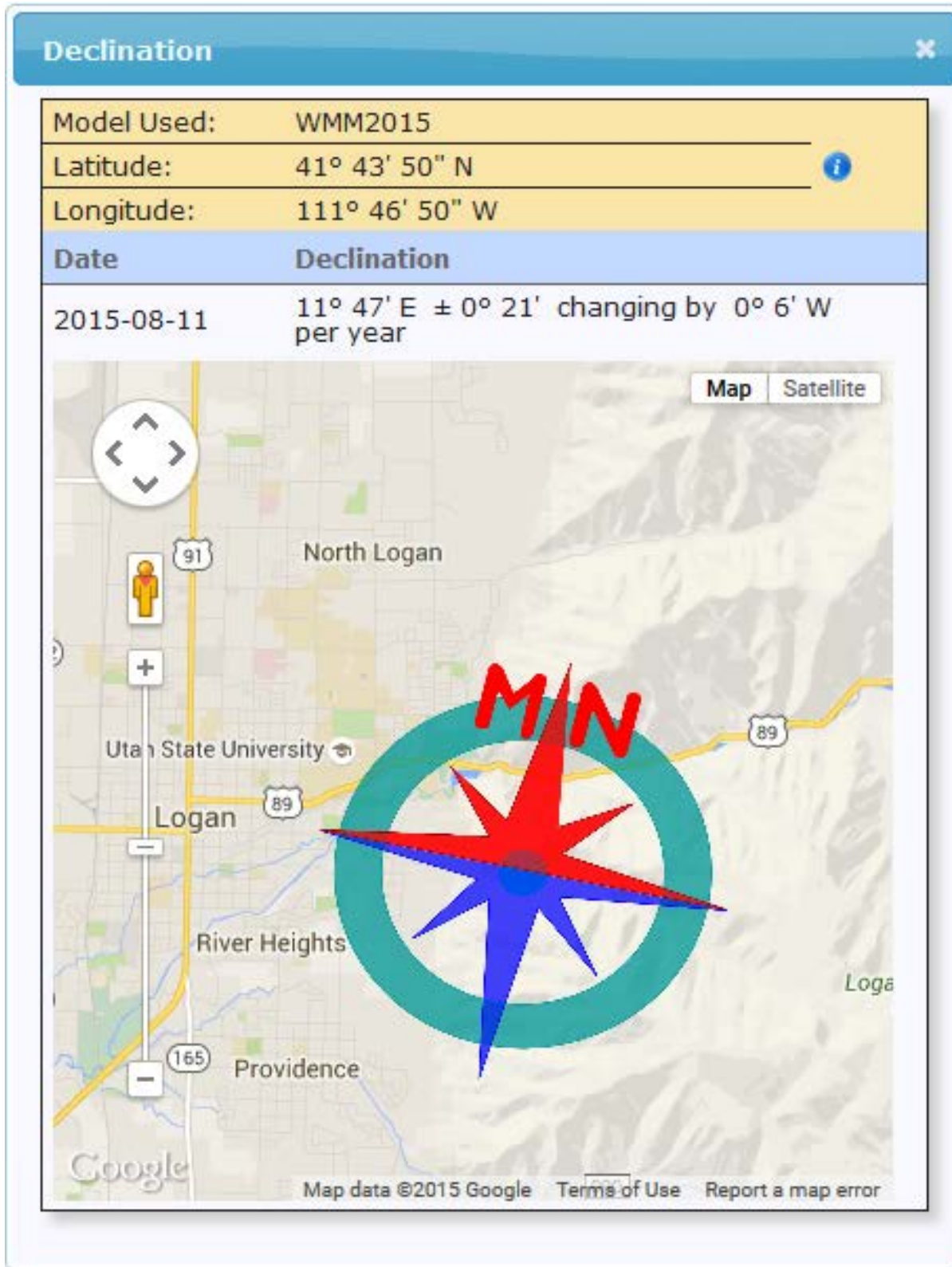

FIGURE C-5. NOAA calculated declination using HTML result format

Appendix D. Updating an Older Program for Measuring a WindSonic1 with the New Settings

In February 2013, the settings of the WindSonic1 sensor were changed to improve operation in cold temperatures. The communication baud rate has been changed from 38,400 to 9600 bps, and the data output structure has been changed to the manufacturer's default. Section 6.4, *Campbell Scientific Factory Default Settings for the WindSonic1* (p. 9), lists the newer default settings.

Sensors with the new settings can be identified by a small white painted dot next to the connector on the underside of the sensor. New sensor cables include both a yellow and white heat shrink label; older sensor cables had two white heat shrink labels. Because cables are interchangeable between new and old sensors, the best check is to look for the painted dot.

CAUTION

Sensors with newer settings will NOT work with older programs written for sensors set to 38,400 baud or *Short Cut* version 3.0 or older.

Older WindSonic1 programs can be changed by using CRBasic Editor or by cutting and pasting relevant sections from the updated manual. For additional support, contact Campbell Scientific at (435) 227-9000 or email support@campbellsci.com.

Programming examples shown below come from the old and new WindSonic manuals. Programs are not complete, but show the relevant sections to be changed.

Old CR1000 Program (Section 6.1 of 7/10 WindSonic manual)

(Public variables change. Data table structure stays the same.)

```
Public windsonic(4)
Alias windsonic(1) = wind_direction
Alias windsonic(2) = wind_speed
Alias windsonic(3) = diag
Alias windsonic(4) = nmb_rbytes_rtrnd
Units wind_direction = degrees
Units wind_speed = m/s
Units diag = unitless
Dim in_bytes_str As String * 21
Dim checksum_flg As Boolean
Dim disable_flg As Boolean
Dim n
Units n = arb
BeginProg
  n = 1
  SerialOpen (Com1,38400,3,0,49)
  Scan (1,Sec,3,0)
  SerialInRecord (Com1,in_bytes_str,&h02,0,&h0D0A,nmb_rbytes_rtrnd,00)
  wind_direction = Mid (in_bytes_str,3,3)
  wind_speed = Mid (in_bytes_str,7,6)
  diag = Mid (in_bytes_str,16,2)
  checksum_flg = ( HexToDec (Mid (in_bytes_str,20,2))) EQV (Checksum(in_bytes_str,9,18)) )
  disable_flg = (NOT (checksum_flg) OR (nmb_rbytes_rtrnd=0) OR (diag<>0))
```

New CR1000 Program (Appendix B.1.1)

(Public variables change. Data table structure stays the same.)

```
Dim windsonic(4) As String
Public wind_direction
Public wind_speed
Public diag
Public nmbr_bytes_rtrnd
Units wind_direction = degrees
Units wind_speed = m/s
Units diag = unitless
Dim in_bytes_str As String * 21
Dim checksum_flg As Boolean
Dim disable_flg As Boolean
Dim n
Units n = arb
BeginProg
  n = 1
  SerialOpen (Com1,9600,3,0,105)
  Scan (1,Sec,3,0)
  'Get data from WindSonic.
  SerialInRecord (Com1,in_bytes_str,&h02,0,&h0D0A,nmbr_bytes_rtrnd,01)
  SplitStr (windsonic(),in_bytes_str,",",4,4) 'Split the string and convert to floats.
  wind_direction = windsonic(1)
  wind_speed = windsonic(2)
  diag = windsonic(4)
  checksum_flg = ( HexToDec (Right (in_bytes_str,2))) EQV (Checksum (in_bytes_str,9,Len (in_bytes_str)-3)) )
  disable_flg = ( NOT (checksum_flg) OR (nmbr_bytes_rtrnd=0) OR(diag<>0) )
```

Old CR1000 SDM-SIO1 Program (Section 6.2 of 7/10 WindSonic manual)

(Public variables change. Data table structure stays the same.)

```
Public windsonic(4)
Alias windsonic(1) = wind_direction
Alias windsonic(2) = wind_speed
Alias windsonic(3) = diag
Alias windsonic(4) = nmbr_bytes_rtrnd
Units wind_direction = degrees
Units wind_speed = m/s
Units diag = unitless
Dim in_bytes_str As String * 21
Dim checksum_flg As Boolean
Dim disable_flg As Boolean
Dim n
Units n = arb
BeginProg
  n = 1
  SerialOpen (40,38400,3,0,49) 'SDM-SIO1 SDM address set to 8.
  Scan (1,Sec,3,0)
  'Get data from WindSonic.
  SerialInRecord (40,in_bytes_str,&h02,0,&h0D0A,nmbr_bytes_rtrnd,00)
  wind_direction = Mid (in_bytes_str,3,3)
  wind_speed = Mid (in_bytes_str,7,6)
  diag = Mid (in_bytes_str,16,2)
  checksum_flg = ( HexToDec (Mid (in_bytes_str,20,2))) EQV (Checksum(in_bytes_str,9,18)) )
  disable_flg = (NOT (checksum_flg) OR (nmbr_bytes_rtrnd=0) OR (diag<>0))
```

New CR1000 SDM-SIO1 Program (from Appendix B.1.2)

(Public variables change. Data table structure stays the same.)

```
Dim windsonic(4) As String
Public wind_direction
Public wind_speed
Public diag
Public nmb_bytes_rtrnd
Units wind_direction = degrees
Units wind_speed = m/s
Units diag = unitless
Dim in_bytes_str As String * 21
Dim checksum_flg As Boolean
Dim disable_flg As Boolean
Dim n
Units n = arb
BeginProg
  n = 1
  SerialOpen (40,9600,3,0,105) 'SDM-SIO1 SDM address set To 8.
  Scan (1,Sec,3,0)
  'Get data from WindSonic.
  SerialInRecord (40,in_bytes_str,&h02,0,&h0D0A,nmb_bytes_rtrnd,01)
  SplitStr (windsonic(),in_bytes_str,",",4,4) 'Split the string and convert to floats.
  wind_direction = windsonic(1)
  wind_speed = windsonic(2)
  diag = windsonic(4)
  checksum_flg = ( HexToDec (Right (in_bytes_str,2))) EQV (Checksum(in_bytes_str,9,Len (in_bytes_str)-3)) )
  disable_flg = ( NOT (checksum_flg) OR (nmb_bytertrnd=0) OR (diag<>0) )
```

Appendix E. Using the CR6 Datalogger's CPI/RS-232 Port

An RJ45 terminal block adapter (pn 31897) allows the WindSonic1 to be connected to the CPI/RS-232 port on the CR6. The CPI/RS-232 port is typically only used if the control ports or universal channels are not available. TABLE E-1 provides information about connecting the WindSonic1 to the adapter and CR6.

TABLE E-1. CPI/RS-232 Connections		
WindSonic1 Wire Color	RJ45 Terminal Block Connections	CR6 Connection
Green (RXD)	PIN 1 TXD	
White (TXD)	PIN 2 RXD	
Red (12 to 24 Vdc)		12V
Black (Power Ground)		G
Clear (Shield – Ground)		G
	RJ45 Connector	CPI/RS-232 Port

CRBasic Example E-1. Program for Using the CPI/RS-232 Port

```
'CR6 Series Datalogger
'WindSonic1 Wiring
'RED: CR6 12V
'GREEN: PIN 1 (RJ45 TERMINAL ADAPTER)
'WHITE: PIN 2 (RJ45 TERMINAL ADAPTER)
'BLACK: CR6 G
'CLEAR: CR6 G

Public PTemp, batt_volt

'Gill Sonic RS232 variables
Public Windsonic(4) As String
Public Wind_Dir : Units Wind_Dir = Deg
Public WS_ms : Units WS_ms = m/s
Public diag : Units diag = unitless
Public WindSpd_mph : Units WindSpd_mph = mph
Public nibr_bytes_rtrnd

Dim in_bytes_str As String * 21
Dim disable_flag As Boolean
Dim checksum_flg As Boolean
Dim one = {1}

'Define Data Tables.
DataTable (Test,1,9999) 'Set table size to # of records, or -1 to autoallocate.
  DataInterval (0,15,Sec,10)
  Minimum (1,batt_volt,FP2,0,False)
  Sample (1,PTemp,FP2)
EndTable

'Main Program
```

```
BeginProg
SerialOpen (ComRS232,9600,3,0,432)
Scan (3,Sec,0,0)
  PanelTemp (PTemp,15000)
  Battery (Batt_volt)

  'Gill WindSonic1 2-D Sonic
  SerialInRecord (ComRS232,in_bytes_str,&h02,0,&h0d0a,nmbr_bytes_rtrnd,01)
  SplitStr (Windsonic(),in_bytes_str,"",4,4)
  Wind_Dir = Windsonic(1)
  WS_ms = Windsonic(2)
  diag = Windsonic(4)
  checksum_flg = ( HexToDec (Right (in_bytes_str,2)) EQV (Checksum (in_bytes_str,9,Len (in_bytes_str)-3)) )
  disable_flg = ( NOT (checksum_flg) OR (nmbr_bytes_rtrnd=0) OR (diag<>0) )
  WindSpd_mph = WS_ms * 2.236936

  'Enter other measurement instructions
  'Call Output Tables
  'Example:
  CallTable Test
NextScan
EndProg
```

Campbell Scientific Companies

Campbell Scientific, Inc.

815 West 1800 North
Logan, Utah 84321
UNITED STATES

www.campbellsci.com • info@campbellsci.com

Campbell Scientific Canada Corp.

14532 – 131 Avenue NW
Edmonton AB T5L 4X4
CANADA

www.campbellsci.ca • dataloggers@campbellsci.ca

Campbell Scientific Africa Pty. Ltd.

PO Box 2450
Somerset West 7129
SOUTH AFRICA

www.campbellsci.co.za • cleroux@csafrica.co.za

Campbell Scientific Centro Caribe S.A.

300 N Cementerio, Edificio Breller
Santo Domingo, Heredia 40305
COSTA RICA

www.campbellsci.cc • info@campbellsci.cc

Campbell Scientific Southeast Asia Co., Ltd.

877/22 Nirvana@Work, Rama 9 Road
Suan Luang Subdistrict, Suan Luang District
Bangkok 10250
THAILAND

www.campbellsci.asia • info@campbellsci.asia

Campbell Scientific Ltd.

Campbell Park
80 Hathern Road
Shephed, Loughborough LE12 9GX
UNITED KINGDOM

www.campbellsci.co.uk • sales@campbellsci.co.uk

Campbell Scientific Australia Pty. Ltd.

PO Box 8108
Garbutt Post Shop QLD 4814
AUSTRALIA

www.campbellsci.com.au • info@campbellsci.com.au

Campbell Scientific Ltd.

3 Avenue de la Division Leclerc
92160 ANTONY
FRANCE

www.campbellsci.fr • info@campbellsci.fr

Campbell Scientific (Beijing) Co., Ltd.

8B16, Floor 8 Tower B, Hanwei Plaza
7 Guanghua Road
Chaoyang, Beijing 100004
P.R. CHINA

www.campbellsci.com • info@campbellsci.com.cn

Campbell Scientific Ltd.

Fahrenheitstraße 13
28359 Bremen
GERMANY

www.campbellsci.de • info@campbellsci.de

Campbell Scientific do Brasil Ltda.

Rua Apinagés, nbr. 2018 – Perdizes
CEP: 01258-00 – São Paulo – SP
BRASIL

www.campbellsci.com.br • vendas@campbellsci.com.br

Campbell Scientific Spain, S. L.

Avda. Pompeu Fabra 7-9, local 1
08024 Barcelona
SPAIN

www.campbellsci.es • info@campbellsci.es

Please visit www.campbellsci.com to obtain contact information for your local US or international representative.