

TDR200

TDR200-Based Time-Domain Reflectometry System



Limited Warranty

“Products manufactured by CSI are warranted by CSI to be free from defects in materials and workmanship under normal use and service for twelve months from the date of shipment unless otherwise specified in the corresponding product manual. (Product manuals are available for review online at www.campbellsci.com.) Products not manufactured by CSI, but that are resold by CSI, are warranted only to the limits extended by the original manufacturer. Batteries, fine-wire thermocouples, desiccant, and other consumables have no warranty. CSI’s obligation under this warranty is limited to repairing or replacing (at CSI’s option) defective Products, which shall be the sole and exclusive remedy under this warranty. The Customer assumes all costs of removing, reinstalling, and shipping defective Products to CSI. CSI will return such Products by surface carrier prepaid within the continental United States of America. To all other locations, CSI will return such Products best way CIP (port of entry) per Incoterms ® 2010. This warranty shall not apply to any Products which have been subjected to modification, misuse, neglect, improper service, accidents of nature, or shipping damage. This warranty is in lieu of all other warranties, expressed or implied. The warranty for installation services performed by CSI such as programming to customer specifications, electrical connections to Products manufactured by CSI, and Product specific training, is part of CSI’s product warranty. **CSI EXPRESSLY DISCLAIMS AND EXCLUDES ANY IMPLIED WARRANTIES OF MERCHANTABILITY OR FITNESS FOR A PARTICULAR PURPOSE. CSI hereby disclaims, to the fullest extent allowed by applicable law, any and all warranties and conditions with respect to the Products, whether express, implied or statutory, other than those expressly provided herein.**”

Assistance

Products may not be returned without prior authorization. The following contact information is for US and international customers residing in countries served by Campbell Scientific, Inc. directly. Affiliate companies handle repairs for customers within their territories. Please visit www.campbellsci.com to determine which Campbell Scientific company serves your country.

To obtain a Returned Materials Authorization (RMA) number, contact CAMPBELL SCIENTIFIC, INC., phone (435) 227-9000. Please write the issued RMA number clearly on the outside of the shipping container. Campbell Scientific's shipping address is:

CAMPBELL SCIENTIFIC, INC.

RMA# _____
815 West 1800 North
Logan, Utah 84321-1784

For all returns, the customer must fill out a "Statement of Product Cleanliness and Decontamination" form and comply with the requirements specified in it. The form is available from our website at www.campbellsci.com/repair. A completed form must be either emailed to repair@campbellsci.com or faxed to (435) 227-9106. Campbell Scientific is unable to process any returns until we receive this form. If the form is not received within three days of product receipt or is incomplete, the product will be returned to the customer at the customer's expense. Campbell Scientific reserves the right to refuse service on products that were exposed to contaminants that may cause health or safety concerns for our employees.

Safety

DANGER — MANY HAZARDS ARE ASSOCIATED WITH INSTALLING, USING, MAINTAINING, AND WORKING ON OR AROUND TRIPODS, TOWERS, AND ANY ATTACHMENTS TO TRIPODS AND TOWERS SUCH AS SENSORS, CROSSARMS, ENCLOSURES, ANTENNAS, ETC. FAILURE TO PROPERLY AND COMPLETELY ASSEMBLE, INSTALL, OPERATE, USE, AND MAINTAIN TRIPODS, TOWERS, AND ATTACHMENTS, AND FAILURE TO HEED WARNINGS, INCREASES THE RISK OF DEATH, ACCIDENT, SERIOUS INJURY, PROPERTY DAMAGE, AND PRODUCT FAILURE. TAKE ALL REASONABLE PRECAUTIONS TO AVOID THESE HAZARDS. CHECK WITH YOUR ORGANIZATION'S SAFETY COORDINATOR (OR POLICY) FOR PROCEDURES AND REQUIRED PROTECTIVE EQUIPMENT PRIOR TO PERFORMING ANY WORK.

Use tripods, towers, and attachments to tripods and towers only for purposes for which they are designed. Do not exceed design limits. Be familiar and comply with all instructions provided in product manuals. Manuals are available at www.campbellsci.com or by telephoning (435) 227-9000 (USA). You are responsible for conformance with governing codes and regulations, including safety regulations, and the integrity and location of structures or land to which towers, tripods, and any attachments are attached. Installation sites should be evaluated and approved by a qualified engineer. If questions or concerns arise regarding installation, use, or maintenance of tripods, towers, attachments, or electrical connections, consult with a licensed and qualified engineer or electrician.

General

- Prior to performing site or installation work, obtain required approvals and permits. Comply with all governing structure-height regulations, such as those of the FAA in the USA.
- Use only qualified personnel for installation, use, and maintenance of tripods and towers, and any attachments to tripods and towers. The use of licensed and qualified contractors is highly recommended.
- Read all applicable instructions carefully and understand procedures thoroughly before beginning work.
- Wear a **hardhat** and **eye protection**, and take **other appropriate safety precautions** while working on or around tripods and towers.
- **Do not climb** tripods or towers at any time, and prohibit climbing by other persons. Take reasonable precautions to secure tripod and tower sites from trespassers.
- Use only manufacturer recommended parts, materials, and tools.

Utility and Electrical

- **You can be killed** or sustain serious bodily injury if the tripod, tower, or attachments you are installing, constructing, using, or maintaining, or a tool, stake, or anchor, come in **contact with overhead or underground utility lines**.
- Maintain a distance of at least one-and-one-half times structure height, 20 feet, or the distance required by applicable law, **whichever is greater**, between overhead utility lines and the structure (tripod, tower, attachments, or tools).
- Prior to performing site or installation work, inform all utility companies and have all underground utilities marked.
- Comply with all electrical codes. Electrical equipment and related grounding devices should be installed by a licensed and qualified electrician.

Elevated Work and Weather

- Exercise extreme caution when performing elevated work.
- Use appropriate equipment and safety practices.
- During installation and maintenance, keep tower and tripod sites clear of un-trained or non-essential personnel. Take precautions to prevent elevated tools and objects from dropping.
- Do not perform any work in inclement weather, including wind, rain, snow, lightning, etc.

Maintenance

- Periodically (at least yearly) check for wear and damage, including corrosion, stress cracks, frayed cables, loose cable clamps, cable tightness, etc. and take necessary corrective actions.
- Periodically (at least yearly) check electrical ground connections.

WHILE EVERY ATTEMPT IS MADE TO EMBODY THE HIGHEST DEGREE OF SAFETY IN ALL CAMPBELL SCIENTIFIC PRODUCTS, THE CUSTOMER ASSUMES ALL RISK FROM ANY INJURY RESULTING FROM IMPROPER INSTALLATION, USE, OR MAINTENANCE OF TRIPODS, TOWERS, OR ATTACHMENTS TO TRIPODS AND TOWERS SUCH AS SENSORS, CROSSARMS, ENCLOSURES, ANTENNAS, ETC.

Table of Contents

PDF viewers: These page numbers refer to the printed version of this document. Use the PDF reader bookmarks tab for links to specific sections.

| | |
|--|-----------|
| 1. Introduction | 1 |
| 2. Precautions | 1 |
| 3. Initial Inspection | 1 |
| 3.1 TDR200 Packing List | 2 |
| 3.2 SDM8X50 Packing List | 2 |
| 3.3 ENCTDR100 Packing List | 2 |
| 4. QuickStart | 2 |
| 5. Overview | 6 |
| 6. Specifications | 7 |
| 6.1 TDR200 Performance | 7 |
| 6.2 Electromagnetic Compatibility | 8 |
| 6.3 SDM8X50 Major Specifications | 9 |
| 7. Installation | 9 |
| 7.1 System Components: Data Logger Control | 9 |
| 7.1.1 Data Logger | 10 |
| 7.1.2 TDR200 | 10 |
| 7.1.3 SDM8X50 | 10 |
| 7.1.4 Power Supply | 11 |
| 7.1.4.1 Grounding | 11 |
| 7.1.5 SDM Communication | 12 |
| 7.1.6 ENCTDR100 | 12 |
| 7.1.6.1 Mounting Equipment in ENCTDR100 | 12 |
| 7.1.7 Soil Probes | 13 |
| 7.1.7.1 Determining Probe Constant, K_p , using PC-TDR | 14 |
| 7.2 Programming | 14 |
| 7.2.1 TDR200() CRBasic Instruction | 14 |
| 7.2.2 PortsConfig CRBasic Instruction | 15 |
| 8. Operation | 15 |
| 8.1 TDR Principles | 15 |
| 8.2 Cable Length Effect on Water Content Measurement | 16 |
| 8.3 Soil Electrical Conductivity Effect on Water Content Measurement | 17 |
| 8.4 Filtering and Averaging | 19 |
| 8.5 Algorithms for Calculation of TDR Probe Rod Apparent Length | 19 |
| 8.5.1 Legacy Algorithm | 19 |
| 8.5.2 Tangent Line Algorithm | 19 |

8.5.3 Second-Order Bounded Mean Oscillation (BMO) Algorithm20
 8.6 Algorithm for Calculation of Bulk Electrical Conductivity20

9. References 21

Appendices

A. Example Program A-1

B. Calibration Wizard Tutorial B-1

C. Terminal Commands C-1

C.1 About Notation Used in this DocumentC-2
 C.2 Commands Requiring a Parameter.....C-2
 C.3 Commands Without a Parameter.....C-2
 C.4 Responses.....C-2
 C.4.1 Error Response.....C-3
 C.4.2 Ack Response.....C-3
 C.4.3 Value Response.....C-3
 C.5 Command Usage and Responses.....C-3

Figures

7-1. TDR System Components10
 7-2. Terminal strip adapters for connections to battery11
 7-3. ENCTDR100 with SDM8X50, PS150, TDR200, and CR100013
 8-1. Waveforms collected in a sandy loam using CS610 probe with
 RG8 connecting cable. Volumetric water content is 24% and
 bulk electrical conductivity is 0.3 dS m⁻¹.17
 8-2. Waveforms collected in a sandy loam using CS610 probe with
 RG8 connecting cable. Volumetric water content values are
 0.10, 0.16, 0.18, 0.21, and 0.25. Solution electrical conductivity
 is 1.0 dS m⁻¹.....18
 8-3. Waveforms collected in a sandy loam using CS610 probe with
 RG8 connecting cable. Volumetric water content values are
 0.10, 0.18, 0.26, 0.30, and 0.37. Solution electrical conductivity
 is 10.2 dS m⁻¹.....18

CRBasic Example

A-1. TDR200 Program Using One CS635 Connected to the SDM8X50 .. A-1

TDR200-Based Time-Domain Reflectometry System

1. Introduction

The TDR200 is the core of the Campbell Scientific time-domain reflectometry (TDR) system, which accurately monitors soil volumetric water content, soil bulk electrical conductivity, rock mass deformation, slope stability, or user-specific time-domain measurements. Campbell Scientific's TDR system consists of the TDR200, a data logger, SDM8X50 coaxial multiplexers, TDR probes, and *PC-TDR* software.

NOTE This manual provides information only for CRBasic data loggers. The TDR200 is not compatible with Edlog data loggers.

2. Precautions

- READ AND UNDERSTAND the *Safety* section at the front of this manual.
- **WARNING:** Because the TDR200 is sensitive to electrostatic discharge damage, avoid touching the inner part of the panel BNC connector or the center rod of TDR probes connected to the TDR200.
- The maximum recommended total length of all synchronous device for measurement (SDM) cables should not exceed 500 feet. Longer total lengths cause unreliable communication between SDM devices.
- The insulation for the individual wires of the SDM cable affects the frequency response and reliability. PVC insulation has more attenuation than polypropylene or polyurethane and should not be used for SDM communication except when total SDM cable length is less than 250 feet.
- Although the TDR200, SDM8X50 multiplexers, and TDR probes are rugged, they should be handled as precision scientific instruments.

3. Initial Inspection

- Upon receipt of the equipment, inspect the packaging and contents for damage. File damage claims with the shipping company.
- Check the contents of the shipment (see Section 3.1, *TDR200 Packing List* (p. 2), Section 3.2, *SDM8X50 Packing List* (p. 2), and Section 3.3, *ENCTDR100 Packing List* (p. 2)). If there is a shortage, contact Campbell Scientific.

3.1 TDR200 Packing List

The following are included with a TDR200:

- TDR200 Time-Domain Reflectometer
- 6 to 6.5 ft, USB type-A-to-Micro-B cable for connection between the TDR200 and a computer
- Short 5-conductor cables for SDM connection between the data logger and the TDR200 and between the TDR200 and an SDM8X50 coaxial multiplexer

3.2 SDM8X50 Packing List

The following are included with the SDM8X50:

- SDM8X50 8-channel 50 Ohm coaxial multiplexer
- 8 #6-32 x .375 pan Philips screws
- 8 grommets for #6 or #8 screws
- 20 4-inch nylon cable ties
- Strain relief bracket with 12 cable tie mounts

When purchased with the –E option, the following items will also be included:

- ENC10/12 enclosure with mounting hardware
- Enclosure supply kit

3.3 ENCTDR100 Packing List

The following are included with an ENCTDR100:

- Enclosure Supply Kit that includes desiccant packs, humidity indicator, cable ties, putty, and mounting hardware
- ENCTDR100 Enclosure Ground Wire Kit
- TDR200/SDM8X50 Coaxial Interconnect Cable
- TDR200/SDM8X50 and TDR200/Data Logger SDM 5-Conductor Cable
- ENC16/18 Enclosure with two 1.7-inch diameter cable penetration ports
- Terminals for external deep cycle battery

4. QuickStart

For simplicity, this section lists steps for a connection between a computer and the TDR200 to monitor a single TDR probe (no multiplexer) using *PC-TDR* software. TDR200 operation with SDM8X50 multiplexers is described in Section 7.1.3, *SDM8X50* (p. 10), and *PC-TDR Help*.

1. Download *PC-TDR* at www.campbellsci.com/downloads.
2. Use the supplied Type A to Micro B male USB cable to connect the computer to the USB port on the TDR200. The TDR200 is typically powered via the USB port during setup.
3. Connect a TDR probe to the BNC connector of the TDR200.

4. Start *PC-TDR* by selecting **PC-TDR** under Programs of the Windows Start Menu or double-clicking  (the *PC-TDR* icon).
5. Select TDR200 and close the dialog box by pressing **OK**.

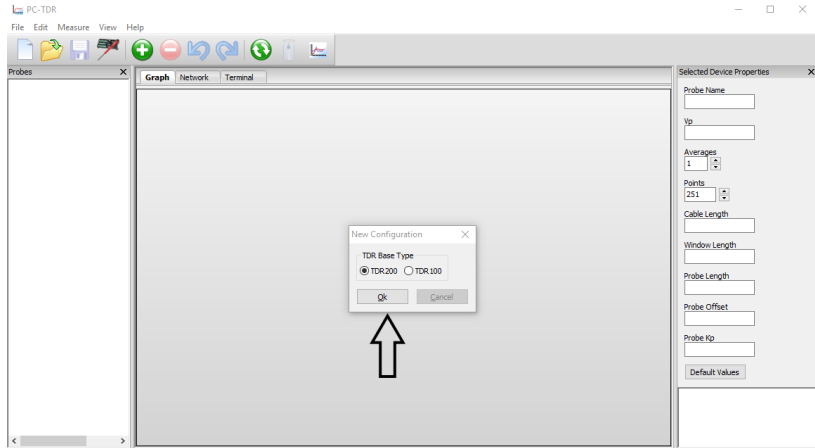

6. If the USB driver has not been installed, select the **Install Driver** button. After the USB driver has been installed, select the **Serial Port**.

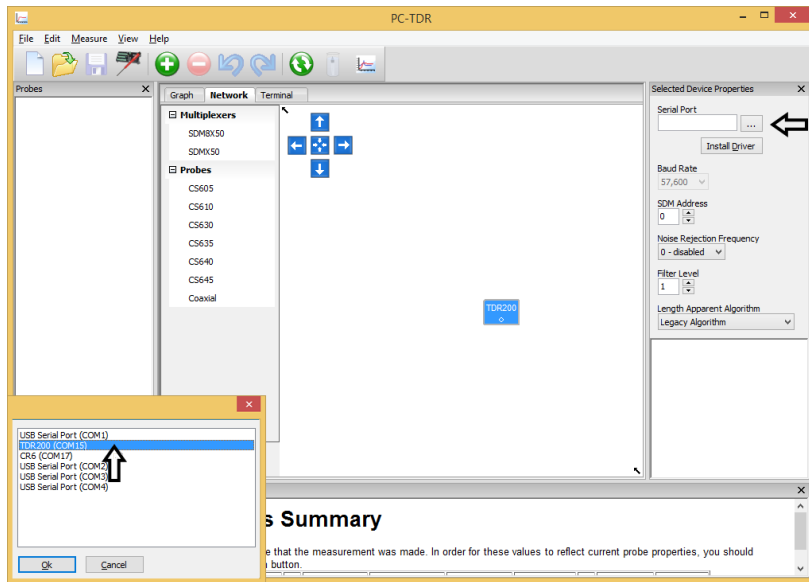

7. Typically, use the default baud rate of 57,600. The **SDM Address** must match the address of the TDR200. For **Noise Rejection Frequency**, select 50 Hz or 60 Hz rejection if the system is near AC power lines. The **TDR Filter Level** setting is used to reduce noise from the TDR trace by applying a weighted moving average (arithmetic convolution) to the data points (Section 8.4, *Filtering and Averaging* (p. 19)). The **Second BMO** option for the **Length Apparent Algorithm** provides better measurements in noisy environments or when using short probes.

8. Select the probe from the list on the left panel, confirm the parent device and device type, and click **Ok**.

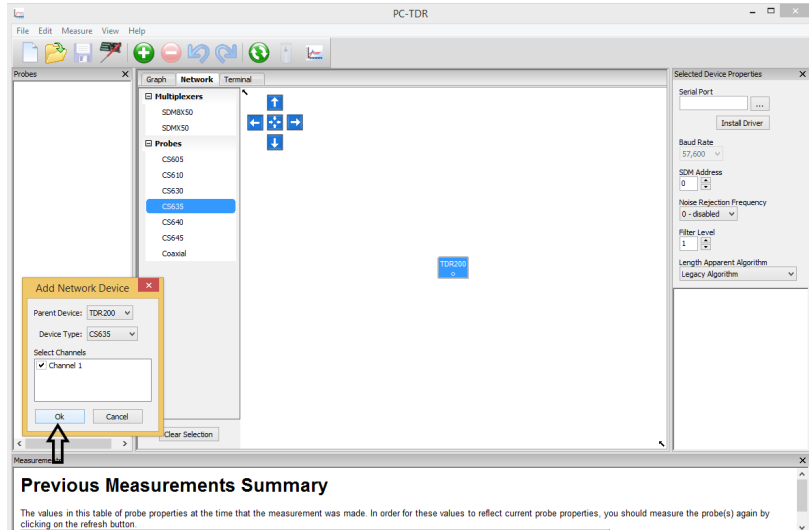



9. In the right pane, enter the **Cable Length** (required). **Cable Length**, **Window Length**, **Probe Length**, and **Probe Offset** settings will be automatically entered when using the Calibration Wizard (Appendix B, *Calibration Wizard Tutorial* (p. B-1)).

NOTE

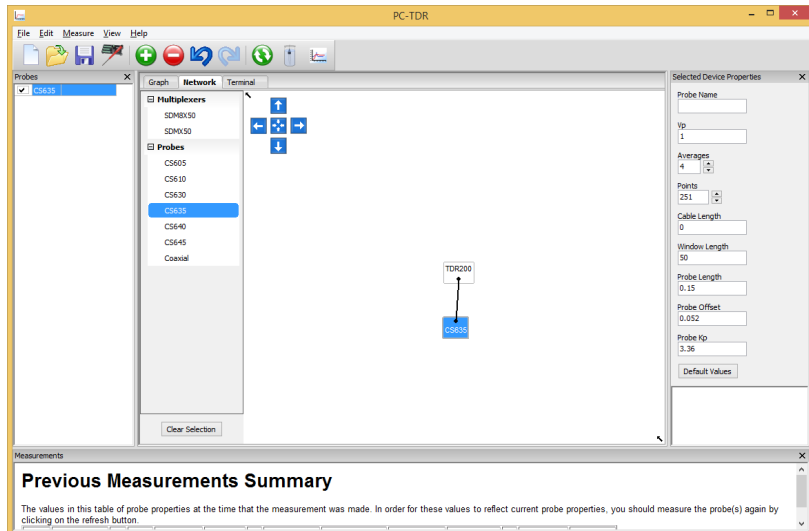
Before using the Calibration Wizard, physically connect all multiplexers and sensors the way they will be permanently deployed. Then add multiplexers and sensors in the Network tab to match the physical setup. This will ensure that the Calibration Wizard determines all measurement parameters correctly.



10. Select  to generate a CRBasic program.

11. Enter a name for the CRBasic program. Click  to specify where to save the program and what type of program to generate. Press **Next**.

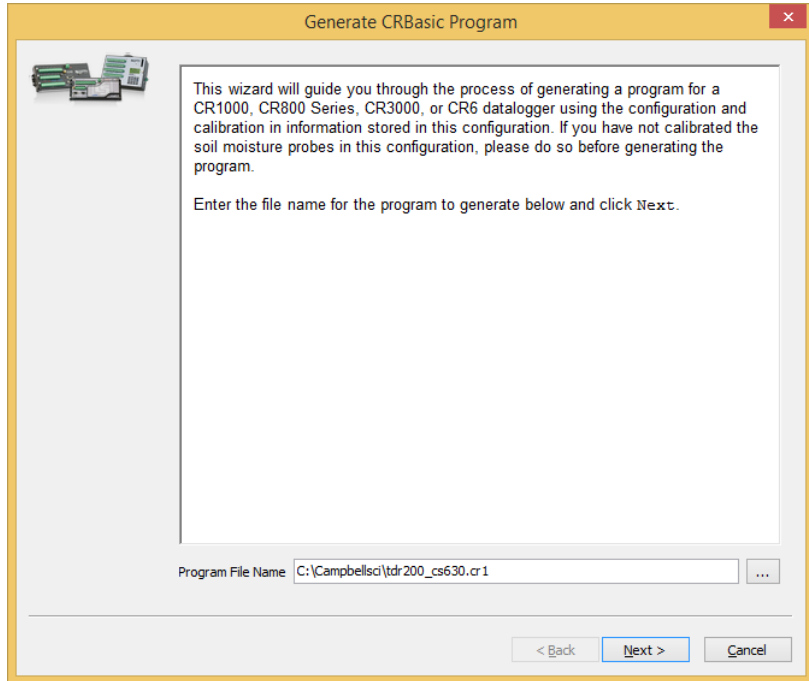

12. Select what is measured and stored, as well as time intervals for measurements. Click **Next**.

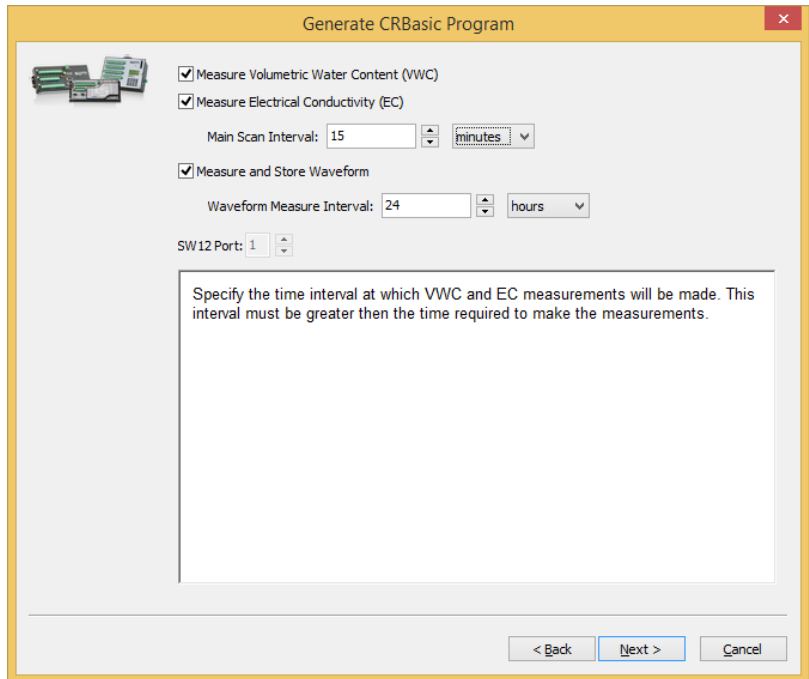

13. Select **Open in CRBasic** to open the generated code in the *CRBasic Editor* and make any desired changes. Press **Finish** to exit the program generator wizard.

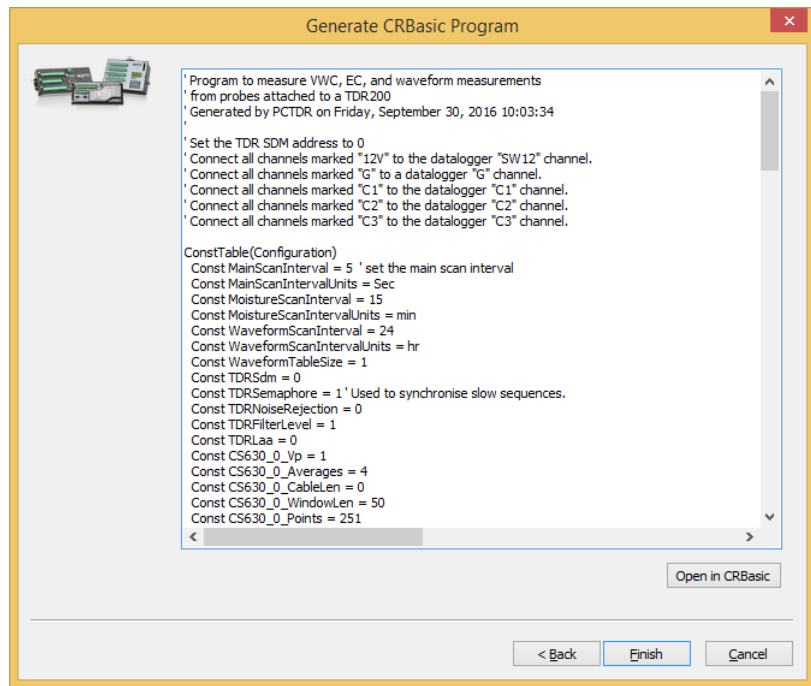

5. Overview

The TDR200 generates a short rise time electromagnetic pulse that is applied to a coaxial system and samples and digitizes the resulting reflection waveform for analysis or storage. It has a single BNC connector for communication with an attached coaxial cable.

To measure multiple sensors, the TDR200 requires one or more SDM8X50 coaxial multiplexers. The SDM8X50 is a 50 ohm, coaxial, eight-to-one multiplexer. It consists of a surge-protected multiplexer circuit board enclosed in a metal housing and a separate strain-relief bracket for the coaxial cables. Both the multiplexer housing and the strain relief bracket have holes drilled at a 1-inch spacing. This allows the SDM8X50 to be mounted to a wall or attached to the backplate of a user-supplied enclosure or Campbell Scientific enclosure. When purchased with the –E option, the SDM8X50 includes a 25 x 30 x 12 cm (10 x 12 x 5 in) environmental enclosure and an enclosure supply kit. Other compatible Campbell Scientific enclosures that may be purchased separately include the ENCTDR100, ENC12/14, ENC14/16, and ENC16/18.

NOTE

The TDR200 is also compatible with the SDMX50-series coaxial multiplexers. For information about using the TDR200 with these coaxial multiplexers, see an older manual at www.campbellsci.com/old-manuals.

The TDR200 is controlled by a computer using *PC-TDR* 3.0 or higher software or by a data logger. Compatible data loggers include the CR6 series, CR800

series, CR1000X, CR1000, and CR3000, which use the **TDR200()** CRBasic instruction. *PC-TDR* software includes a Calibration Wizard, displays waveform information, troubleshoots the reflectometer, and generates a CRBasic program.

NOTE Software developers can customize the user interface using information provided in Appendix C, *Terminal Commands* (p. C-1).

A TDR system consisting of a data logger, TDR200, SDM8X50 multiplexers, 12 V power supply, weatherproof enclosure, and solar panel is used to get automated measurements at prescribed time intervals. A single TDR probe can be connected directly to the TDR200 or multiple probes connected using SDM8X50 coaxial multiplexers.

For field applications, the ENCTDR100 enclosure is recommended. The ENCTDR100 is a white, fiberglass reinforced enclosure that protects the TDR200 and other system components from weather, condensing humidity, and dust.

6. Specifications

Features:

- Uses compact, low-cost TDR200 with performance features that match or exceed other available reflectometers
- Makes non-destructive, long-term, in-situ soil measurements
- Provides measurement time of 2 s for water content, electrical conductivity or reflection waveform collection (250 data points)
- Measures up to 512 TDR probes
- Uses *PC-TDR* software to facilitate system setup
- Compatible with Campbell Scientific CRBasic data loggers: CR6 series, CR800 series, CR1000, and CR3000

PC-TDR 3.0 requirements: Runs on Windows 10, 8, 7, and Vista

Compliance information: View EU Declaration of Conformity documentation at:
www.campbellsci.com/tdr200

6.1 TDR200 Performance

| | |
|--|---|
| Pulse generator output: | 250 mV into 50 ohms |
| Output impedance: | 50 $\Omega \pm 1\%$ |
| Time response of combined pulse generator and sampling circuit: | ≤ 85 ps |
| Pulse generator aberrations: | $\pm 16\%$ within first 1 ns; $\pm 1\%$ after 1 ns |
| Pulse length: | 25.5 μ s |
| Operating frequency: | Band centered around 11.75 GHz |

| | | |
|--|--|-----------------------|
| Waveform sampling: | 20 to 10112 waveform values over chosen length | |
| | distance | time |
| | ($V_p = 1$) | (1 way travel) |
| Range: | 0 to 3800 m | 0 to 27.75 μ s |
| Resolution: | 1.35 mm | < 4.4 ps |
| Waveform averaging: | 1 to 128 | |
| Electrostatic discharge protection: | ± 8 kV @ 2 Ω air | |
| | ± 4 kV @ 2 Ω contact | |
| Surge protection: | ± 2 kV @ 2 Ω | |
| Power supply: | Unregulated 12 VDC (9.6 to 16 VDC), 150 mA maximum , USB powered (5 VDC) | |
| Current drain | | |
| During measurement: | 120 mA | |
| Sleep mode: | 1 mA | |
| Temperature range: | -40 to 85 $^{\circ}$ C | |
| Height: | 10.7 cm (4.2 in) | |
| Width: | 5.1 cm (2.0 in) | |
| Length | 21.6 cm (8.5 in) | |
| Weight: | 0.79 kg (1.75 lb) | |

6.2 Electromagnetic Compatibility

The TDR200 is CE compliant with performance criteria available upon request. RF emissions are below EN55022 limit. The TDR200 meets EN61326 requirements for protection against electrostatic discharge and surge except for electrostatic discharge on the center conductor of the panel BNC connector.

WARNING

The TDR200 is sensitive to electrostatic discharge damage. Avoid touching the center conductor of the panel BNC connector or the center rod of TDR probes connected to the TDR200.

6.3 SDM8X50 Major Specifications

| | Consists of | Size | When Used |
|---|--|--|---|
| SDM8X50 50 Ohm Coaxial Multiplexer | Multiplexer circuit board encased in metal housing and a separate strain relief bracket. Both the circuit board and bracket include mounting holes and hardware for attaching them to the backplate of an enclosure (typically the ENCTDR100) or to a wall. | Weight: 590 g (1.3 lb) Multiplexer Housing Dimensions with Mounts: 25 x 12 x 5 cm (10 x 5 x 2 in) Strain Relief Bracket Dimensions: 20 x 4 x 1 cm (8 x 2 x 0.5 in) | When the multiplexer will be housed in the same enclosure as the data logger and power supply or when the multiplexer will reside in a building |
| SDM8X50-E | SDM8X50 multiplexer with an ENC10/12 environmental enclosure. Enclosure includes a bracket for mounting to a tripod, a tower, or a 1.0 in. to 1.25 in. IPS Schedule 40 pipe. | Weight: 4.4 kg (9.8 lb) Enclosure Outside Dimensions with Mounts: 40 x 29 x 17.5 cm (16 x 12 x 7 in) Enclosure Inside Dimensions: 25 x 30 x 13 cm (10 x 12 x 5 in) | When the multiplexer will be housed in its own enclosure without the data logger and power supply |

- Temperature range:** -40 to 55 °C
- Input power:** 12 VDC
- Quiescent current drain:** < 1 mA
- Current drain during switching:** ~90 mA (all multiplexers of the same level switch simultaneously for less than 1 s. See FIGURE 7-1, *TDR System Components (p. 10).*)
- Relay contact life expectancy:** 100 x 10⁶ operations

7. Installation

7.1 System Components: Data Logger Control

FIGURE 7-1 shows the three multiplexer levels allowing up to 512 probes to be measured. The first level includes the TDR200 and one multiplexer. Up to eight coaxial cables connect to each multiplexer. The coaxial cables can be connected to TDR probes or the next level multiplexers.

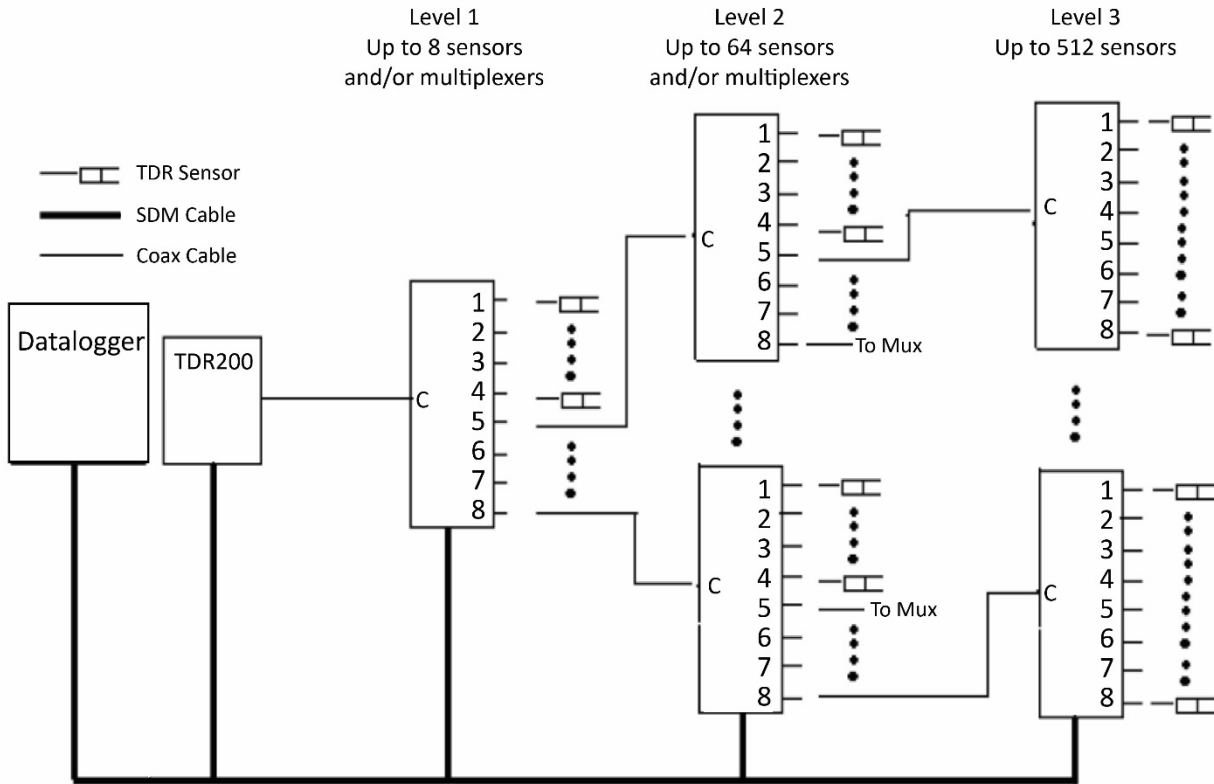

FIGURE 7-1. TDR System Components

7.1.1 Data Logger

Campbell Scientific CR6-series, CR800-series, CR1000X, CR1000, and CR3000 data loggers are used in a TDR system to automatically control the TDR200, SDM8X50 multiplexers, and telemetry for obtaining measurement results remotely. Refer to Section 7.2, *Programming (p. 14)*, for more information.

7.1.2 TDR200

The TDR200 contains the pulse generator for the signal applied to a TDR sensor. It also digitizes the reflection and applies numerical algorithms for measuring volumetric water content or electrical conductivity. The TDR200 communicates with the data logger using SDM protocol or with a computer using *PC-TDR* and serial communications.

7.1.3 SDM8X50

The SDM8X50 is a 50 ohm, eight-to-one, coaxial multiplexer designed to minimize signal attenuation. All SDM8X50 channels have equal transmission line lengths. Spark gaps protect against voltage surge damage. Hermetically sealed, non-latching electromechanical relays are activated to connect the TDR200 to different multiplexer channels. After a 30 second timeout, the relays unlatch providing additional surge protection. Relays used on the ground and signal lines fully isolate each sensor during measurements.

Each of the eight ports can be connected to a probe or another multiplexer (see FIGURE 7-1, *TDR System Components (p. 10)*).

7.1.4 Power Supply

The system operates on 12 VDC power. A user-supplied deep cycle 12 V lead-acid battery is commonly used in remote installations. Two terminal strip adapters for the battery posts are provided with the ENCTDR100 (see FIGURE 7-2). These terminal strips will mount to wing nut battery posts found on most deep cycle lead-acid batteries. Installations with AC power available should use it to continuously charge the system battery. Remote installation without AC power should keep the battery charged with an SP10R or SP20R solar panel. See the applications note at <ftp://ftp.campbellsci.com/pub/outgoing/apnotes/pow-sup.pdf> for discussion of power supplies.

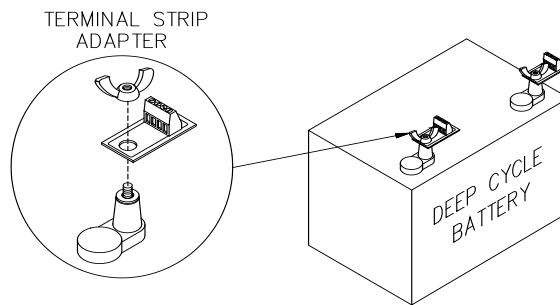

FIGURE 7-2. Terminal strip adapters for connections to battery

Campbell Scientific recommends using the data logger switched 12 V port to power the TDR200. This practice reduces power consumption and resets the TDR200, which provides automatic recovery from system malfunctions and reduces loss of measurement data when a problem exists.

The SW12() CRBasic instruction can switch 12 V power on and off. Typically, switch the 12 V power on at the beginning of the data logger program table that contains the TDR measurement instructions, and switch the power off at the end of the table. For more information, refer to Appendix A, *Example Program (p. A-1)*.

7.1.4.1 Grounding

Install the TDR system with a single ground point. A good earth ground should be established close to the data logger/TDR200.

A copper clad grounding rod comes with the CM106B tripod. The UTGND kit provides hardware needed for grounding rod use.

The data loggers, TDR200, and SDM8X50 have grounding lugs. These lugs should be tied together with short pieces of grounding wire no smaller than 12 AWG. The ENCTDR100 has a grounding lug in the lower left corner of the enclosure. A 10 AWG wire is provided for connection to the components in the enclosure. A short run of heavy-gauge (10 AWG or heavier) wire should be connected from the enclosure lug to earth ground.

The ground lug on peripheral SDM8X50 multiplexer enclosures should only be used if the multiplexer is near enough to conveniently use the same ground point as the data logger.

7.1.5 SDM Communication

The TDR200, SDM8X50 multiplexers, and data loggers use synchronous device for measurement (SDM) communication protocol to control measurements and transfer data. This communication protocol adheres to an addressing scheme for all communicating devices.

The address selected on the TDR200 must match the SDM address used in the data logger program. The three multiplexer levels (FIGURE 7-1, *TDR System Components (p. 10)*) use the following addressing scheme:

- Level 1 multiplexer—address value equal to the TDR200 address plus 1.
- Level 2 multiplexers—address value equal to the TDR200 address plus 2.
- Level 3 multiplexers—address value equal to the TDR200 address plus three.

Set the address for SDM8X50 multiplexers using the thumbwheel switch at the top of the panel.

A 5-conductor cable with shield and drain is shipped with the TDR200 and ENCTDR100 for connecting the data logger to the TDR200 and the TDR200 to an SDM8X50. If additional cables are needed to connect different levels of multiplexers, use the CABLE5CBL-L cable. The maximum total length of all SDM cables should not exceed 500 feet to ensure reliable communication between SDM devices.

The red and black wires are typically used for 12 VDC and ground. The remaining three wires connect the control lines (data, clock, enable). On the CR6-series, CR800-series, CR1000X, and CR1000 data loggers, the ports labeled **C1**, **C2**, and **C3** are dedicated to data, clock, and enable, respectively (FIGURE 7-3, *ENCTDR100 with SDM8X50, PS150, TDR200, and CR1000 (p. 13)*). The CR6 can also use universal channels (**U1**, **U2**, **U3** or **U5**, **U6**, **U7** or **U9**, **U10**, **U11**). On the CR3000, the ports are labeled **SDM-C1**, **SDM-C2**, and **SDM-C3**.

7.1.6 ENCTDR100

Many TDR system applications require installation of equipment at field sites. The ENCTDR100 is a weatherproof enclosure with a mounting plate for a data logger, power supply, TDR200, SDM8X50, cable strain relief bracket, and associated cabling. The ENCTDR100 can be mounted on a CM106B tripod for a free-standing installation.

7.1.6.1 Mounting Equipment in ENCTDR100

The ENCTDR100 is a 16-inch-by-18-inch weathertight enclosure modified for use with a Campbell Scientific TDR system (FIGURE 7-3). It includes the following:

- Enclosure supply kit consisting of desiccant packs, humidity indicator, cable ties, putty and mounting hardware
- ENCTDR100 Enclosure Ground Wire Kit

- TDR200/SDM8X50 Coaxial Interconnect Cable (18 inch length)
- TDR200/SDM8X50 and TDR200/data logger SDM 5-conductor cable
- ENC16/18 enclosure with two 1.7-inch diameter cable ports
- Terminals for external deep cycle battery

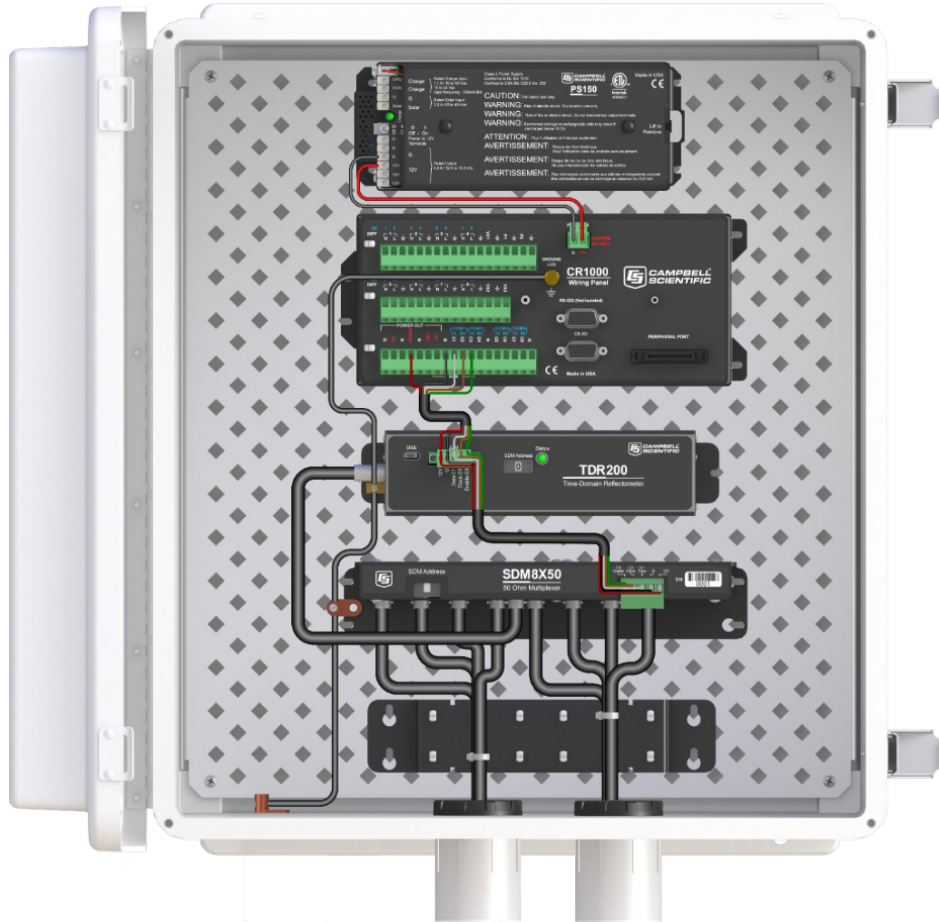

FIGURE 7-3. ENCTDR100 with SDM8X50, PS150, TDR200, and CR1000

7.1.7 Soil Probes

The TDR probes are the sensors of the TDR measurement system and are inserted into the medium to be measured. The probes are a waveguide extension on the end of coaxial cable. Reflections of the applied signal along the waveguide will occur where there are impedance changes. The impedance value is related to the geometrical configuration of the probe (size and spacing of rods) and also is inversely related to the dielectric constant of the surrounding material. A change in volumetric water content of the medium surrounding the probe causes a change in the dielectric constant. This is seen as a change in probe impedance, which affects the shape of the reflection. The shape of the reflection contains information used to determine water content. Both volumetric water content and electrical conductivity can be measured using fixed spacing 2-rod designs and 3-rod designs. Campbell Scientific manufactures 3-rod TDR probes with rod lengths ranging from 0.075 m to 0.3 m.

7.1.7.1 Determining Probe Constant, K_p , using PC-TDR

Section 8.1, *TDR Principles* (p. 15), presents the principles for TDR measurements of soil electrical conductivity. The result of the measurement must be multiplied by the probe constant (K_p) to give bulk electrical conductivity in S/m (Siemens/meter). The K_p value can be measured using *PC-TDR* by following the instructions in the **Calibrate Probe** wizard (Appendix B, *Calibration Wizard Tutorial* (p. B-1)). The method requires submersion of the TDR probe rods in deionized water of known temperature.

7.2 Programming

PC-TDR software is used for system setup and troubleshooting. It displays volumetric water content and electrical conductivity, switches multiplexer channels, collects waveform and derivative data files, and determines probe constant values needed for electrical conductivity measurements. It has a Calibration Wizard that will automatically populate many of the sensor settings. *PC-TDR* will also generate a CRBasic program.

The program generator wizard is accessible from the **File** menu and by clicking



. Additional editing of the program can be performed using the *CRBasic Editor*. This is useful when there are devices and sensors added to the TDR system that are not supported by *PC-TDR* program generator. CRBasic is included in *PC400* or *LoggerNet* software.

The **TDR200()** CRBasic instruction is used to program the TDR200. Programming basics are provided in the following sections. A complete program example for a CRBasic data logger can be found in Appendix A, *Example Program* (p. A-1).

NOTE

If the data logger and *PC-TDR* are simultaneously measuring the TDR200, an error will occur in either the data logger data stream or *PC-TDR*. The error can be prevented by halting the data logger program while controlling the TDR200 with *PC-TDR*. To halt the CRBasic program, go to **File Control | Stop Program**. Make sure to restart the data logger program after using *PC-TDR*.

7.2.1 TDR200() CRBasic Instruction

The **TDR200()** CRBasic instruction measures one TDR probe connected to the TDR200 directly or multiple TDR probes connected to one or more SDM8X50 multiplexers.

```
TDR200(Dest(), SDMAAddress, Option, Mux/ProbeSelect, WaveAvg, Vp,
Points, CableLength, WindowLength, ProbeLength, ProbeOffset, Mult,
Offset, NoiseRejectionFreq, TDRFilterLevel, TDRLa)
```

The V_p parameter needs to be 1 if using a soil moisture probe. If using a coaxial sensor, the V_p parameter depends on the type of coaxial cable.

For the *NoiseRejectionFreq* parameter, choose 50 or 60 to eliminate 50 Hz or 60 Hz noise from AC lines (Section 8.4, *Filtering and Averaging* (p. 19)).

The *TDRFilterLevel* parameter can reduce noise of the TDR trace by applying a weighted moving average to the data points (Section 8.4, *Filtering and*

Averaging (p. 19). Acceptable values are 0 (no filtering) to 10 (maximum filtering).

For the *TDR_{Laa}* parameter, option 2 is best for noisy environments or when the length of probes is short (Section 8.5, *Algorithms for Calculation of TDR Probe Rod Apparent Length* (p. 19)).

Additional descriptions of parameters are provided in in the *CRBasic Help*.

7.2.2 PortsConfig CRBasic Instruction

If using a CR800, CR850, or CR1000, the **PortsConfig()** CRBasic instruction may be needed at the end of the program. When the TDR200 is connected to the data logger for SDM control and SDM8X50 multiplexers are also connected, the **PortsConfig()** instruction is required to properly configure the control ports. If this is not done, *PC-TDR* will not control the multiplexers because the control ports present a low impedance to the SDM lines and this will load the signal issued by TDR200 when *PC-TDR* is used to control multiplexers.

`PortsConfig(&B00000111,&B00000000)`

8. Operation

This section discusses TDR principles, conditions that effect water content measurements, filtering and averaging used to improve measurements in noisy environments, and the algorithms used to calculate the measurements.

8.1 TDR Principles

The travel time for a pulsed electromagnetic signal along a waveguide is dependent on the velocity of the signal and the length of the waveguide. The velocity is dependent on the dielectric constant of the material surrounding the waveguide. This relationship can be expressed by

$$\Delta t = \frac{2L\sqrt{K_a}}{c} \quad [1]$$

Where K_a is the apparent dielectric constant, c is the velocity of electromagnetic signals in free space, Δt is the travel time, and L is the waveguide length. The dielectric constant of water relative to other soil constituents is high. Consequently, changes in volumetric water content can be directly related to the change in the dielectric constant of bulk soil material. Equation [1] can be simplified to express the apparent dielectric constant as the ratio of the apparent probe length ($L_a = c \Delta t/2$) to the real probe length.

$$\sqrt{K_a} = \frac{L_a}{L} \quad [2]$$

The relationship between dielectric constant and volumetric water content has been described by, among others, Topp et al. (1980) and Ledieu et al. (1986) in an empirical fashion using both polynomial and linear forms. These expressions are presented here since numerous research efforts show these

equations are appropriate for nearly all applications. With θ_v , the volumetric water content, the equation presented by Topp et al. (1980) is

$$\theta_v = -5.3 \cdot 10^{-2} + 2.92 \cdot 10^{-2} K_a - 5.5 \cdot 10^{-4} K_a^2 + 4.3 \cdot 10^{-6} K_a^3 \quad [3]$$

and that presented by Ledieu et al. (1986) is

$$\theta_v = 0.1138 \sqrt{K_a} - 0.1758 \quad [4]$$

The TDR200 generates a fast rise time pulse that is sent to the connecting cable and probe. Reflections over a specified length of transmission line are sampled and digitized. Discontinuities in cable impedance causes changes in the amplitude of the reflected signal. The travel time of the reflected signal is used with a velocity value to give distance information. A probe consisting of metal rods can be used as an extension of a coaxial cable. When the probe is inserted in the soil, the travel time of the applied pulse along the probe length depends on the soil water content. In general, as the water content increases, the travel time of the applied pulse increases. The reflected waveform of the probe can be used to identify the impedance transitions caused by the probe beginning and end. This information is then analyzed to determine soil water content.

While the velocity of the applied pulse along a waveguide is dependent on the dielectric constant of the material surrounding the waveguide, the amplitude of the reflected voltage is dependent on electrical conduction of the applied signal between probe rods. The presence of free ions in the soil solution causes attenuation of the applied signal. Theory presented by Giese and Tiemann (1975) has been applied to the measurement of soil bulk electrical conductivity. A commonly used expression is:

$$\sigma = \frac{K_p}{Z_c} \frac{1 - \rho}{1 + \rho} \quad [5]$$

where σ is the bulk electrical conductivity, K_p is a probe constant, Z_c is the cable impedance (50 ohm), and ρ is the reflection coefficient. The reflection coefficient is the ratio of the reflected voltage to the applied voltage and ranges between plus and minus one.

The components of the Campbell Scientific TDR system are designed to apply time-domain reflectometry for the determination of soil volumetric water content and bulk electrical conductivity as both hardware for the collection of data and software for communications and analysis of the data.

8.2 Cable Length Effect on Water Content Measurement

The determination of water content using the TDR system relies on the evaluation of a pulse reflection from the TDR probe. The pulse generated by the TDR200 and its reflections are subject to distortion during travel between the TDR200 and the TDR probe. The cable connecting the probe to the reflectometer has a characteristic impedance resulting in both resistive and reactive losses. Distortion of the waveform caused by cable impedance can introduce error into the water content determination.

FIGURE 8-1 presents waveforms collected from a 3-rod probe (CS610) with varying cable lengths. Increasing the cable length affects the rise time and amplitude of the reflection. The slopes and extrema used by the data logger algorithm to analyze the waveform are shifted by the cable losses resulting in an error. For the data shown in FIGURE 8-1, the water content measurement error using the 66-meter cable is about 1.5% volumetric water content when electrical conductivity is low. However, in saline soils, the error is higher. See Bilskie (1997) for complete results of the study.

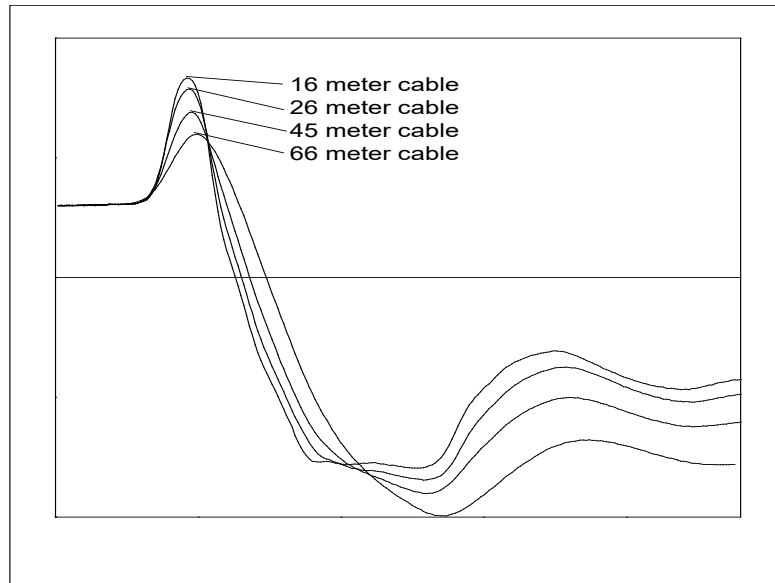

FIGURE 8-1. Waveforms collected in a sandy loam using CS610 probe with RG8 connecting cable. Volumetric water content is 24% and bulk electrical conductivity is 0.3 dS m^{-1} .

In general, water content is overestimated with increasing cable length. A calibration of volumetric water content with apparent dielectric constant for a given cable length can improve accuracy. Measurement precision at longer cable lengths will be maintained if the soil electrical conductivity does not prevent a reflection from the end of the probe rods. This is discussed later in this section.

Minimizing cable lengths should always be considered in the design of a measurement system using TDR. If long cable lengths are necessary, the adverse effects can be minimized by using low attenuation cable such as RG8. Careful probe design ensures correct probe impedance giving robust reflections. All TDR probes offered by Campbell Scientific are designed to optimize accuracy when longer cable lengths are used.

8.3 Soil Electrical Conductivity Effect on Water Content Measurement

The signal at the probe is attenuated when ionic conduction occurs in the soil solution. This inherent attenuation is used in TDR measurements to determine soil electrical conductivity as described by equation [5]. The presence of ions in the soil solution provides a path for electrical conduction between TDR

probe rods. The attenuation of the signal can affect the accuracy and resolution of water content measurements.

FIGURE 8-2 presents a series of waveforms when a solution with an electrical conductivity of 1.0 dS m^{-1} is added to a soil which has essentially no salt present. FIGURE 8-3 shows data for solution with high electrical conductivity.

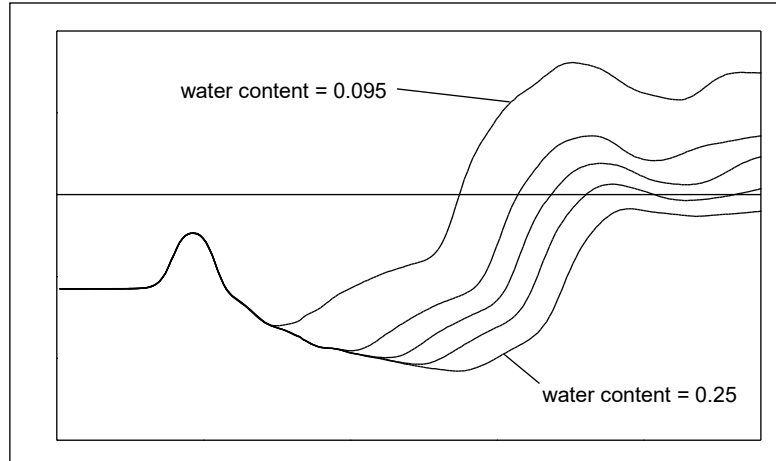

FIGURE 8-2. Waveforms collected in a sandy loam using CS610 probe with RG8 connecting cable. Volumetric water content values are 0.10, 0.16, 0.18, 0.21, and 0.25. Solution electrical conductivity is 1.0 dS m^{-1} .

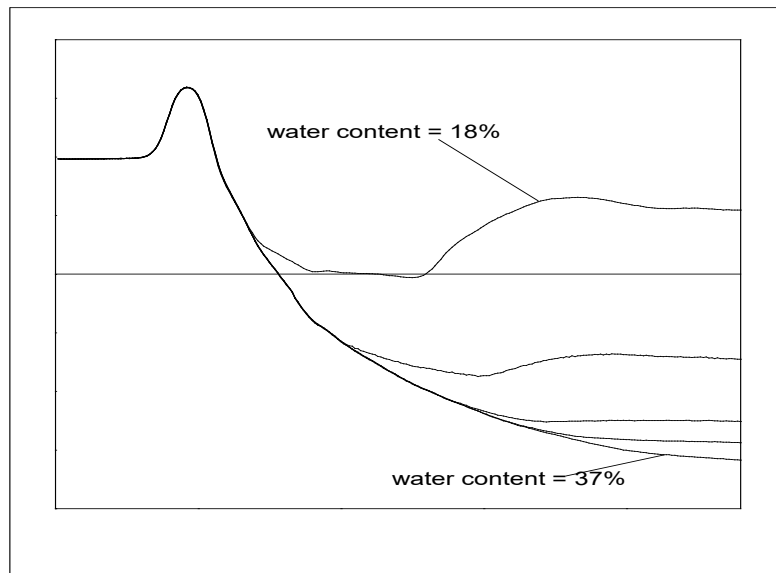

FIGURE 8-3. Waveforms collected in a sandy loam using CS610 probe with RG8 connecting cable. Volumetric water content values are 0.10, 0.18, 0.26, 0.30, and 0.37. Solution electrical conductivity is 10.2 dS m^{-1} .

The combined effect of long cable runs and high soil electrical conductivity must be considered when TDR measurements are taken.

8.4 Filtering and Averaging

The following parameters for the **TDR200** instruction are available for improving measurements in noisy environments.

Noise from AC power lines can be reduced by using the **Noise Rejection Frequency** setting. Option **50** takes two contiguous measurements that are exactly 10 ms out of phase to cancel 50 Hz noise. If the *WaveAvg* parameter is an odd number, the actual number of averages will be the next highest even integer. Option **60** takes two contiguous measurements that are exactly 8.33 ms out of phase in order to cancel 60 Hz noise. If the *WaveAvg* parameter is an odd number, the actual number of averages will be the next highest even integer.

The **TDR Filter Level** setting reduces noise from the TDR trace by applying a weighted moving average (arithmetic convolution) to the data points. The filter level determines the number of neighboring values to include in the weighted average. Acceptable values are 0 (no filtering) to 10 (maximum filtering). As an example, choosing a **Filter Level** of 2 will use five measured values in calculating the final output value: two values prior to the point of interest, the actual measured point of interest, and the two values after that point. Each of those points is weighted with the closer points having more weight than those further away.

The **WaveAvg** setting defines the number of waveform reflections averaged by the TDR200 to give a single result. A waveform averaging value of 4 provides good signal-to-noise ratio under typical applications. Under high noise conditions, averaging can be increased. The maximum averaging possible is 128.

8.5 Algorithms for Calculation of TDR Probe Rod Apparent Length

Three algorithms are available for calculating the TDR probe apparent length.

8.5.1 Legacy Algorithm

The legacy algorithm was used with the TDR100, and is consistent over varying soils and water contents. However, the tangent-line and second-order bounded mean oscillation algorithms are better for noisy environments and short probe lengths. When using the legacy algorithm for calculating the probe apparent length, the measurements can be improved by increasing the points (10112 maximum) or using the methods provided in Section 8.4, *Filtering and Averaging* (p. 19). Details of the legacy algorithm are provided in the TDR100 manual.

8.5.2 Tangent Line Algorithm

This algorithm is the flat line method used in the **WinTDR** software package (Or et al. (2004)). It works well without any predefined waveform attributes and is more resistant to noisy environments than the legacy algorithm.

8.5.3 Second-Order Bounded Mean Oscillation (BMO) Algorithm

This algorithm is the best method for short probes and noisy environments. It combines the tangent line (Or et al. (2004)) and the second-order BMO methods (Wang et al. (2016)). The algorithm uses the tangent line method to narrow in on the region of the waveform where the second reflection appears, then uses the second-order BMO method to finalize the point representing the probe end.

8.6 Algorithm for Calculation of Bulk Electrical Conductivity

Section 8.1, *TDR Principles (p. 15)*, presents the equation and method used by the TDR200 to calculate bulk electrical conductivity. The electrical conductivity calculation uses waveform values for the region immediately before the TDR probe and values from about 200 meters from the TDR200. The value at the location before the probe is used to calculate the applied signal and the 200 meter values are used for the reflected signal. Each of these values are normalized by a value collected from inside the TDR200.

A brief description of the algorithm is presented here.

1. Begin at waveform data point 40 and search for the point of the maximum first derivative.
2. Calculate the location of the point halfway between the value of parameter 1 and the point of maximum first derivative.
3. Calculate the mean and standard deviation of waveform values between parameter 1 and the halfway point.
4. Calculate a threshold value using:

$$threshold = a \cdot (maximum\ derivative) + b \cdot (mean\ from\ step\ 3) + c \cdot (standard\ deviation\ from\ step\ 3)$$

The values for a, b, and c are 0, 1, and 2 respectively.

5. With the point of the maximum first derivative as the right hand point, define a window of 10 waveform values. Incrementally move this window toward the TDR200 until all values are less than the threshold calculated in step 4.
6. Calculate the average of this window of values and use for the applied signal.
7. Calculate the average of the last six waveform values and use for reflected signal.
8. Apply equation [5] of Section 8.1, *TDR Principles (p. 15)*, to calculate electrical conductivity.

9. References

- Bilskie, Jim. 1997. "Reducing Measurement Errors of Selected Soil Water Sensors. Proceedings of the International Workshop on Characterization and measurement of the hydraulic properties of unsaturated porous media. 387-396.
- Giese, K., and R. Tiemann. 1975. "Determination of the complex permittivity from thin-sample time domain reflectometry, Improved analysis of the step response waveform," *Adv. Molec. Relax. Processes* 7:45-49
- Ledieu, J., P. De Ridder, P. De Clerck, and S. Dautrebande. 1986. "A method of measuring soil moisture by time-domain reflectometry," *J. Hydrol.* 88:319-328.
- Or, D., S.B. Jones, J.R. Van Shaar, S. Humphries, and L. Koberstein. 2004. *User's guide WinTDR. Version 6.1. Utah State Univ., Logan.*
- Topp, G.C., J.L. Davis & A.P. Annan. 1980. "Electromagnetic determination of soil water content: measurements in coaxial transmission lines," *Water Resources Research*, v. 16, No. 3:574-582.
- Wang, Z., Y. Kojima, S. Lu, Y. Chen, R. Horton, and R.C. Schwartz. 2014. Time domain reflectometry waveform analysis with second order bounded mean oscillation. *Soil Sci. Soc. Am. J.* 78:1146–1152.
doi:10.2136/sssaj2013.11.0497

Appendix A. Example Program

The following program will work, as written, on a CR1000X, CR1000, CR800-series, or CR6-series data logger. One CS635 TDR probe is connected to channel 1 on an SDM8X50 multiplexer. The CS635 has a 2 m cable and a 3 m window.

CRBasic Example A-1. TDR200 Program Using One CS635 Connected to the SDM8X50

```
'Sample TDR200 program on CR6 data logger
'Example written for 1 CS635 sensor connected to Channel 1 on an SDM8X50 multiplexer
'CS635 has 2 meter cable and a 3 meter window

Public CS635_LaL
Public CS635_VWC
Public CS635_WaveFormValues (1013)

'Topp Equation Dielectric Constants
const a0= -0.053
const a1= 0.0292
const a2= -0.00055
Const a3= 0.0000043

DataTable (TDR_VWC,1,-1)
  Sample (1,CS635_LaL,IEEE4)
  Sample (1,CS635_VWC,IEEE4)
EndTable

DataTable (TDR_Waveform,1,-1)
  Sample (1013,CS635_WaveFormValues(),IEEE4)
EndTable

BeginProg
  Scan (1,Min,0,0)

  TDR200 (CS635_LaL,0,0,1001,4,1.0,1000,2,3,0.3,0.085,1.0,0,60,2,2)
  CS635_VWC = a0 + a1*(CS635_LaL^2) + a2*(CS635_LaL^2)^2 + a3*(CS635_LaL^2)^3
  TDR200 (CS635_WaveFormValues(),0,1,1001,4,1.0,1000,2,3,0.3,0.085,1.0,0,60,2,2)

  CallTable TDR_VWC
  CallTable TDR_Waveform
NextScan
EndProg
```

Appendix B. Calibration Wizard Tutorial

The Calibration Wizard is designed to help users:

- Calibrate TDR probes to eliminate any probe to probe variability
- Create probe-specific lengths and offsets for user-made probes
- Quickly determine the appropriate cable and window lengths of any probe
- Calibrate the electrical conductivity parameters (probe cell constant)

NOTE

Before using the Calibration Wizard, physically connect all multiplexers and sensors the way they will be permanently deployed. This will ensure that the Calibration Wizard determines all measurement parameters correctly.

1. To start the Calibration Wizard, select .

2. Select whether to **Calibrate Probe Length and Probe Offset** only or to also **Calibrate Electrical Conductivity Parameters**. Click **Next**.

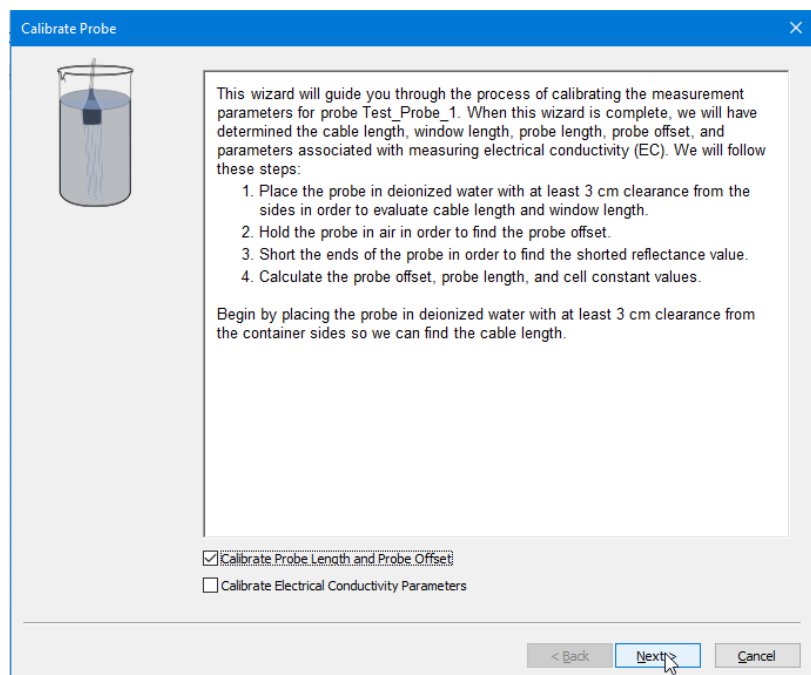

3. Place probe in deionized water with at least 3 cm clearance from the sides and then click on **Next** to determine the appropriate cable length and window length.

- A waveform with a default window length of 50 m is then displayed with *PC-TDR* highlighting where it thinks the probe is found. If the probe is not within the highlighted region, click on the highlighted area in the wizard window and move or scale the region to encompass the entire portion of the probe. If it is difficult to find the probe or the probe was not entirely in water prior to the measurement, select **Refresh** button and measure the probe again. Once the cable and window lengths are satisfactory, click **Next**.

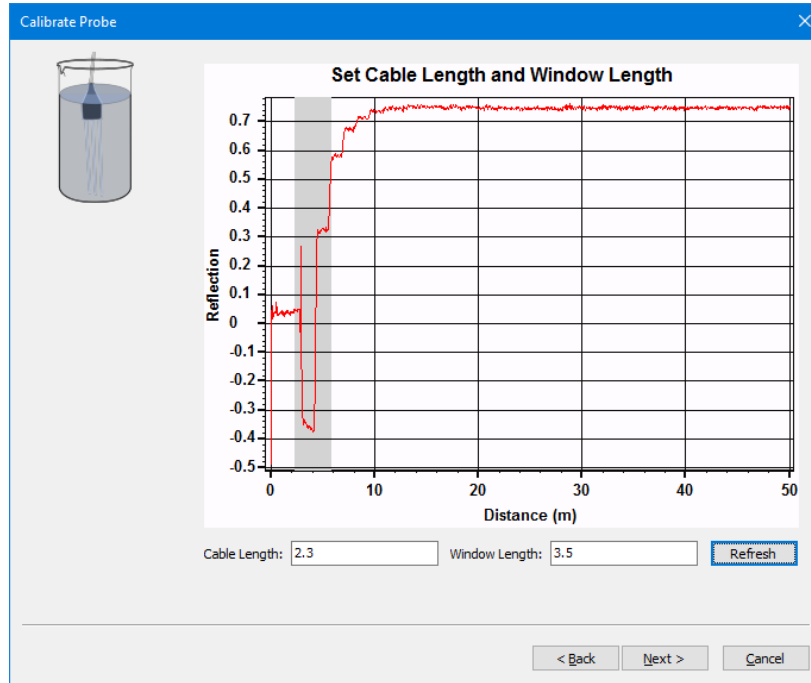

- Enter the temperature of the water and select **Next**.

The screenshot shows the 'Calibrate Probe' window. On the left is the same probe icon. The main area contains a text box with the following text: 'We need to measure the probe when it is submerged in water at a known temperature. Please ensure that the probe's rods are completely submerged. Also enter the temperature of the water in either degrees Celsius or degrees Fahrenheit.' Below the text box is an input field for 'Water Temperature: 21.5' with a dropdown menu set to '°C'. At the bottom of the window are buttons for '< Back', 'Next >', and 'Cancel'.

6. A detailed measurement is performed and the probe start and end are measured. If the probe reflections are not properly found, click **Refresh** and attempt to find the beginning and end again. If the waveform is noisy, increase the number of averages or adjust the filtering level (Section 8.4, *Filtering and Averaging* (p. 19)). If the beginning and ending look sufficient, click **Next**.

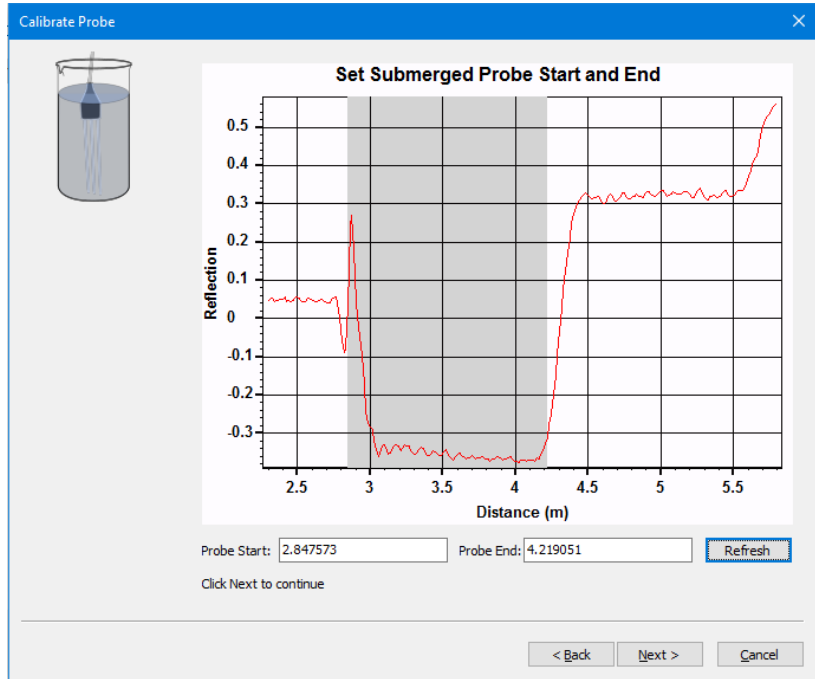

7. Remove the probe from the water and click **Next**.

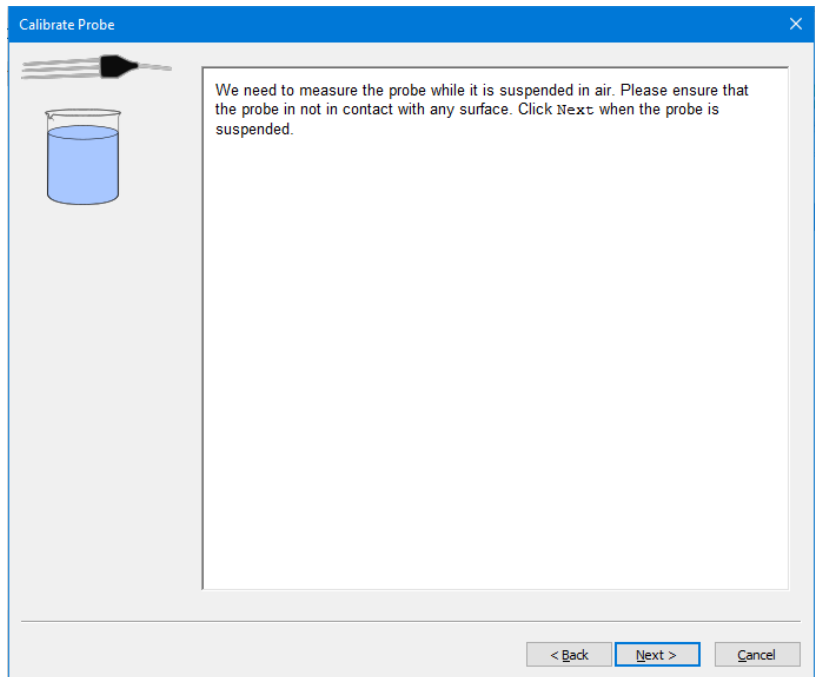

8. The air measurement is now graphed with the beginning and ending of the probe highlighted. If the highlighted region does not properly represent the beginning or end of the probe, either enter new values into the text boxes below the window or use the cursor within the graph window to adjust the width and location of the start and end positions.



9. If electrical conductivity calibration was selected, short the ends of the probes with a conductive material like aluminum foil. Once the ends of the rods are shorted, click **Next**.

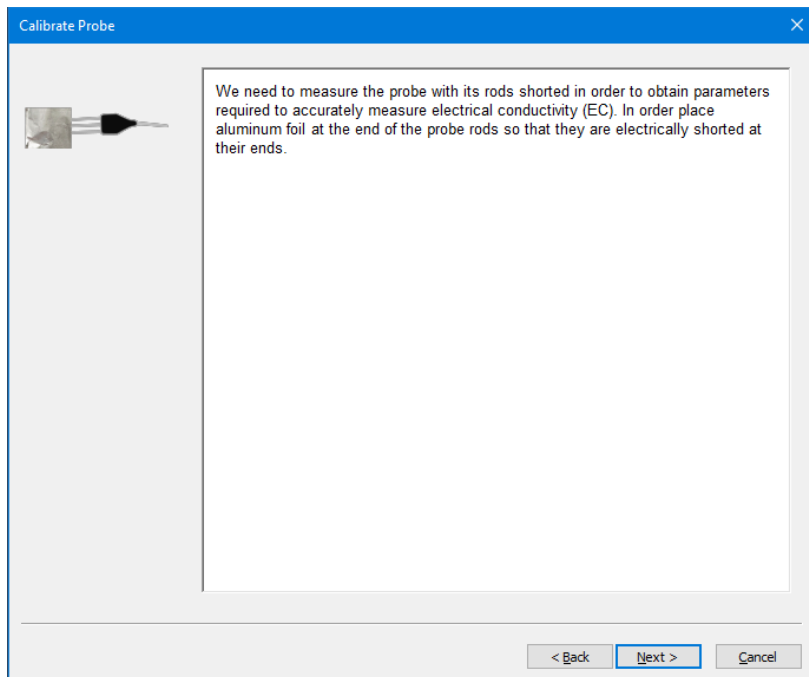

10. After the **Calibration Summary** window is displayed, click **Finish** and the values from the summary will be automatically applied to the probe that was calibrated.

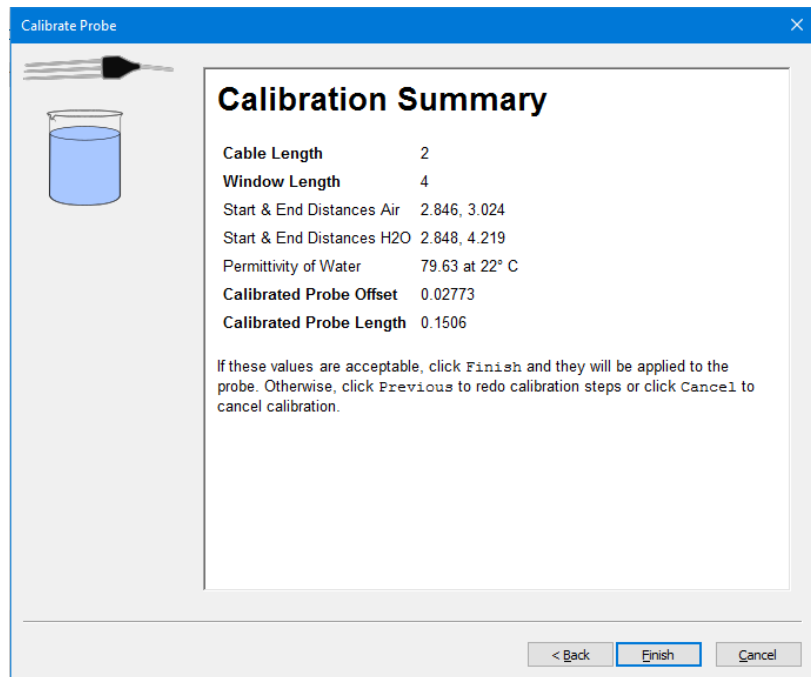

Appendix C. Terminal Commands

The TDR200 was developed to be interfaced as a virtual COM port via its physical built-in USB port and to be controlled using third party or user-created application-specific software. In order to use the virtual COM port feature and control the TDR200, a compatible USB driver needs to be installed on the host machine. The USB driver for Windows is available and can be installed via the PCTDR 3 software. The virtual COM port has the following COM port settings:

115200 baud rate, 8 bit, 1 stop bit, no parity

The TDR200 terminal mode has an ASCII based command set that can be used to control the device. A list of available commands is below and can also be returned by typing **HELP**, **H**, or **?** inside the terminal mode.

The command list:

| | |
|------|--|
| SVP | Set Vp Value |
| SNA | Set Number of Averages |
| SNP | Set Number of Points |
| SDI | Set Distance (Cable Length) |
| SWL | Set Window Length |
| SPL | Set Probe Length |
| SPO | Set Probe Offset |
| SCC | Set Probe Cell Constant |
| SREJ | Set 50/60 Hz Rejection |
| SFIL | Set Filter Level |
| SLAA | Set Length Apparent Algorithm |
| SMUX | Set SDMX50 Channel |
| SDEF | Set Measurement Parameters to Defaults |
| DUMP | Show Measurement Parameters: Vp, Number of Averages, Number of Points, Distance, Window Length, Probe Length, Probe Offset, Probe Cell Constant, 50/60 Hz Rejection, Filter Level, Length Apparent Algorithm |
| GLCO | Return previously calculated Electrical Conductivity value |
| GCO | Acquire a new Waveform and return Electrical Conductivity value |
| GDE | Get the Derivative of the last Waveform acquired |
| GDRV | Acquire a new Waveform and return its Derivative |
| GLMO | Get Water Content value from the last Waveform acquired |
| GMO | Acquire a new Waveform and return Water Content value |
| GVER | Get Operating System Version |

| | |
|------|--|
| GSIG | Get ROM Signature |
| GVAR | Get Variables (Return First Peak and Second Reflection from previous WC calculation) |
| GWA | Acquire and return a Waveform |
| RSU | Retrieve Current Setup from Flash and Configure Device |
| SSU | Save Current Setup to Flash |
| H | Help |

C.1 About Notation Used in this Document

To describe the format of commands and responses, [space] is used to denote a space character (hex 0x20), \r is used to indicate a carriage return (CR), and \n is used to indicate a line feed (LF). Also, other variable text such as the command, command parameters, or variable responses from the TDR200 are enclosed in square brackets (e.g., [command] or [value]).

C.2 Commands Requiring a Parameter

The commands SVP, SNA, SNP, SDI, SWL, SPL, SPO, SCC, SREJ, SFIL, SLAA, and SMUX require a parameter. For these commands, usage is of this form:

[Command][space][ASCII parameter]\r\n. For example, “SPL 0.3\r\n” will set the probe length to 0.3.

Typing any of these commands without a parameter returns a help message displaying usage requirements.

Responses to these commands begin with a CR and LF and the response to the command follows.

C.3 Commands Without a Parameter

The commands SDEF, DUMP, GLCO, GCO, GDE, GDRV, GLMO, GMO, GVER, GSIG, GVAR, GWA, RSU, and SSU do not require a parameter. For these commands, usage is of this form:

[Command]\r\n. For example, to return the current version of the TDR200 operating system the command is “GVER\r\n”

Responses to these commands begin with a CR and LF and the response to the command follows.

C.4 Responses

There are three types of responses: Error Response, ACK Response, and Value Response.

C.4.1 Error Response

Error responses begin with a CR and LF and are of the form: `\r\nError: [error]`. For example, “`\r\nError: Initialization in progress`”

Possible errors:

- Initialization in Progress – returned when a command is received while the TDR200 is going through initialization.
- Measurement in Progress – returned when a command is received while the TDR200 is performing a measurement.
- Command Not Recognized – returned when the command given is not recognized by the TDR200.
- Value out of Range – returned when the input parameter is out of range.
- Undefined Value – returned when there is an error in the input parameter.
- Initialization Failed – returned if the TDR200 initialization failed.
- Unknown Internal

C.4.2 Ack Response

Ack responses are returned by the sensor in response to commands that set a parameter in the device. Ack responses begin with a CR and LF and are of the form: `\r\n>[space][command]`. For example, the response to `SPL 0.3\r\n` is “`\r\n> SPL`”. Refer to Appendix C.5, *Command Usage and Responses* (p. C-3), for specifics on the responses to each command.

C.4.3 Value Response

Value responses are returned by the sensor in response to commands that ask for a value or set of values from the device. Value responses begin with a CR and LF and vary based on the command. Refer to Appendix C.5, *Command Usage and Responses* (p. C-3), for specifics on the responses to each command.

C.5 Command Usage and Responses

SVP – Set Vp Value

Usage: `SVP[space][value]\r\n` – range of value = [0.10 – 1.0]
Response: `\r\n>[space]SVP`

SNA – Set Number of Averages

Usage: `SNA[space][value]\r\n` – range of value = [1 – 128]
Response: `\r\n>[space]SNA`

SNP – Set Number of Points

Usage: `SNP[space][value]\r\n` – range of value = [20 – 10112]
Response: `\r\n>[space]SNP`

SDI – Set Distance

Usage: SDI[space][value]\r\n – range of value = [-2.0 – 3822.0]
 Response: \r\n>[space]SDI

SWL – Set Window Length

Usage: SWL[space][value]\r\n – range of value = [0.0 – 3824.0]
 Response: \r\n>[space]SWL

SPL – Set Probe Length

Usage: SPL[space][value]\r\n – range of value = [0.0 – 10.0]
 Response: \r\n>[space]SPL

SPO – Set Probe Offset

Usage: SPO[space][value]\r\n – range of value = [0.0 – 0.50]
 Response: \r\n>[space]SPO

SCC – Set Probe Cell Constant

Usage: SCC[space][value]\r\n
 Response: \r\n>[space]SCC

SREJ – Set 50/60 Hz Rejection

Usage: SREJ[space][value]\r\n – range of value = [0,50,60]
 Response: \r\n>[space]SREJ

SFIL – Set Filter Level

Usage: SFIL[space][value]\r\n – range of value = [0 – 10]
 Response: \r\n>[space]SFIL

SLAA – Set Length Apparent Algorithm

Usage: SLAA[space][value]\r\n – range of value = [0 - 2]
 Response: \r\n>[space]SLAA

SMUX – Set SDMX50 channel

Usage: SMUX[space][value]\r\n – value = (address[1 to 15]*10) +
 channel[1 to 8]

Response: \r\n>[space]SMUX

SDEF – Set Measurement Parameters to Defaults

Usage: SDEF\r\n

Response:

\r\nSetup has been configured as follows:

\r\n Vp = [vp value]

\r\n Ave = [number of averages value]

\r\n Points = [number of points value]

\r\n Distance (Cable Length) = [cable length value]

\r\n Window Length = [window length value]

\r\n Probe Length = [probe length value]

\r\n Probe Offset = [probe offset value]

\r\n Probe Cell Constant = [probe cell constant value]

\r\n 50/60 Hz Rejection = [rejection Hz value]

\r\n Filter Level = [filter level value]

\r\n Length Apparent Algorithm = [LAA value]

NOTE

Each line containing a value has an appropriate number of space characters to ensure that 26 total characters are between the ‘\n’ character and the ‘=’ character.

DUMP – Show Measurement Parameters:

Usage: DUMP\r\n

Response:

\r\nSetup has been configured as follows:

\r\n Vp = [vp value]

\r\n Ave = [number of averages value]

\r\n Points = [number of points value]

\r\n Distance (Cable Length) = [cable length value]

\r\n Window Length = [window length value]

\r\n Probe Length = [probe length value]

\r\n Probe Offset = [probe offset value]

\r\n Probe Cell Constant = [probe cell constant value]

\r\n 50/60 Hz Rejection = [rejection Hz value]

\r\n Filter Level = [filter level value]

\r\n Length Apparent Algorithm = [LAA value]

NOTE

Each line containing a value has an appropriate number of space characters to ensure that 26 total characters are between the '\n' character and the '=' character.

GLCO – Return previously calculated Electrical Conductivity value

Usage: GLCO\r\n

Response: \r\n[f.ffff] – where f.ffff is an ASCII representation of a floating point value (4 decimal places)

GCO – Acquire a new Waveform and return Electrical Conductivity value

Usage: GCO\r\n

Response: \r\n[f.ffff] – where f.ffff is an ASCII representation of a floating point value (4 decimal places)

GDE – Get the Derivative of the last Waveform acquired

Usage: GDE\r\n

Response: \r\n[NNNN],[space][f.ffff]

\r\n[NNNN],[space][f.ffff]

\r\n[NNNN],[space][f.ffff]

etc.

where NNNN is the 4 digit width point number and f.ffff is an ASCII representation of the associated floating point value (4 decimal places)

GDRV – Acquire a new Waveform and return its Derivative

Usage: GDRV\r\n

Response: \r\n[NNNN],[space][f.ffff]

\r\n[NNNN],[space][f.ffff]

\r\n[NNNN],[space][f.ffff]

etc.

where NNNN is the 4 digit width point number and f.ffff is an ASCII representation of the associated floating point value (4 decimal places)

GLMO – Get water Content value from the last Waveform acquired

Usage: GLMO\r\n

Response: \r\n[f.ffff] – where f.ffff is an ASCII representation of a floating point value (4 decimal places)

GMO – Acquire a new Waveform and return Water Content Value

Usage: GMO\r\n

Response: \r\n[f.ffff] – where f.ffff is an ASCII representation of a floating point value (4 decimal places)

GVER – Get Operating System Version

Usage: GVER\r\n

Response: \r\n[version] – where version is the current version of the operating system

GSIG – Get ROM Signature

Usage: GSIG\r\n

Response: \r\nRom Signature:[space][sig] – where sig is the hex representation of the OS signature

GVAR – Get Variables (Return First Peak and Second Reflection from previous WC calculation)

Usage: GVAR\r\n

Response: \r\n[f.ffff]
\r\n[f.ffff]

where the first f.ffff returned is an ASCII representation of the value of the first peak (in meters) and the second f.ffff returned is an ASCII representation of the value of the second reflection (in meters)

GWA – Acquire and return a Waveform

Usage: GWA\r\n

Response: \r\n[NNNN],[space][f.ffff]
\r\n[NNNN],[space][f.ffff]
\r\n[NNNN],[space][f.ffff]
etc.

where NNNN is the 4-digit width point number and f.ffff is an ASCII representation of the associated floating point value (4 decimal places)

RSU – Retrieve Current Setup from Flash and Configure Device

Usage: RSU\r\n

Response:

\r\nSetup has been configured from flash as follows:

\r\n Vp = [vp value]

\r\n Ave = [number of averages value]

\r\n Points = [number of points value]

\r\n Distance (Cable Length) = [cable length value]

\r\n Window Length = [window length value]

\r\n Probe Length = [probe length value]

\r\n Probe Offset = [probe offset value]

\r\n Probe Cell Constant = [probe cell constant value]

\r\n 50/60 Hz Rejection = [rejection Hz value]

\r\n Filter Level = [filter level value]

\r\n Length Apparent Algorithm = [LAA value]

NOTE

Each line containing a value has an appropriate number of space characters to ensure that 26 total characters are between the ‘\n’ character and the ‘=’ character.

SSU – Save Current Setup to Flash

Usage: SSU\r\n

Response: \r\nSetup has been saved to Flash.

Global Sales & Support Network

A worldwide network to help meet your needs



Australia

Location: Garbutt, QLD Australia
Phone: 61.7.4401.7700
Email: info@campbellsci.com.au
Website: www.campbellsci.com.au

Brazil

Location: São Paulo, SP Brazil
Phone: 11.3732.3399
Email: vendas@campbellsci.com.br
Website: www.campbellsci.com.br

Canada

Location: Edmonton, AB Canada
Phone: 780.454.2505
Email: dataloggers@campbellsci.ca
Website: www.campbellsci.ca

China

Location: Beijing, P. R. China
Phone: 86.10.6561.0080
Email: info@campbellsci.com.cn
Website: www.campbellsci.com

Costa Rica

Location: San Pedro, Costa Rica
Phone: 506.2280.1564
Email: info@campbellsci.cc
Website: www.campbellsci.cc

France

Location: Vincennes, France
Phone: 0033.0.1.56.45.15.20
Email: info@campbellsci.fr
Website: www.campbellsci.fr

Germany

Location: Bremen, Germany
Phone: 49.0.421.460974.0
Email: info@campbellsci.de
Website: www.campbellsci.de

South Africa

Location: Stellenbosch, South Africa
Phone: 27.21.8809960
Email: sales@campbellsci.co.za
Website: www.campbellsci.co.za

Southeast Asia

Location: Bangkok, Thailand
Phone: 66.2.719.3399
Email: thitipongc@campbellsci.asia
Website: www.campbellsci.asia

Spain

Location: Barcelona, Spain
Phone: 34.93.2323938
Email: info@campbellsci.es
Website: www.campbellsci.es

UK

Location: Shephed, Loughborough, UK
Phone: 44.0.1509.601141
Email: sales@campbellsci.co.uk
Website: www.campbellsci.co.uk

USA

Location: Logan, UT USA
Phone: 435.227.9120
Email: info@campbellsci.com
Website: www.campbellsci.com