

INSTRUCTION MANUAL

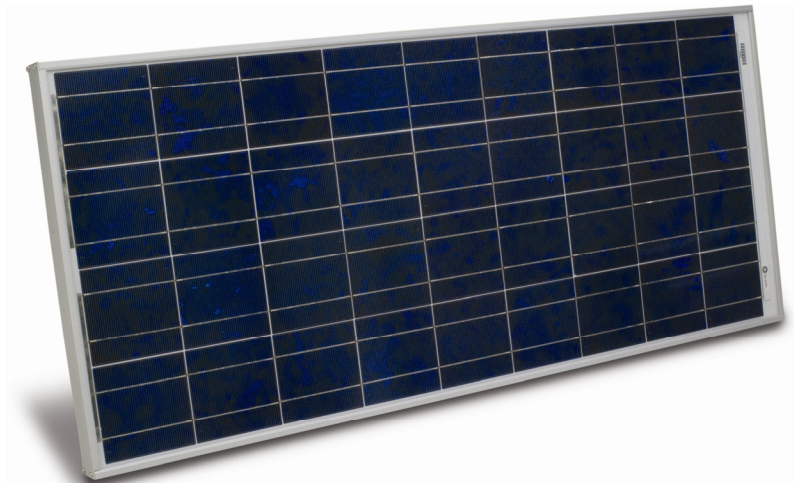

SP70 Solar Panel

Revision: 3/09



Copyright © 1987-2009
Campbell Scientific, Inc.

Warranty and Assistance

The **SP70 SOLAR PANEL** is warranted by CAMPBELL SCIENTIFIC, INC. to be free from defects in materials and workmanship under normal use and service for twelve (12) months from date of shipment unless specified otherwise. Batteries have no warranty. CAMPBELL SCIENTIFIC, INC.'s obligation under this warranty is limited to repairing or replacing (at CAMPBELL SCIENTIFIC, INC.'s option) defective products. The customer shall assume all costs of removing, reinstalling, and shipping defective products to CAMPBELL SCIENTIFIC, INC. CAMPBELL SCIENTIFIC, INC. will return such products by surface carrier prepaid. This warranty shall not apply to any CAMPBELL SCIENTIFIC, INC. products which have been subjected to modification, misuse, neglect, accidents of nature, or shipping damage. This warranty is in lieu of all other warranties, expressed or implied, including warranties of merchantability or fitness for a particular purpose. CAMPBELL SCIENTIFIC, INC. is not liable for special, indirect, incidental, or consequential damages.

Products may not be returned without prior authorization. The following contact information is for US and International customers residing in countries served by Campbell Scientific, Inc. directly. Affiliate companies handle repairs for customers within their territories. Please visit www.campbellsci.com to determine which Campbell Scientific company serves your country. To obtain a Returned Materials Authorization (RMA), contact CAMPBELL SCIENTIFIC, INC., phone (435) 753-2342. After an applications engineer determines the nature of the problem, an RMA number will be issued. Please write this number clearly on the outside of the shipping container. CAMPBELL SCIENTIFIC's shipping address is:

CAMPBELL SCIENTIFIC, INC.

RMA# _____

815 West 1800 North

Logan, Utah 84321-1784

CAMPBELL SCIENTIFIC, INC. does not accept collect calls.

SP70 Table of Contents

PDF viewers note: These page numbers refer to the printed version of this document. Use the Adobe Acrobat® bookmarks tab for links to specific sections.

| | |
|--|-----------|
| 1. General | 1 |
| 2. Specifications | 1 |
| 3. Installation | 2 |
| 3.1 Parts List | 2 |
| 3.2 Mounting | 4 |
| 3.3 Orientation | 11 |
| 3.4 Installation of Morningstar SunSaver SS-10-12V Regulator | 13 |
| 4. Maintenance | 14 |
| 5. Power Considerations | 15 |
| 5.1 Proper Solar Power and Lead Acid Battery Sizes | 15 |
| 5.2 Voltage Regulator | 15 |

Figures

| | |
|--|----|
| 1. 70 Watt Solar Panel with 20 ft 16 AWG Cable | 2 |
| 2. Mounting Hardware Included with SP70 | 3 |
| 3. Mounting Parts for SP70 | 3 |
| 4. Attach the Arm Brackets to the Back of the Solar Panel | 5 |
| 5. Use Appropriate Lock Washers and Flat Washers to Mount the Arm Brackets to the Solar Panel | 5 |
| 6. Right and Left Arm Brackets are Attached to the Back of the Solar Panel | 6 |
| 7. Attach the Mount to the Back of the Solar Panel between Right and Left Arm Brackets | 6 |
| 8. Use appropriate lock washers and flat washers. Two flat washers are used for each Hex bolt. | 7 |
| 9. Two 5/16-18 x 2.0 U-Bolts are Used for Pole or Tripod Mounting | 7 |
| 10. Lock Washers and Flat Washers are Used to Secure the Two 5/16-18 x 2.0 U-Bolts to the Solar Panel Mount | 8 |
| 11. SP70 Solar Panel is Ready for Pole or Tripod Mounting | 8 |
| 12. SP70 is Mounted to a Pole Using Two 5/16-18 x 2.0 U-Bolts | 9 |
| 13. SP70 Solar Panel is Mounted on a Tripod | 9 |
| 14. Two 5/16-18 x 1.5 U-Bolts are Attached to Each Side of the Solar Panel Mount for Tower Mounting | 10 |
| 15. Backside View of Figure 14 | 10 |
| 16. Angle Settings on Right and Left Arm Brackets | 12 |
| 17. Morningstar's SunSaver SS-10-12V Regulator Mounted on an Enclosure Backplate | 14 |

18. Battery Terminal Strip Adapters for Power Connection to External Battery..... 14

Tables

1. SP70 Parts List..... 4
2. Solar Panel Tilt Angle* 11
3. Configurations for Desired Angles 11

SP70 Solar Panel

1. General

Solar panels are a photovoltaic power source used for providing power to the system, as well as charging lead acid batteries. The SP70 solar panel is supplied with a 20 ft long, 16 AWG cable with two leads terminated with spade lugs. This cable connects to the external voltage regulator. The voltage regulator is not supplied with the SP70 solar panels, and must be purchased separately. The SunSaver SS-10-12V voltage regulator (CSI p/n 18529) is recommended for use with SP70 solar panels, and it can be purchased from Campbell Scientific, Inc. The PS100 or CH100 can not be used with SP70 solar panels.

2. Specifications

SP70 Solar Panel

| | |
|--|--------------------------------------|
| Typical peak power (Pp): | 70 W |
| Voltage at peak power (Vpp): (voltage from solar panel before regulator) | 17.1 V |
| Current at peak power (Ipp): | 4.1 A |
| Guaranteed minimum peak power: | 66.5 W |
| Temperature coefficient of power: | $-(0.5 \pm 0.05)\%/^{\circ}\text{C}$ |
| Length: | 120.9 cm (47.6") |
| Width: | 53.7 cm (21.1") |
| Depth: | 5.0 cm (1.97") |
| Weight: | 7.7 kg (17.0 lbs.) |

NOTE

The above solar panel characteristics assume a 1 kilowatt per square meter illumination and a solar panel temperature of 25°C. Individual panels may vary up to 10%. The output panel voltage increases as the panel temperature decreases.

Wind Load

| | |
|--------------------|-----------------|
| Single SP70 panel: | 31 m/s (70 mph) |
| Double SP70 panel: | 24 m/s (55 mph) |

NOTE

The above wind load data assumes that the SP70 solar panel is mounted on a CM110 tripod with extended guy wire kit (CSI p/n 19282) installed with the guy radius of 100 inches and the 100 pounds of guy wire pretension. The position of the solar panel along the tripod mast has little effect on the wind load. However, if the extended guy wire kit is not installed, the wind load is reduced to 11 m/s (25 mph) and 8.9 m/s (20 mph) for single and double panel installations, respectively. For more information on installing the CM110 tripod with proper guy wire pretension, please refer to the CM110 manual.

Regulator (purchased separately and not shipped with SP70)

| | |
|-----------------------------------|--------------------------------|
| Model: | Morningstar SunSaver SS-10-12V |
| Temperature Compensation (mV/°C): | -28 |
| Self Consumption: | 6 to 10 mA |
| Operating Temperature: | -40° to +85°C |

NOTE

A second SP70 can be connected to the regulator to provide a total of 140 W of typical peak power. One Morningstar SunSaver SS-10-12V regulator can handle two SP70 solar panels.

3. Installation

3.1 Parts List

The SP70 solar panel ships with two items: one 70 watt solar panel and one mounting hardware package. The solar panel has 20 ft long 16 AWG wire built in the back the panel as shown in Figure 1. The mounting hardware package contains the mounting brackets and other parts necessary to mount the solar panel to a tripod or tower as shown in Figure 2.

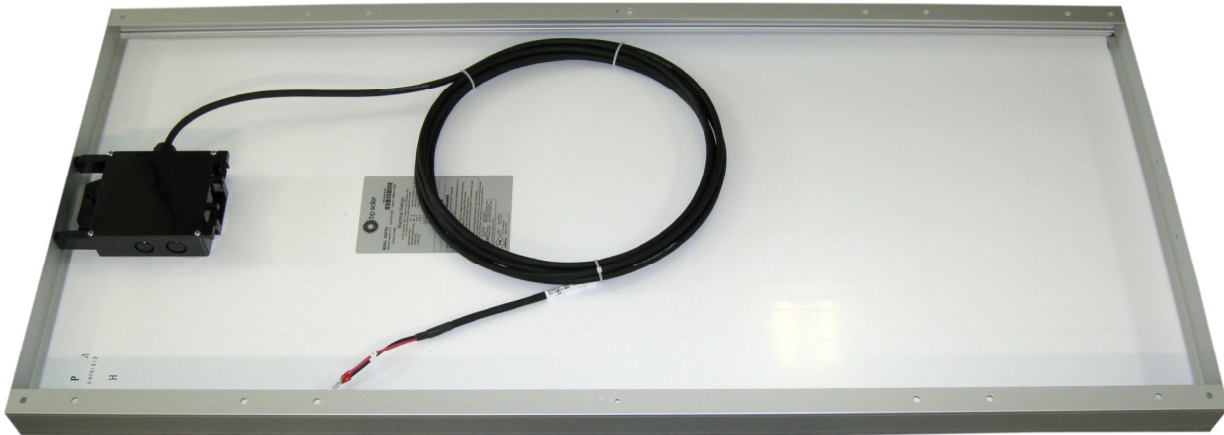

FIGURE 1. 70 Watt Solar Panel with 20 ft 16 AWG Cable



FIGURE 2. Mounting Hardware Included with SP70

The Table 1 and Figure 3 show the list of parts included in the mounting hardware package.

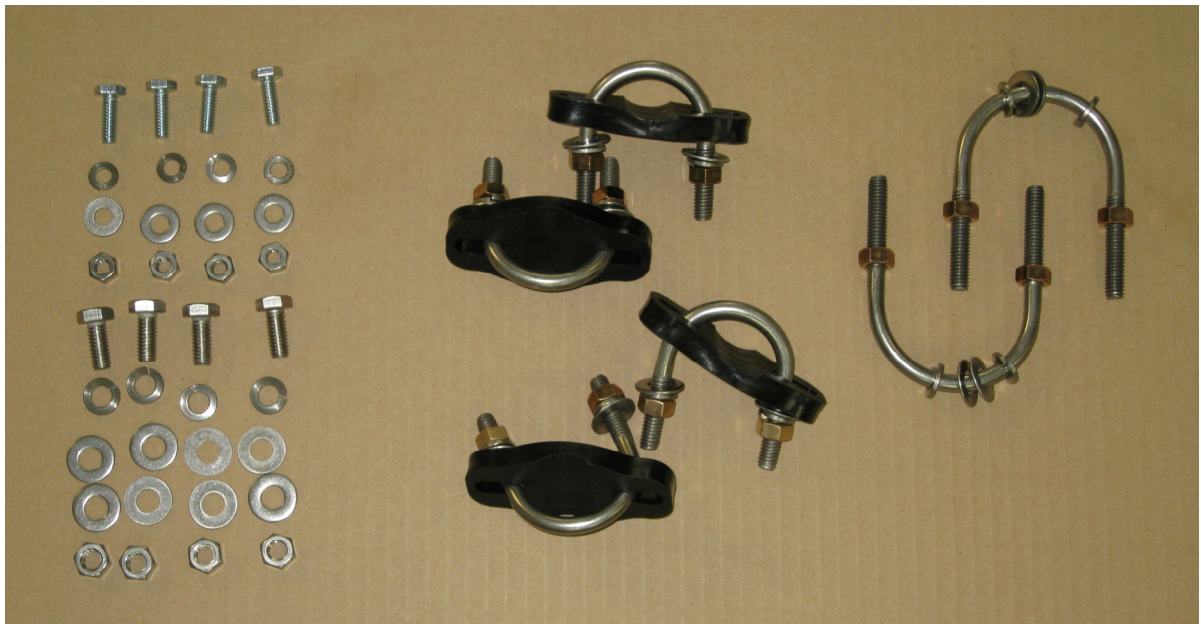

FIGURE 3. Mounting Parts for SP70

| TABLE 1. SP70 Parts List | | |
|---------------------------------|---|------------|
| Item # | Description | Qty |
| 1 | 70 W Solar Panel | 1 |
| 2 | Right Arm Bracket | 1 |
| 3 | Left Arm Bracket | 1 |
| 4 | Mount | 1 |
| 5 | 5/16-18 x 1.5 U-Bolt with lock washers, flat washers, nuts | 4 |
| 6 | 5/16-18 x 2.0 U-Bolt with lock washers, flat washers, nuts | 2 |
| 7 | 1/4-20 x 0.75 Hex bolt | 4 |
| 8 | 1/4-20 Nut | 4 |
| 9 | Locke washer | 4 |
| 10 | Flat washer | 4 |
| 11 | 5/16-18 x 0.75 Hex bolt | 4 |
| 12 | 5/16-18 Nut | 4 |
| 13 | Lock washer | 4 |
| 14 | Flat washer | 8 |

3.2 Mounting

The SP70 solar panel ships with mounting brackets. These brackets can be found in the mounting hardware package. Remove the right and left arm brackets, as well as the mount from the package. Attach the right and left arm brackets, using 1/4-20 x 0.75 Hex bolt and nuts as shown in Figure 4. Use the matching lock washers and flat washers as shown in Figure 5.

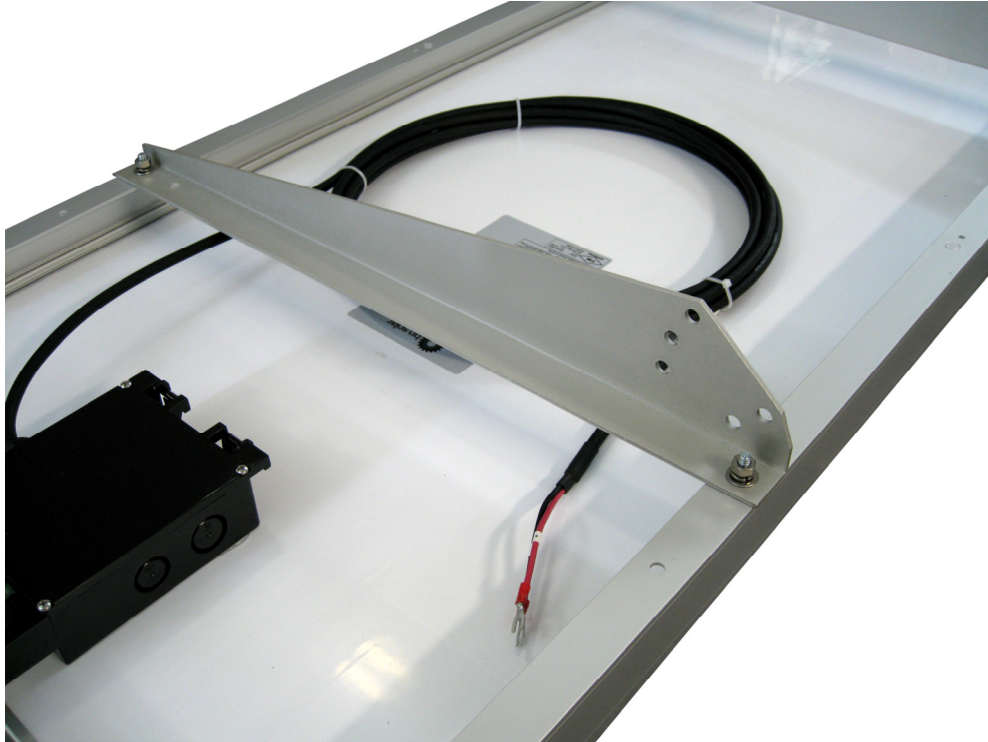

FIGURE 4. Attach the Arm Brackets to the Back of the Solar Panel

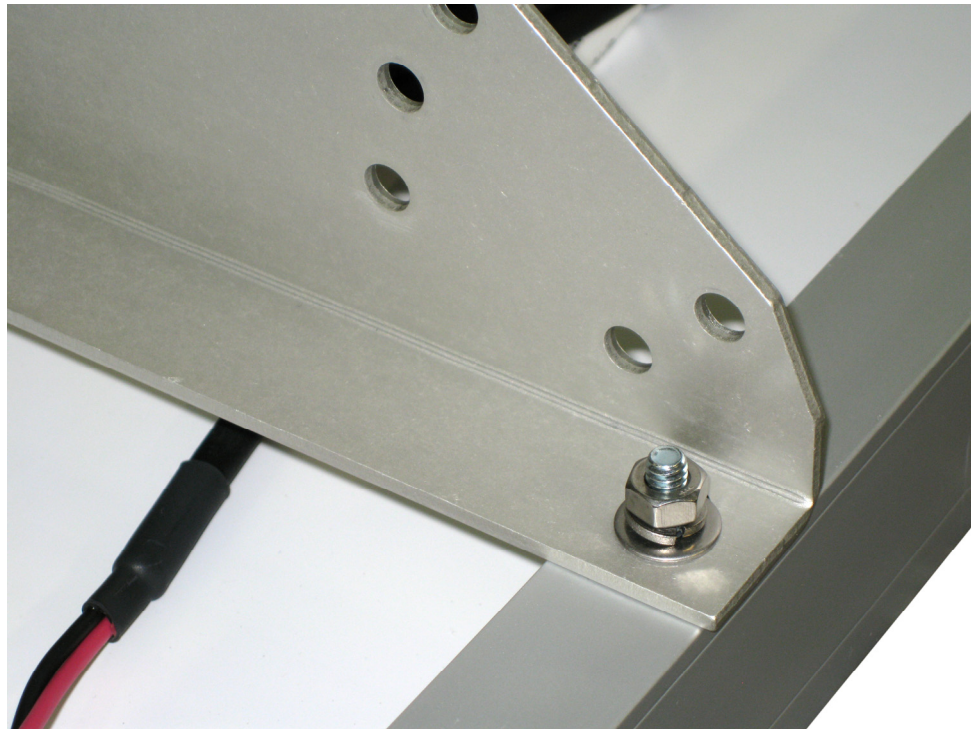

FIGURE 5. Use Appropriate Lock Washers and Flat Washers to Mount the Arm Brackets to the Solar Panel



FIGURE 6. Right and Left Arm Brackets are Attached to the Back of the Solar Panel

Attach the mount to the back of the solar panel between the right and left brackets already in place as shown in Figure 7. Use the 5/16-18 x 0.75 Hex bolt and nuts along with the matching lock washers and flat washers. Use two flat washers for each bolt as shown in Figure 8.

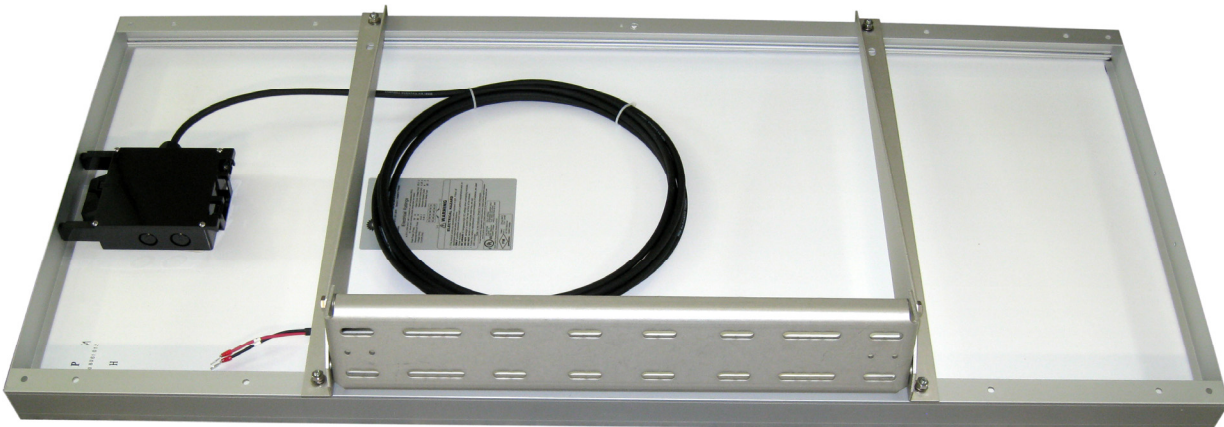

FIGURE 7. Attach the Mount to the Back of the Solar Panel between Right and Left Arm Brackets

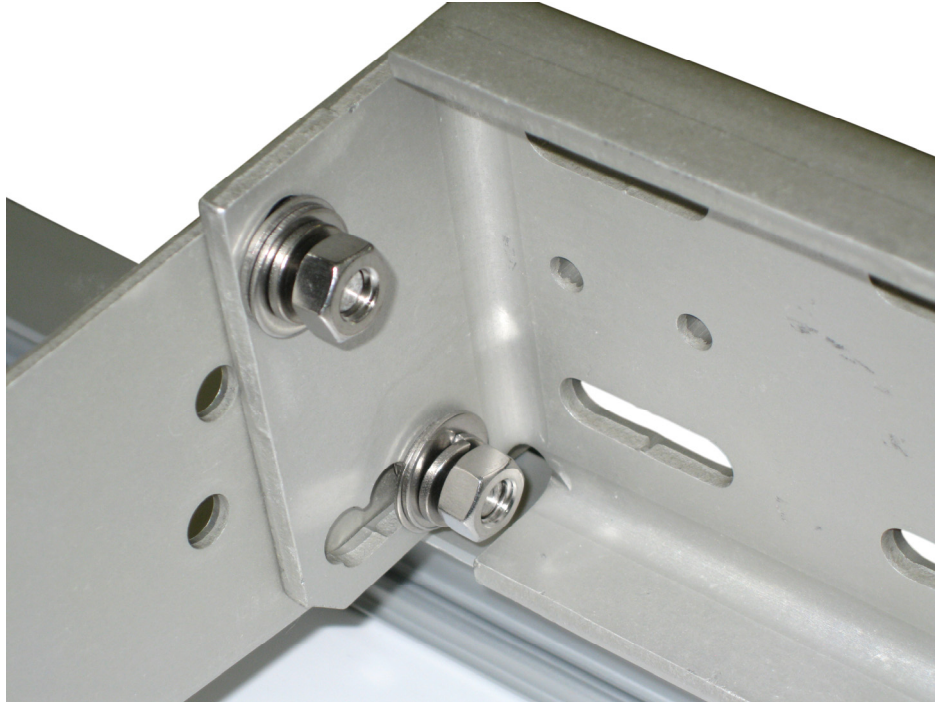

FIGURE 8. Use appropriate lock washers and flat washers. Two flat washers are used for each Hex bolt.

For pole or tripod mounting, use the two 5/16-18 x 2.0 U-Bolts included in the package as shown in Figures 9, 10, and 11.



FIGURE 9. Two 5/16-18 x 2.0 U-Bolts are Used for Pole or Tripod Mounting



FIGURE 10. Lock Washers and Flat Washers are Used to Secure the Two 5/16-18 x 2.0 U-Bolts to the Solar Panel Mount



FIGURE 11. SP70 Solar Panel is Ready for Pole or Tripod Mounting

The panel should be mounted facing south if located in the Northern Hemisphere, or facing north in the Southern Hemisphere. The nuts fastening the solar panel mount to the pole or the tripod mast should be as tight as possible without bending the mount. See Figures 12 and 13.



FIGURE 12. SP70 is Mounted to a Pole Using Two 5/16-18 x 2.0 U-Bolts



FIGURE 13. SP70 Solar Panel is Mounted on a Tripod

Alternatively, you can use four 5/16-18 x 1.5 U-Bolts to mount the SP70 solar panels to a tower. Select the appropriate sets of holes in the mount to match the width of the tower. See Figures 14 and 15.



FIGURE 14. Two 5/16-18 x 1.5 U-Bolts are Attached to Each Side of the Solar Panel Mount for Tower Mounting

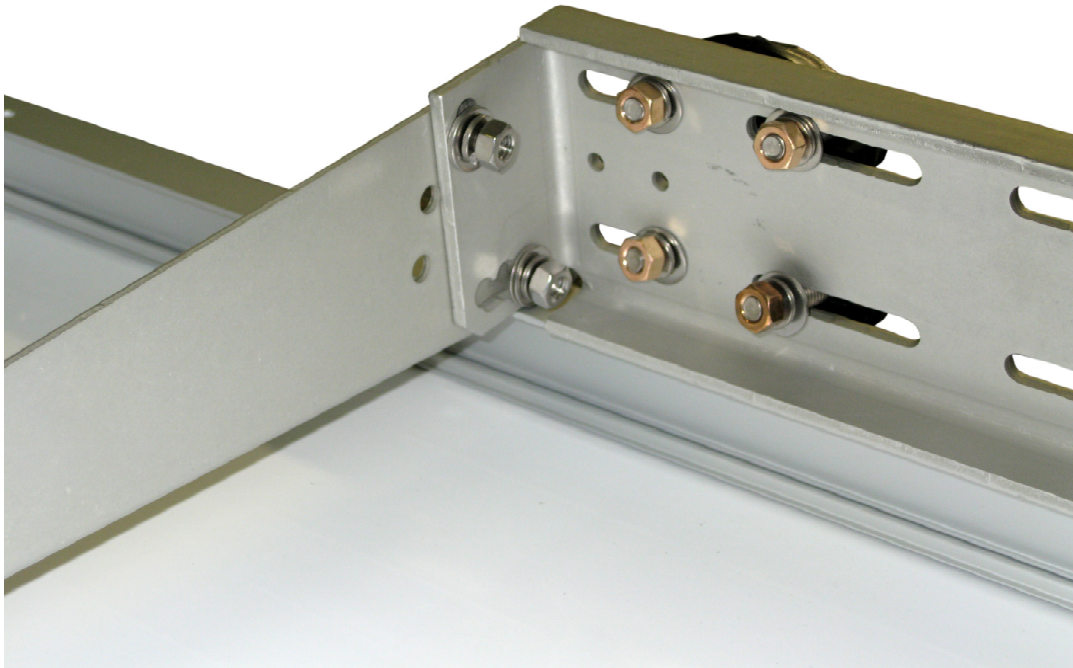

FIGURE 15. Backside View of Figure 14

3.3 Orientation

The solar panel should be oriented to receive maximum insolation (incident solar radiation) over the course of a year. Suggested tilt angles of the solar panel are given in Table 2.

After determining the tilt angle, loosen the 5/16" nuts on each side of the solar panel, and reposition the Hex bolt locations according to the hole location settings shown in Table 3 to adjust the panel. Tighten the two nuts to secure the position. See Figure 16.

TABLE 2. Solar Panel Tilt Angle*

| <u>Site Latitude (N or S)</u> | <u>Tilt Angle</u> |
|-------------------------------|-------------------|
| 0 – 10° | 10° |
| 11 – 20° | Latitude +5° |
| 21 – 45 | Latitude +10° |
| 46 – 65 | Latitude +15° |
| > 65 | 80° |

* From "Design Aids for Small PV Power Systems", Solorex Corp.

TABLE 3. Configurations for Desired Angles

| Hole Locations | Angle |
|--|--------------|
| Holes P and A Aligned with Holes 1 and Y | 90 |
| Holes P and A Aligned with Holes 1 and Z | 80 |
| Holes P and B Aligned with Holes 1 and Y | 70 |
| Holes P and B Aligned with Holes 1 and Z | 60 |
| Holes P and C Aligned with Holes 1 and Y | 50 |
| Holes P and C Aligned with Holes 1 and Z | 40 |
| Holes P and C Aligned with Holes 2 and Y | 30 |
| Holes P and C Aligned with Holes 2 and Z | 20 |

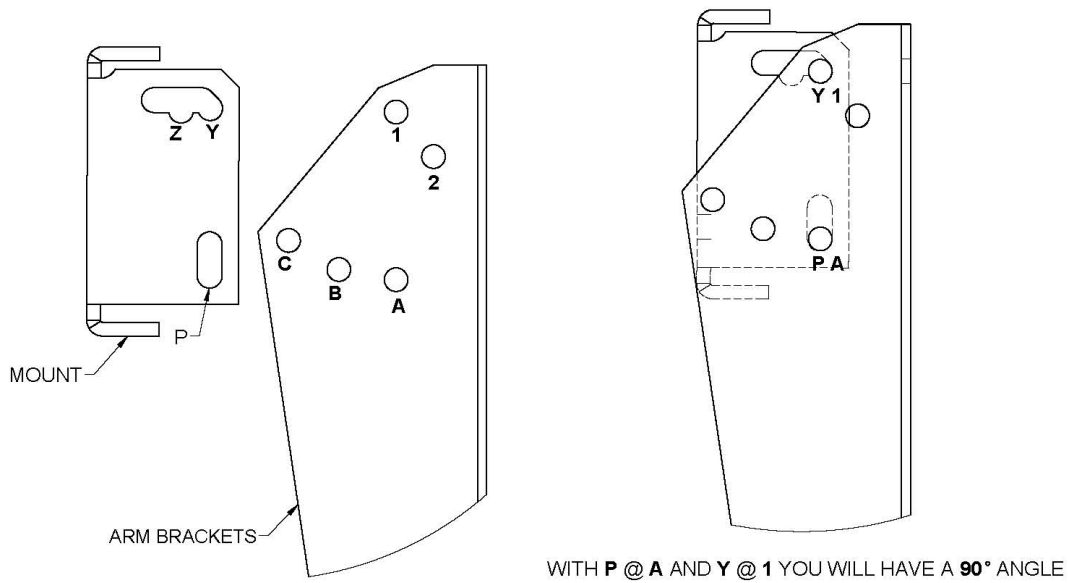

FIGURE 16. Angle Settings on Right and Left Arm Brackets

3.4 Installation of Morningstar SunSaver SS-10-12V Regulator

NOTE For safety reasons, completely cover the solar panel to limit output current and voltage. If nothing is available to cover the panel, be careful not to short solar panel (+) and (-) leads together.

1. Using the supplied mounting hardware, install the Morningstar SunSaver SS-10-12V regulator (CSI p/n 18529) on the mounting plate of an environmental enclosure (see Figure 17).
2. If using deep cycle marine battery along with the SP70 solar panels, install Battery Terminal Strip Adapters (CSI p/n 4386) to each terminal of the user-supplied deep cycle battery as shown in Figure 18.
3. Using the supplied red and black power cables, secure the black wire to terminal lug#1 marked battery (-) on the regulator. Connect the pigtailed end of the black cable to the Battery Terminal Strip Adapter installed on the battery's negative terminal. Secure the red wire to terminal lug #2 marked battery (+) on the regulator. Connect the pigtailed end of the red cable to the Battery Terminal Strip Adapter installed on the battery's positive terminal. With the battery connected and no solar panel input, the green LED on the regulator marked CHARGING **SHOULD NOT** be on.
4. Connect the black (-) wire from the SP70 power cable to terminal lug #3 marked solar (-) on the regulator. Connect the red (+) wire from the SP70 power cable to terminal lug #4 marked solar (+) on the regulator. If using a sealed rechargeable battery, such as our BP24, then verify that the metal **jumper is installed** to configure the regulator to recharge sealed rechargeable batteries (see Figure 17). If using a flooded battery (e.g., deep cycle marine battery), then **remove the jumper**. Also note that no connections are made on the load terminals of the regulator for this application (see Figure 17).
5. If charge current is available from the solar panel, the green LED on the regulator marked CHARGING **WILL LIGHT UP**. This will verify proper operation and wiring of the regulator.
6. To supply power to the system, connect the power leads from Dataloggers and sensors to Terminal Strip Adapters installed on the battery terminals, positive leads to positive terminal, and negative leads to negative terminal of the battery.

NOTE The Morningstar SunSaver SS-10-12V regulator is shipped with the jumper **INSTALLED**. If you are using flooded batteries, such as deep cycle marine battery, **REMOVE** the jumper before installing the regulator.



FIGURE 17. Morningstar's SunSaver SS-10-12V Regulator Mounted on an Enclosure Backplate

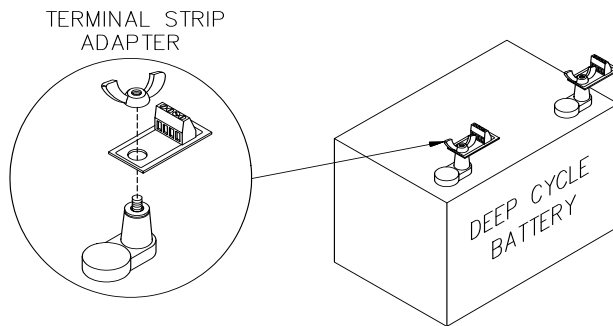

FIGURE 18. Battery Terminal Strip Adapters for Power Connection to External Battery

4. Maintenance

An occasional cleaning of the glass improves the solar panel's efficiency. If a problem with the solar panel is suspected, the panel may be checked by measuring the voltage output. Check the voltage with a voltmeter connected between the two leads of the solar panel. There must be solar radiation incident on the panel and there must be a load connected to the solar panel. The load can be the datalogger, other equipment, or a 75 ohm resistor capable of dissipating solar panel power between the two leads. No voltage output implies a bad solar panel, regulator, or cable. The magnitude of the voltage output depends on the incident solar radiation.

For help in troubleshooting the solar panels, please contact Campbell Scientific, Inc. Applications Engineers.

5. Power Considerations

5.1 Proper Solar Power and Lead Acid Battery Sizes

The solar panel converts light energy to electricity, or specifically to direct current. The direct current produced is used to provide power to the system and to charge lead acid batteries.

The solar panel operates in both direct and diffuse light (cloudy days), but not at night.

The minimum battery size and solar panel output required depend on 1) the average current drain of the system, 2) the maximum time the battery must supply power to the system without being charged, and 3) the location of the site. When some batteries are discharged below a specified voltage, the battery becomes damaged and cannot be recharged.

On the average, the solar panel must be able to provide at least the amount of power necessary to operate the system for 24 hours. This means that the solar panels should not only be able to supply power to the system during the day, but it should also be able to provide power necessary to charge the battery for the power lost during the night. In addition, the battery must have enough capacity to power the system during times of no charging (night) and a few days of low charging (cloudy and stormy days). For additional help in computing power budget for a specific system, please contact Campbell Scientific, Inc. Applications Engineers.

5.2 Voltage Regulator

The regulator has two basic functions: 1) blocks any current flow from the battery to the solar panel, and 2) limits the source current to the battery.

The Morningstar's SunSaver SS-10-12V regulator can be purchased from CSI, and it is not shipped with SP70 solar panel. The regulator connects to the battery via the 15' long 16AWG cable shipped with the regulator. The regulator and battery should be housed in an environmental enclosure. Mounting brackets are included with the regulator for attachment to an enclosure backplate.

Campbell Scientific Companies

Campbell Scientific, Inc. (CSI)

815 West 1800 North
Logan, Utah 84321
UNITED STATES
www.campbellsci.com • info@campbellsci.com

Campbell Scientific Africa Pty. Ltd. (CSAf)

PO Box 2450
Somerset West 7129
SOUTH AFRICA
www.csafrica.co.za • cleroux@csafrica.co.za

Campbell Scientific Australia Pty. Ltd. (CSA)

PO Box 444
Thuringowa Central
QLD 4812 AUSTRALIA
www.campbellsci.com.au • info@campbellsci.com.au

Campbell Scientific do Brazil Ltda. (CSB)

Rua Luisa Crapsi Orsi, 15 Butantã
CEP: 005543-000 São Paulo SP BRAZIL
www.campbellsci.com.br • suporte@campbellsci.com.br

Campbell Scientific Canada Corp. (CSC)

11564 - 149th Street NW
Edmonton, Alberta T5M 1W7
CANADA
www.campbellsci.ca • dataloggers@campbellsci.ca

Campbell Scientific Centro Caribe S.A. (CSCC)

300 N Cementerio, Edificio Breller
Santo Domingo, Heredia 40305
COSTA RICA
www.campbellsci.cc • info@campbellsci.cc

Campbell Scientific Ltd. (CSL)

Campbell Park
80 Hathern Road
Shepshed, Loughborough LE12 9GX
UNITED KINGDOM
www.campbellsci.co.uk • sales@campbellsci.co.uk

Campbell Scientific Ltd. (France)

Miniparc du Verger - Bat. H
1, rue de Terre Neuve - Les Ulis
91967 COURTABOEUF CEDEX
FRANCE
www.campbellsci.fr • info@campbellsci.fr

Campbell Scientific Spain, S. L.

Psg. Font 14, local 8
08013 Barcelona
SPAIN
www.campbellsci.es • info@campbellsci.es

Please visit www.campbellsci.com to obtain contact information for your local US or International representative.