

SnowVUE™ 10

Digital Snow Depth Sensor



Table of contents

1. Introduction	1
2. Precautions	1
3. Initial inspection	1
4. QuickStart	1
5. Overview	5
6. Specifications	6
7. Installation	7
7.1 Wiring	7
7.2 Programming	8
7.2.1 CRBasic programming	9
7.3 Beam angle	9
7.4 Mounting height	10
7.4.1 Reference point	10
7.5 Mounting	11
8. Operation	13
8.1 Quality numbers	14
8.2 Pitch, roll, and tilt axis	14
8.3 Temperature compensation	15
8.4 SDI-12 measurements	16
9. Maintenance and troubleshooting	19
9.1 Disassembly/assembly procedures	19
9.2 Data interpretation	21
9.3 Data filtering	21
Appendix A. Importing Short Cut code into CRBasic Editor	23

1. Introduction

The SnowVUE™10 sonic ranging sensor provides a non-contact method for measuring snow depth. The sensor emits an ultrasonic pulse, measures the elapsed time between the emission and return of the pulse, then uses this measurement to determine snow depth. An air temperature measurement is required to correct for variations of the speed of sound in air.



2. Precautions

- READ AND UNDERSTAND the [Safety](#) section at the back of this manual.
- Never open the sensor while it is connected to power or any other device.
- Always disconnect the sensor using the connector or disconnect the cable wires from their termination points.
- Follow local regulations (see Compliance in [Specifications](#) (p. 6)).

3. Initial inspection

Upon receipt of the sensor, inspect the packaging for any signs of shipping damage and, if found, report the damage to the carrier in accordance with policy. The contents of the package should also be inspected and a claim filed if any shipping related damage is discovered.

4. QuickStart

A video that describes data logger programming using *Short Cut* is available at: www.campbellsci.com/videos/cr1000x-data-logger-getting-started-program-part-3 . *Short Cut* is an easy way to program your data logger to measure the sensor and assign data logger wiring terminals. *Short Cut* is available as a download on www.campbellsci.com . It is included in installations of *LoggerNet*, *RTDAQ*, and *PC400*.

1. Open *Short Cut* and click **Create New Program**.
2. Double-click the data logger model.

NOTE:

A reference temperature measurement is required for accurate readings. This example uses the 109 Temperature Probe.

3. In the **Available Sensors and Devices** box, type 109 or find the 109 in the **Sensors > Temperature** folder. Double click the **109 Temperature Probe**. Use the default of **Deg C**.

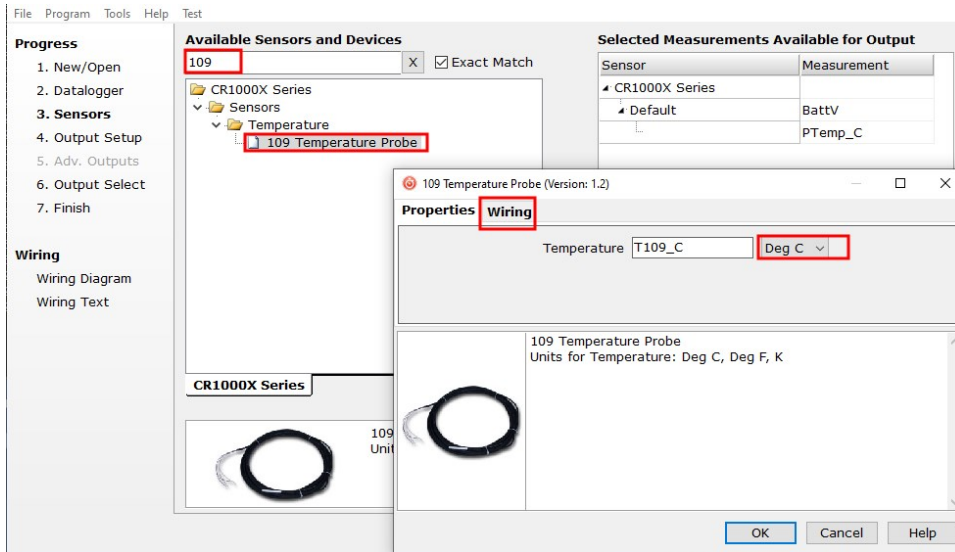

4. Click the **Wiring** tab to see how the sensor is to be wired to the data logger. Click **OK** after wiring the sensor.

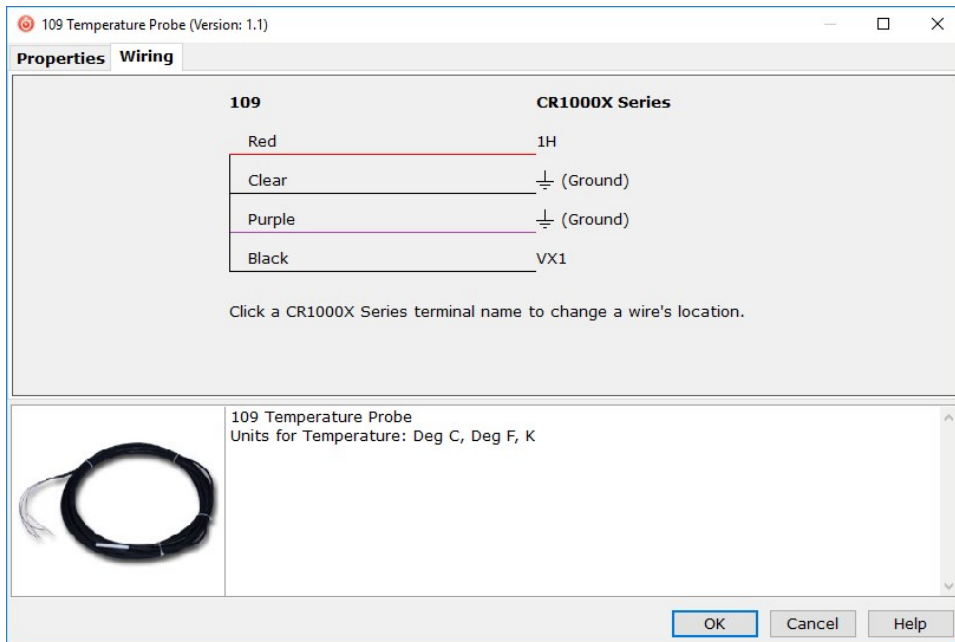

- In the **Available Sensors and Devices** box, type SnowVUE 10. You can also find the sensor in the **Sensors > Miscellaneous Sensors** folder. Double-click the **SnowVUE10 Digital Snow Depth Sensor**. Type the **Distance to base**, which is the distance from the wire mesh face to the ground; this value should be in the same units as the **Units of measure**. The default for **Units of measure** is **m**; this can be changed by clicking the **Units of measure** box and selecting another value. **SDI-12 Address** defaults to 0. Type the correct **SDI-12 Address** if it has been changed from the factory-set default value. Click the **Air temperature (Deg C) reference** box and select the reference temperature variable (T109_C).

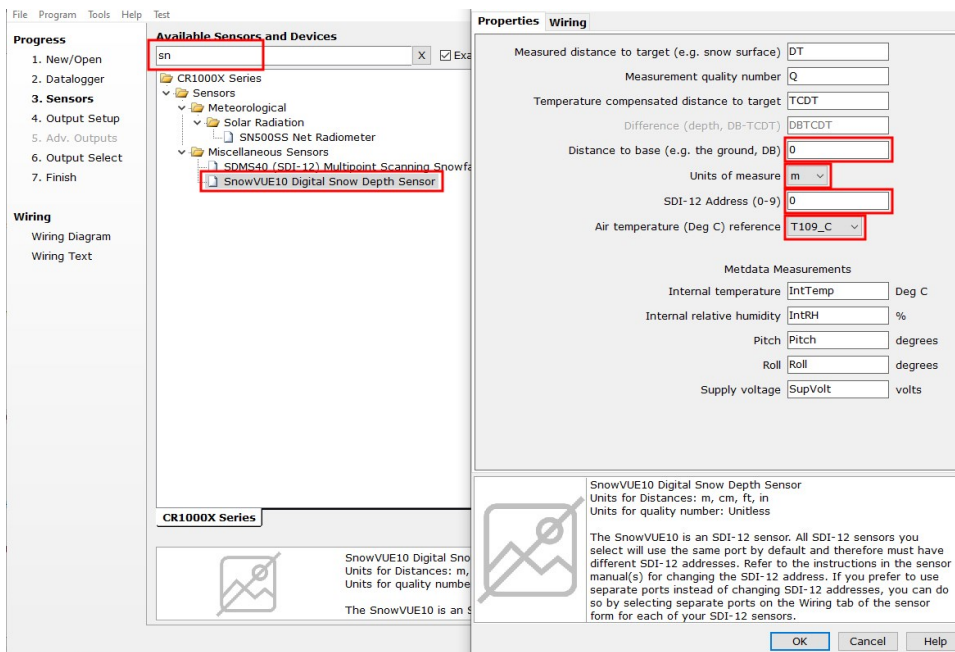

- Click the **Wiring** tab to see how the sensor is to be wired to the data logger. Click **OK** after wiring the sensor.

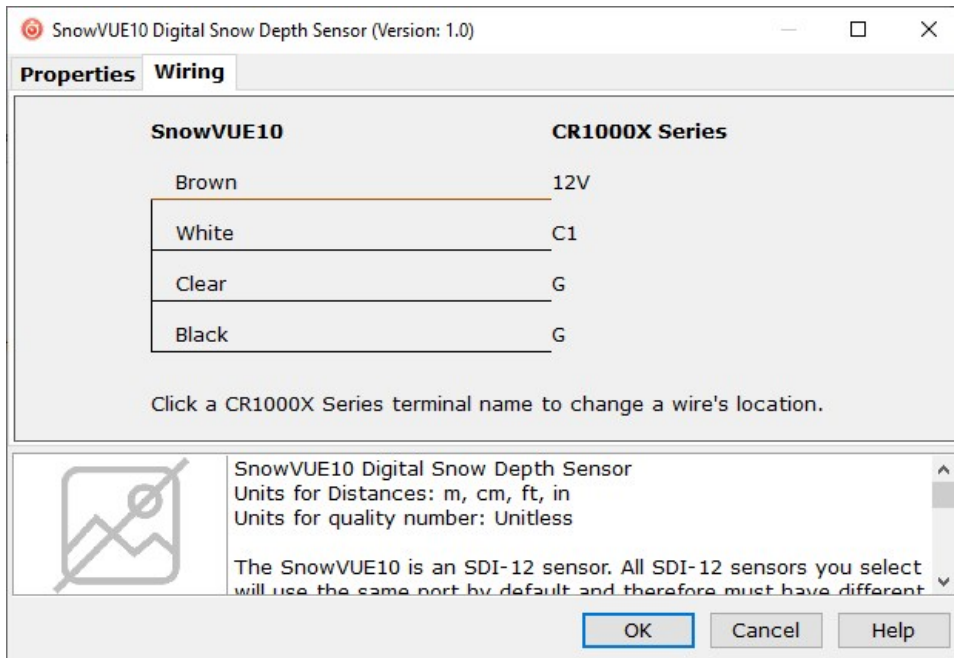

- Repeat steps five and six for other sensors. Click **Next**.
- In **Output Setup**, type the scan rate, meaningful table names, and **Data Output Storage Interval**. Click **Next**. For this sensor, Campbell Scientific recommends measurement scans of 15 seconds or more.

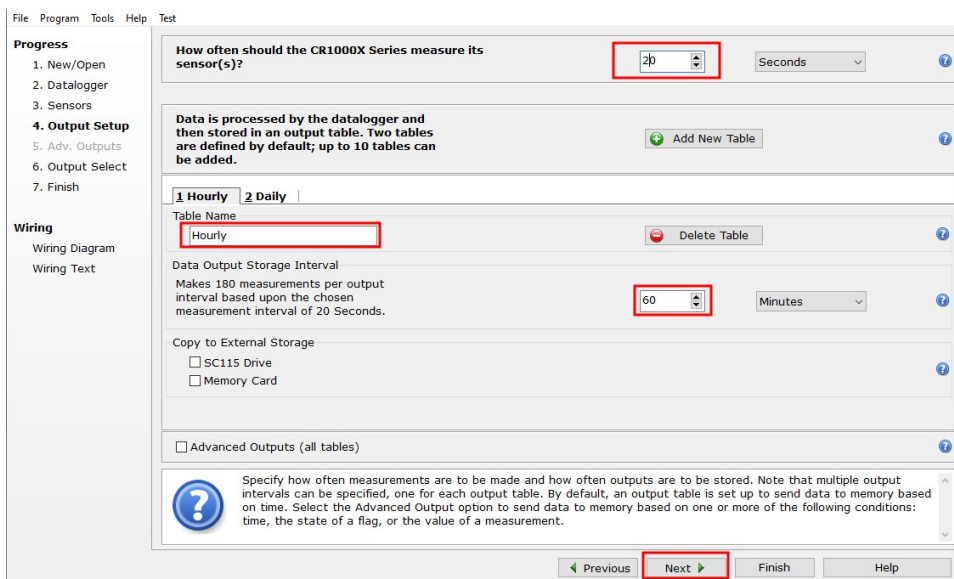

9. Select the output options.

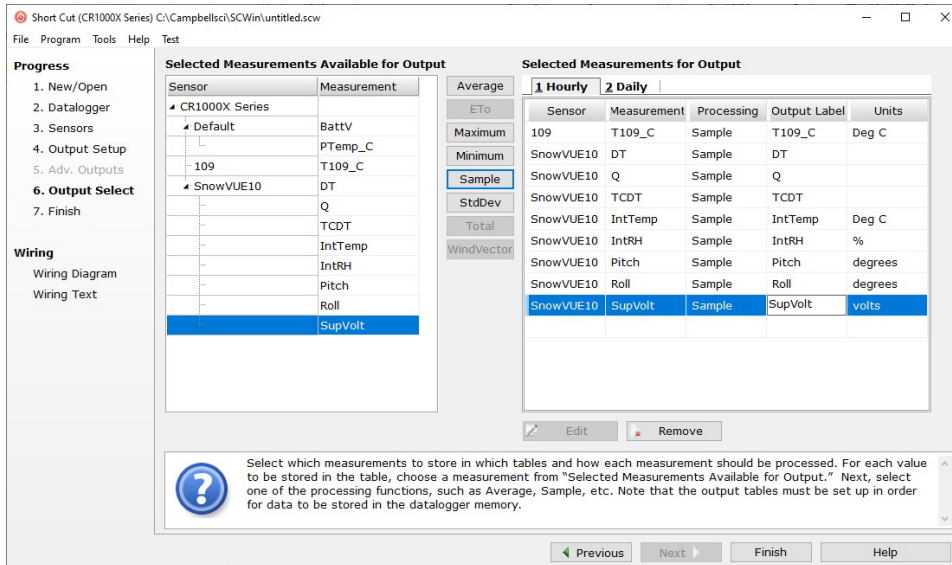

10. Click **Finish** and save the program. Send the program to the data logger if the data logger is connected to the computer.
11. If the sensor is connected to the data logger, check the output of the sensor in the data display in *LoggerNet*, *RTDAQ*, or *PC400* to make sure it is making reasonable measurements.

5. Overview

The SnowVUE 10 measures the distance from the sensor to a target. It determines the distance to a target by sending ultrasonic pulses (50 kHz) and listening for the returning echoes that are reflected from the target. The time from pulse transmission to return of the echo is the basis for obtaining the distance measurement. The SnowVUE 10 is designed for extreme cold and corrosive environments, making it well suited for a wide range of applications.

Since the speed of sound in air varies with temperature, an independent temperature measurement is required to compensate the distance reading. The SnowVUE 10 requires an external temperature sensor, such as the 109, to provide the measurement.

The SnowVUE 10 meets the stringent requirements of snow depth measurement making it well suited for a variety of applications. The SnowVUE 10 has a type III anodized aluminum chassis with a rugged transducer that withstands many environments.



FIGURE 5-1. The anodized chassis protects the SnowVUE 10.

Features:

- Wide operating temperature range
- Uses a multiple echo processing algorithm to help ensure measurement reliability
- Can output a data value indicative of measurement quality ([Quality numbers](#) (p. 14))
- Compatible with Campbell Scientific CRBasic data loggers: GRANITE series, CR6, CR1000X, CR800 series, CR300 series, CR3000, and CR1000

6. Specifications

Power requirements:	9 to 18 VDC
Quiescent current consumption:	< 300 μ A
Active current consumption:	210 mA peak, 14 mA average @ 20 °C
Measurement time:	5 s typical, 20 s maximum
Output:	SDI-12 (version 1.4)
Measurement range:	0.4 to 10 m (1.3 to 32.8 ft)
Accuracy:	0.2% of distance to target Accuracy specification excludes errors in the temperature compensation. An external temperature compensation is required.
Resolution:	0.1 mm

Required beam angle clearance:	30 °
Operating temperature range:	–45 to 50 °C
Sensor connector type:	M12, male, 5-pole, A-coded
Maximum cable length:	60 m (197 ft)
Cable type:	3 conductor, polyurethane sheathed, screened cable, nominal diameter 4.8 mm (0.19 in)
Chassis types:	Corrosion-resistant, type III anodized aluminum
Sensor length:	9.9 cm (3.9 in)
Sensor diameter:	7.6 cm (3 in)
Sensor weight (no cable):	293 g (10.3 oz) without cable
Cable weight (15 ft):	250 g (8.2 oz)
IP rating	
Electrical housing:	IP67
Transducer:	IP64
Compliance:	This device complies with Part 15 of the USA Federal Communications Commission (FCC) Rules. Operation in the USA is subject to the following two conditions: <ul style="list-style-type: none"> 1. This device may not cause harmful interference. 2. This device must accept any interference received, including interference that may cause undesired operation.
Compliance documents:	View at www.campbellsci.com/snowvue10 

7. Installation

If you are programming your data logger with *Short Cut*, skip [Wiring](#) (p. 7) and [Programming](#) (p. 8). *Short Cut* does this work for you. See [QuickStart](#) (p. 1) for a *Short Cut* tutorial.

7.1 Wiring

The following table provides wiring information for the SnowVUE 10.

CAUTION:

Power down your system before wiring the sensor. Never operate the sensor with the shield wire disconnected. The shield wire plays an important role in noise emissions and susceptibility as well as transient protection.

Table 7-1: Wire color, function, and data logger connection

Wire color	Wire function	Data logger connection terminal
Black	Power ground	G
Brown	Power	12V
White	SDI-12 signal	C ¹ , SDI-12, or U configured for SDI-12 ¹
Clear	Shield	G

¹ C and U terminals are automatically configured by the measurement instruction.

To use more than one sensor per data logger, either connect the different sensors to different terminals on the data logger or change the SDI-12 addresses such that each sensor has a unique SDI-12 address. Using unique SDI-12 addresses reduces the number of terminals used on the data logger and allows sensors to be connected in a daisy-chain that can minimize cable runs in some applications.

For the GRANITE-series, CR6, and CR1000X data loggers, triggering conflicts may occur when a companion terminal is used for a triggering instruction such as `TimerInput()`, `PulseCount()`, or `WaitDigTrig()`. For example, if the SnowVUE 10 is connected to C3 on a CR1000X, C4 cannot be used in the `TimerInput()`, `PulseCount()`, or `WaitDigTrig()` instructions.

Regardless of the data logger, if enough terminals are available, avoid using the companion terminal for another device.

7.2 Programming

Short Cut is the best source for up-to-date programming code for Campbell Scientific data loggers. If your data acquisition requirements are simple, you can probably create and maintain a data logger program exclusively with *Short Cut*. If your data acquisition needs are more complex, the files that *Short Cut* creates are a great source for programming code to start a new program or add to an existing custom program.

NOTE:

Short Cut cannot edit programs after they are imported and edited in *CRBasic Editor*.

A *Short Cut* tutorial is available in [QuickStart](#) (p. 1). If you wish to import *Short Cut* code into *CRBasic Editor* to create or add to a customized program, follow the procedure in [Importing Short Cut code into CRBasic Editor](#) (p. 23).

Programming basics for CRBasic data loggers are provided in the following section.

Downloadable example programs are available at

www.campbellsci.com/downloads/snowvue10-example-programs .

7.2.1 CRBasic programming

The `SDI12Recorder()` instruction sends a request to the sensor to make a measurement and then retrieves the measurement from the sensor. See [SDI-12 measurements](#) (p. 16) for more information.

For most data loggers, the `SDI12Recorder()` instruction has the following syntax:

```
SDI12Recorder(Destination, SDIPort, SDIAddress, "SDICommand", Multiplier, Offset, FillNaN, WaitonTimeout)
```

Valid values for the **SDIAddress** are 0 through 9, A through Z, and a through z; alphabetical characters need to be enclosed in quotes (for example, "A"). Also enclose the **SDICommand** in quotes as shown. The **Destination** parameter must be an array. The required number of values in the array depends on the command (see [Table 8-2](#) (p. 16)).

FillNaN and **WaitonTimeout** are optional parameters (refer to CRBasic Help for more information).

7.3 Beam angle

When mounting the SnowVUE 10, the beam angle needs to be considered. Mount the SnowVUE 10 perpendicular to the intended target surface. The SnowVUE 10 has a beam angle of approximately 30 degrees. This means that objects outside this 30-degree beam will not be detected nor interfere with the intended target. Any unwanted target must be outside the 30-degree beam angle.

Determine the required clearance for the beam angle using the following formula and [FIGURE 7-1](#) (p. 10).

Clearance Radius formula:

$$\text{CONE}_{\text{radius}} = 0.268(\text{CONE}_{\text{height}})$$

Where,

$\text{CONE}_{\text{height}}$ = the distance to base ([Reference point](#) (p. 10))

$\text{CONE}_{\text{radius}}$ = clearance radius in the same measurement units as the $\text{CONE}_{\text{height}}$

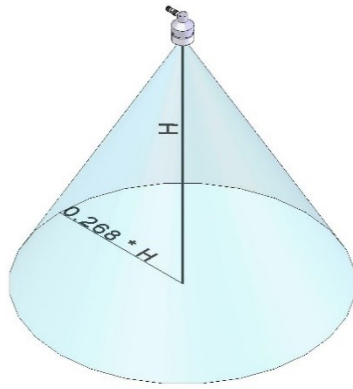

FIGURE 7-1. Beam angle clearance

7.4 Mounting height

Mount the SnowVUE 10 so that the face of the transducer is at least 70 cm (27.5 in) away from the target. However, mounting the sensor too far from the target can increase the absolute error. For example, if your sensor is measuring snow depth in an area that will likely not exceed 1.25 m (4.1 ft), then a good height to mount the sensor will be 2.0 to 2.2 m (5.74 to 7.22 ft). Mounting the sensor at a 4 m (13.1 ft) height can result in larger snow depth errors.

7.4.1 Reference point

The front grill on the ultrasonic transducer is used as the reference for the distance values. Because of the difficulty of measuring from the grill, most users measure the distance from the target to the outer edge of the plastic transducer housing (FIGURE 7-2 (p. 11)) and then add 8 mm (0.3 in) to the measured distance.



FIGURE 7-2. Distance from edge of transducer housing to grill

7.5 Mounting

To achieve an unobstructed view for the beam, the SnowVUE 10 is typically mounted to a tripod mast, tower leg, or user-supplied pole, using the CM206 6-ft crossarm or a pipe with a 1-inch to 1.75-inch outer diameter. The SnowVUE 10 Mounting Kit attaches directly to the crossarm or pipe. FIGURE 7-3 (p. 12) shows the SnowVUE 10 mounted to a crossarm using the mounting kit. A U-bolt mounts the bracket to the crossarm and two screws fasten the SnowVUE 10 to the bracket.

The SnowVUE 10 Mounting Stem (FIGURE 7-4 (p. 12)) attaches to the crossarm using the 1-inch-by-1-inch Nu-Rail fitting (FIGURE 7-5 (p. 13)), CM220 right-angle mount, CM230 adjustable-angle mount, or CM230XL extended adjustable-angle mount. Use the CM230 or CM230XL if the ground surface is at an angle.



FIGURE 7-3. Crossarm installation using the SnowVUE 10 mounting kit



FIGURE 7-4. SnowVUE 10 mounting stem



FIGURE 7-5. SnowVUE 10 mounted to a crossarm using the mounting stem and a 1-inch-by-1-inch Nu-Rail fitting

8. Operation

The SnowVUE 10 bases every measurement on several readings and applies an algorithm to improve measurement reliability. The distance to target readings that are obtained from the sensor are referenced from the metal mesh on the face of the transducer. The SnowVUE 10 transmits an ultrasonic beam that detects objects within a 30-degree field-of-view (see [Beam angle](#) (p. 9)).

The SnowVUE 10 completes a measurement and outputs the data typically in 10 to 15 seconds, depending on the target distance, target type, and noise in the environment.

The SnowVUE 10 may reject readings from a moving target. If the SnowVUE 10 rejects a reading or does not detect a target, zero will be output for the distance to target and zero will be output for the quality number.

8.1 Quality numbers

The following table describes the measurement quality numbers provided in the output data. These numbers indicate the measurement certainty. The quality number is calculated as the standard deviation of multiple readings used to return one distance value. Zero indicates the reading was not obtained. Numbers greater than 300 indicate a degree of uncertainty in the measurement. Causes of high numbers include:

- sensor is not perpendicular to the target surface
- target is small and reflects little sound
- target surface is rough or uneven
- target surface is a poor reflector of sound (extremely low-density snow)

Quality number range	Quality range description
0	Not able to read distance
1 to 100	Good measurement quality numbers
100 to 300	Reduced echo signal strength
300 to 600	High measurement uncertainty

Although not necessary, quality numbers provide useful information such as surface density in snow monitoring applications. Please note that quality number values may increase during snowfall events consisting of low-density snow.

8.2 Pitch, roll, and tilt axis

The SnowVUE 10 reports pitch and roll to ensure that the sensor is mounted perpendicular to the intended target surface. The front of the sensor is the face with the vent on it (opposite the connector). When the vent tilts forward or backwards (around the X-axis), that is pitch (FIGURE 8-1 (p. 15), FIGURE 8-2 (p. 15)). If you rotate the sensor around the axis of the vent (Y-axis) or connector, that is roll. The etchings are on the "sides" of the sensor; product model on one side, company logo on the other.

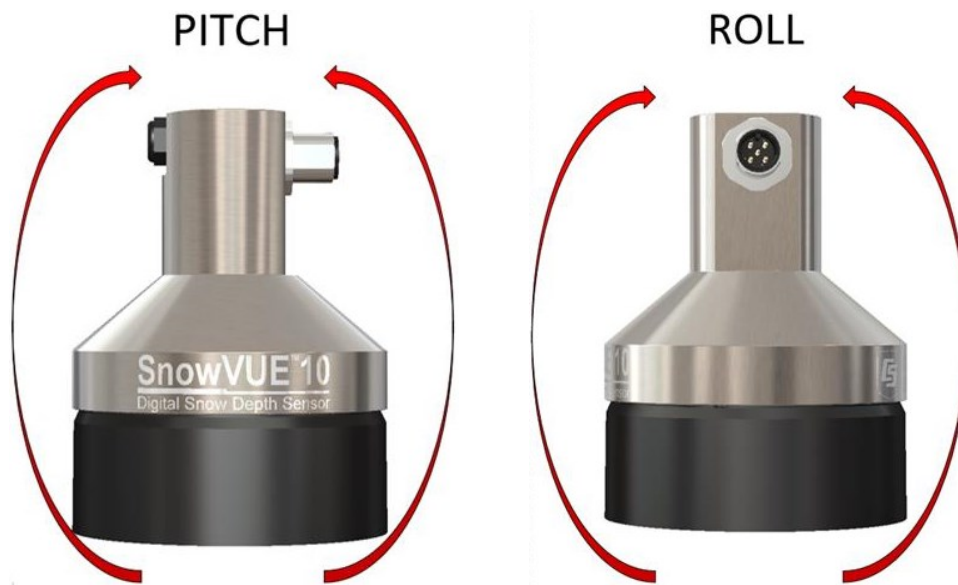

FIGURE 8-1. Pitch and roll diagram

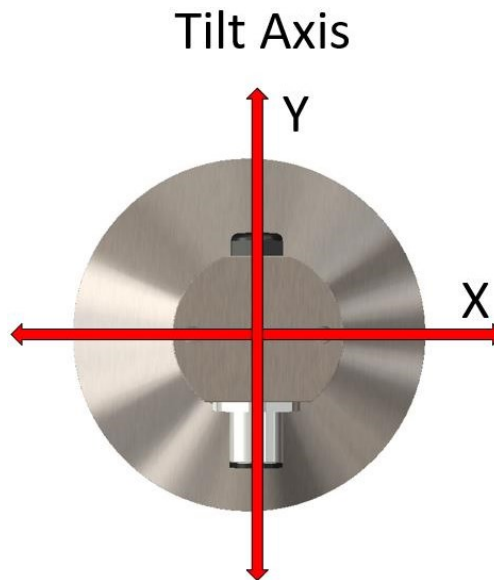

FIGURE 8-2. Tilt axis

8.3 Temperature compensation

Temperature corrections for the speed of sound must be applied to the readings by using measurements from a reliable and accurate temperature sensor, such as the 109. The temperature sensor needs to be housed in a radiation shield. Temperature compensation is applied to the SnowVUE 10 output using the following formula:

$$DISTANCE = READING_{SnowVUE10} \sqrt{\frac{T^{\circ} KELVIN}{273.15}}$$

CAUTION:

The SnowVUE 10 calculates distance readings using the speed of sound at 0 °C (331.4 m/s). If the temperature compensation formula is not applied, the distance values will not be accurate for temperatures other than 0 °C.

8.4 SDI-12 measurements

The SDI-12 protocol supports the SDI-12 commands listed in [Table 8-2](#) (p. 16).

NOTE:

The SnowVUE 10 needs to be powered for 1.5 s before it can receive an SDI-12 command.

The different commands are entered as options in the SDI-12 recorder instruction. If the SnowVUE 10 is unable to detect a proper echo for a measurement, the sensor will return a zero value for the distance to target value.

SDI-12 ¹ command	Values returned or function	Units	Max. sensor response time
aM!, aC!	Distance	m	20 sec
aM1!, aC1!	1. Distance 2. Quality number	1. m 2. N/A (not applicable)	20 sec
aM2!, aC2!	1. Distance 2. Reference temperature	1. m 2. °C	20 sec
aM3!, aC3!	1. Distance 2. Quality number 3. Reference temperature	1. m 2. N/A 3. °C	20 sec
aM4!, aC4!	1. Snow depth 2. Quality number 3. Reference temperature	1. m 2. N/A 3. °C	20 sec

Table 8-2: SDI-12 commands

SDI-12 ¹ command	Values returned or function	Units	Max. sensor response time
aM9!, aC9!	<ol style="list-style-type: none"> 1. External temperature 2. Internal temperature 3. Internal RH 4. Pitch 5. Roll 6. Supply voltage 7. Resonant frequency (should be 50 kHz) 8. Alert flag 0 = good 1 = transducer outside of normal operating range 	<ol style="list-style-type: none"> 1. °C 2. °C 3. % 4. ° 5. ° 6. V 7. kHz 8. N/A 	3 sec
aI!	a14CampbellSnow10vvvSN=nnnn SDI-12 address: a SDI-12 version: 14 vendor: Campbell model: Snow10 vvv: numeric firmware version SN = Serial number (5 digits)		
?!	SDI-12 address		
aAb!	Change address command; b is the new address		
aXWM+D.DD! Extended command	Set the distance to ground parameter in the SnowVUE 10. The distance must be no more than four decimal places.	m	
aXWT+CC.C! Extended command	Set reference temperature. The temperature must be in degrees Celsius with a maximum of one decimal place.	°C	

SDI-12 ¹ command	Values returned or function	Units	Max. sensor response time
aXRM!	Returns the distance to ground setting. It returns four decimal places.	m	
aXRT!	Returns the reference temperature. This value remains the same unless power is cycled or a new temperature value is sent.	° C	
aR3!	Returns the CPU temperature	° C	

¹Where a = address of SDI-12 device.

When using the **M!** command, the data logger waits for the time specified by the sensor, sends the **D!** command, pauses its operation, and waits until either it receives the data from the sensor or the sensor timeout expires. If the data logger receives no response, it will send the command a total of three times, with three retries for each attempt, or until a response is received. Because of the delays this command requires, it is only recommended in measurement scans of 20 seconds or more.

The **C!** command follows the same pattern as the **M!** command with the exception that it does not require the data logger to pause its operation until the values are ready. Rather, the data logger picks up the data with the **D!** command on the next pass through the program. Another measurement request is then sent so that data is ready on the next scan.

9. Maintenance and troubleshooting

Replace the transducer assembly every three years if it is not in a humid environment. Replace the transducer housing assembly every year in humid environments.

9.1 Disassembly/assembly procedures

The following figures show the procedure for disassembling the SnowVUE 10. Disassembly is required to change the transducer.

CAUTION:

Before proceeding with any maintenance, always retrieve the data first. Campbell Scientific also recommends saving the data logger program.

CAUTION:

Always disconnect the SnowVUE 10 from the data logger or the connector before disassembling.

1. Disconnect cable from sensor.
2. Remove six screws from the transducer housing.



FIGURE 9-1. Transducer screws

3. Remove transducer housing and disconnect wires.



FIGURE 9-2. Disassembled SnowVUE 10

4. Carefully reassemble in reverse order.

9.2 Data interpretation

Although not common, the SnowVUE 10 can output invalid-reading indicators if unable to obtain a measurement. For invalid distance-to-target values, 0 is returned to indicate an error. For snow depth outputs and temperature reading outputs, the error indicator value is -999. Invalid readings can be easily filtered out when analyzing the data. Invalid readings should be detected and discarded in control-type applications.

9.3 Data filtering

The following scenarios can produce values with higher than expected errors:

1. Low-density snow results in weak echos returned to the sensor.
2. Weak signal, as indicated by an increased number of echo-quality numbers returned to the sensor.

Under these circumstances, a SnowVUE 10 can under, or over, estimate snow depth. If the signal is too weak, the sensor will output a value of 0 for the distance to target. When the echoes are weak, the sensor automatically increases sensitivity, which makes the sensor prone to erroneous readings from flying debris, drifting snow, or obstruction near the beam angle.

The reason not to average values is that high-error values can skew the average. The best technique to eliminate errors and filter out high-error readings is to take the median value. This technique also helps to automatically filter out zero readings.

Table 9-1 (p. 21) shows a station that reads the SnowVUE 10 every 5 seconds for 1 minute and takes the median value from the readings.

Consecutive snow-depth values	Values sorted from low to high
0.33	-1.1
0.34	0.10
0.35	0.28
-1.1 (erroneous reading)	0.32
2.0 (erroneous reading)	0.33
0.37	0.33
0.28	0.34
0.36	0.35

Table 9-1: Data filtering example	
Consecutive snow-depth values	Values sorted from low to high
0.10 (high error value)	0.36
0.33	0.37
0.32	2.0

The best course of action would be to ignore the five lowest values and take the sixth value (0.33).

Appendix A. Importing *Short Cut* code into *CRBasic Editor*

Short Cut creates a .DEF file that contains wiring information and a program file that can be imported into the *CRBasic Editor*. By default, these files reside in the C:\campbellsci\SCWin folder.

Import *Short Cut* program file and wiring information into *CRBasic Editor*:

1. Create the *Short Cut* program. After saving the *Short Cut* program, click the **Advanced** tab then the **CRBasic Editor** button. A program file with a generic name will open in CRBasic. Provide a meaningful name and save the CRBasic program. This program can now be edited for additional refinement.

NOTE:

Once the file is edited with *CRBasic Editor*, *Short Cut* can no longer be used to edit the program it created.

2. To add the *Short Cut* wiring information into the new CRBasic program, open the .DEF file located in the C:\campbellsci\SCWin folder, and copy the wiring information, which is at the beginning of the .DEF file.
3. Go into the CRBasic program and paste the wiring information into it.
4. In the CRBasic program, highlight the wiring information, right-click, and select **Comment Block**. This adds an apostrophe (') to the beginning of each of the highlighted lines, which instructs the data logger compiler to ignore those lines when compiling. The **Comment Block** feature is demonstrated at about 5:10 in the [CRBasic | Features](#) video .

Limited warranty

Products manufactured by Campbell Scientific are warranted by Campbell Scientific to be free from defects in materials and workmanship under normal use and service for twelve months from the date of shipment unless otherwise specified on the corresponding product webpage. See Product Details on the Ordering Information pages at www.campbellsci.com[↗]. Other manufacturer's products, that are resold by Campbell Scientific, are warranted only to the limits extended by the original manufacturer.

Refer to www.campbellsci.com/terms#warranty[↗] for more information.

CAMPBELL SCIENTIFIC EXPRESSLY DISCLAIMS AND EXCLUDES ANY IMPLIED WARRANTIES OF MERCHANTABILITY OR FITNESS FOR A PARTICULAR PURPOSE. Campbell Scientific hereby disclaims, to the fullest extent allowed by applicable law, any and all warranties and conditions with respect to the Products, whether express, implied or statutory, other than those expressly provided herein.

Assistance

Products may not be returned without prior authorization.

Products shipped to Campbell Scientific require a Returned Materials Authorization (RMA) or Repair Reference number and must be clean and uncontaminated by harmful substances, such as hazardous materials, chemicals, insects, and pests. Please complete the required forms prior to shipping equipment.

Campbell Scientific regional offices handle repairs for customers within their territories. Please see the back page for the Global Sales and Support Network or visit www.campbellsci.com/contact  to determine which Campbell Scientific office serves your country.

To obtain a Returned Materials Authorization or Repair Reference number, contact your CAMPBELL SCIENTIFIC regional office. Please write the issued number clearly on the outside of the shipping container and ship as directed.

For all returns, the customer must provide a "Statement of Product Cleanliness and Decontamination" or "Declaration of Hazardous Material and Decontamination" form and comply with the requirements specified in it. The form is available from your CAMPBELL SCIENTIFIC regional office. Campbell Scientific is unable to process any returns until we receive this statement. If the statement is not received within three days of product receipt or is incomplete, the product will be returned to the customer at the customer's expense. Campbell Scientific reserves the right to refuse service on products that were exposed to contaminants that may cause health or safety concerns for our employees.

Safety

DANGER — MANY HAZARDS ARE ASSOCIATED WITH INSTALLING, USING, MAINTAINING, AND WORKING ON OR AROUND TRIPODS, TOWERS, AND ANY ATTACHMENTS TO TRIPODS AND TOWERS SUCH AS SENSORS, CROSSARMS, ENCLOSURES, ANTENNAS, ETC. FAILURE TO PROPERLY AND COMPLETELY ASSEMBLE, INSTALL, OPERATE, USE, AND MAINTAIN TRIPODS, TOWERS, AND ATTACHMENTS, AND FAILURE TO HEED WARNINGS, INCREASES THE RISK OF DEATH, ACCIDENT, SERIOUS INJURY, PROPERTY DAMAGE, AND PRODUCT FAILURE. TAKE ALL REASONABLE PRECAUTIONS TO AVOID THESE HAZARDS. CHECK WITH YOUR ORGANIZATION'S SAFETY COORDINATOR (OR POLICY) FOR PROCEDURES AND REQUIRED PROTECTIVE EQUIPMENT PRIOR TO PERFORMING ANY WORK.

Use tripods, towers, and attachments to tripods and towers only for purposes for which they are designed. Do not exceed design limits. Be familiar and comply with all instructions provided in product manuals. Manuals are available at www.campbellsci.com. You are responsible for conformance with governing codes and regulations, including safety regulations, and the integrity and location of structures or land to which towers, tripods, and any attachments are attached. Installation sites should be evaluated and approved by a qualified engineer. If questions or concerns arise regarding installation, use, or maintenance of tripods, towers, attachments, or electrical connections, consult with a licensed and qualified engineer or electrician.

General

- Protect from over-voltage.
- Protect electrical equipment from water.
- Protect from electrostatic discharge (ESD).
- Protect from lightning.
- Prior to performing site or installation work, obtain required approvals and permits. Comply with all governing structure-height regulations.
- Use only qualified personnel for installation, use, and maintenance of tripods and towers, and any attachments to tripods and towers. The use of licensed and qualified contractors is highly recommended.
- Read all applicable instructions carefully and understand procedures thoroughly before beginning work.
- Wear a **hardhat** and **eye protection**, and take **other appropriate safety precautions** while working on or around tripods and towers.
- **Do not climb** tripods or towers at any time, and prohibit climbing by other persons. Take reasonable precautions to secure tripod and tower sites from trespassers.
- Use only manufacturer recommended parts, materials, and tools.

Utility and Electrical

- **You can be killed** or sustain serious bodily injury if the tripod, tower, or attachments you are installing, constructing, using, or maintaining, or a tool, stake, or anchor, come in **contact with overhead or underground utility lines**.
- Maintain a distance of at least one-and-one-half times structure height, 6 meters (20 feet), or the distance required by applicable law, **whichever is greater**, between overhead utility lines and the structure (tripod, tower, attachments, or tools).
- Prior to performing site or installation work, inform all utility companies and have all underground utilities marked.
- Comply with all electrical codes. Electrical equipment and related grounding devices should be installed by a licensed and qualified electrician.
- Only use power sources approved for use in the country of installation to power Campbell Scientific devices.

Elevated Work and Weather

- Exercise extreme caution when performing elevated work.
- Use appropriate equipment and safety practices.
- During installation and maintenance, keep tower and tripod sites clear of un-trained or non-essential personnel. Take precautions to prevent elevated tools and objects from dropping.
- Do not perform any work in inclement weather, including wind, rain, snow, lightning, etc.

Maintenance

- Periodically (at least yearly) check for wear and damage, including corrosion, stress cracks, frayed cables, loose cable clamps, cable tightness, etc. and take necessary corrective actions.
- Periodically (at least yearly) check electrical ground connections.

Internal Battery

- Be aware of fire, explosion, and severe-burn hazards.
- Misuse or improper installation of the internal lithium battery can cause severe injury.
- Do not recharge, disassemble, heat above 100 °C (212 °F), solder directly to the cell, incinerate, or expose contents to water. Dispose of spent batteries properly.

WHILE EVERY ATTEMPT IS MADE TO EMBODY THE HIGHEST DEGREE OF SAFETY IN ALL CAMPBELL SCIENTIFIC PRODUCTS, THE CUSTOMER ASSUMES ALL RISK FROM ANY INJURY RESULTING FROM IMPROPER INSTALLATION, USE, OR MAINTENANCE OF TRIPODS, TOWERS, OR ATTACHMENTS TO TRIPODS AND TOWERS SUCH AS SENSORS, CROSSARMS, ENCLOSURES, ANTENNAS, ETC.



Global Sales & Support Network

A worldwide network to help meet your needs



Campbell Scientific Regional Offices

Australia

Location: Garbutt, QLD Australia
Phone: 61.7.4401.7700
Email: info@campbellsci.com.au
Website: www.campbellsci.com.au

Brazil

Location: São Paulo, SP Brazil
Phone: 11.3732.3399
Email: vendas@campbellsci.com.br
Website: www.campbellsci.com.br

Canada

Location: Edmonton, AB Canada
Phone: 780.454.2505
Email: dataloggers@campbellsci.ca
Website: www.campbellsci.ca

China

Location: Beijing, P. R. China
Phone: 86.10.6561.0080
Email: info@campbellsci.com.cn
Website: www.campbellsci.com.cn

Costa Rica

Location: San Pedro, Costa Rica
Phone: 506.2280.1564
Email: info@campbellsci.com
Website: www.campbellsci.com

France

Location: Vincennes, France
Phone: 0033.0.1.56.45.15.20
Email: info@campbellsci.fr
Website: www.campbellsci.fr

Germany

Location: Bremen, Germany
Phone: 49.0.421.460974.0
Email: info@campbellsci.de
Website: www.campbellsci.de

India

Location: New Delhi, DL India
Phone: 91.11.46500481.482
Email: info@campbellsci.in
Website: www.campbellsci.in

South Africa

Location: Stellenbosch, South Africa
Phone: 27.21.8809960
Email: sales@campbellsci.co.za
Website: www.campbellsci.co.za

Spain

Location: Barcelona, Spain
Phone: 34.93.2323938
Email: info@campbellsci.es
Website: www.campbellsci.es

Thailand

Location: Bangkok, Thailand
Phone: 66.2.719.3399
Email: info@campbellsci.asia
Website: www.campbellsci.asia

UK

Location: Shepshed, Loughborough, UK
Phone: 44.0.1509.601141
Email: sales@campbellsci.co.uk
Website: www.campbellsci.co.uk

USA

Location: Logan, UT USA
Phone: 435.227.9120
Email: info@campbellsci.com
Website: www.campbellsci.com