



# SDM-IO16A

## 16-Channel Input/Output Expansion Module



# Table of contents

---

<b>1. Introduction</b> .....	<b>1</b>
<b>2. Specifications</b> .....	<b>2</b>
2.1 General .....	2
2.2 Terminal specifications (output mode) .....	3
2.3 Terminal specifications (input mode) .....	3
2.4 Pulse counting specifications .....	4
<b>3. Installation</b> .....	<b>6</b>
3.1 Power considerations .....	6
3.2 Terminal connections .....	7
3.3 Address selection switches .....	8
<b>4. Programming the data logger</b> .....	<b>10</b>
4.1 General principles .....	10
4.2 SDMIO16() instruction .....	11
4.3 SDMCD16AC() instruction .....	13
4.4 SDMSpeed() instruction .....	14
4.5 Command codes for the SDMIO16() instruction .....	14
<b>Appendix A. General principles of pulse and frequency measurements</b> .....	<b>20</b>
A.1 Introduction .....	20
A.2 Frequency and duty cycle measurement range .....	20
A.3 Resolution of frequency measurements .....	21
A.4 Resolution of duty cycle measurements .....	21
A.5 Debounce filtering .....	22
A.6 Using the I/O line to trigger code to run on a data logger .....	23

# 1. Introduction

---

The SDM-IO16A expands the digital input and output capability of Campbell Scientific data loggers. It offers similar functionality to the control terminals of Campbell Scientific data loggers.

The SDM-IO16A (see [FIGURE 1-1](#) (p. 2)) is a synchronously addressed peripheral. It has 16 input/output (I/O) terminals configurable for input or output which expand the number of control terminals of the data logger. It is fully compatible with Campbell Scientific GRANITE-series, CR6, CR3000, CR1000X, CR800-series, and CR1000 data loggers.

## NOTE:

This manual provides information only for current CRBasic data loggers. For retired CRBasic and Edlog data logger support, see a prior SDM-IO16 manual at [www.campbellsci.com/manuals](http://www.campbellsci.com/manuals).

When a terminal is configured as an input, it measures the logical state of the terminal, counts pulses, measures the frequency of and determines the duty cycle of signals applied to the terminal. In pulse counting mode there is also an option to enable switch debounce filtering so the unit will accurately count switch closure events. The SDM-IO16A measures the frequency of signals by measuring the time between pulses, thereby giving relatively high-resolution measurements even for low frequency signals.

The module may also be programmed to generate a signal to the data logger when one or more input signals change state, which can be used to trigger special code in the data logger. This is known as an interrupt function, as it is similar to a technique supported in microprocessors.

When configured as an output, each terminal is set to 0 or 5 V by the data logger. In addition to being able to drive normal logic level inputs, when an output is set HIGH a 'boost' circuit allows it to source a current of up to 133 mA (short-circuited to ground) at a reduced output voltage, allowing direct control of low voltage valves, relays, or other components. Refer to graph **(d) Output voltage versus current output** in [FIGURE 2-1](#) (p. 5) to see the available current at different voltages.

The SDM-IO16A is a synchronously addressed data logger peripheral. Data logger control terminals 1, 2 and 3 are used to address the SDM-IO16A and exchange digital data with it. This module uses advanced error checking techniques to ensure correct transmission of data to and from the module. Up to fifteen SDM-IO16As may be addressed, making it possible to control a maximum of 240 terminals from the first three data logger control terminals.



FIGURE 1-1. SDM-IO16A

## 2. Specifications

---

### 2.1 General

**Compatible data loggers:** GRANITE series, CR6, CR3000, CR1000X, CR800 series, and CR1000

**Operating voltage:** 12 VDC nominal (9 to 18 V)

**Current drain at 12 VDC:** 600  $\mu$ A typical standby (all terminals HIGH, no load, not pulse counting)

Maximum (no output load): 3 mA active with all 16 terminals counting pulses at 2 KHz. Above the standby level, power consumption is roughly proportional to input signal frequency and number of terminals used. Maximum 4.5 mA in high-speed mode with 1-16 terminals counting pulses from 0 Hz to 8 KHz.

Current drawn from any output must be added to the standby level to give the total current drain.

**SDM port:** 0/5 V logic level port compliant with the requirements of the Campbell Scientific SDM protocol — this is designed for connection to the data logger SDM port.

<b>Operating temperature:</b>	–40 to 70 °C standard
<b>Size:</b>	188 x 64 x 22 mm (7.4 x 2.5 x 0.9 in)
<b>Mounting:</b>	Mounting brackets have two holes at 177.8 mm (7 in) nominal spacing. Mounting screws and plastic inserts suitable for use with Campbell Scientific enclosures are also supplied.
<b>Weight:</b>	175 g (6.2 oz)
<b>EMC status:</b>	Complies with EN61326:2013
<b>Total SDM cable length:</b>	6 m (20 ft) maximum recommended

## 2.2 Terminal specifications (output mode)

<b>Output voltage (no load):</b>	Output ON/HIGH, nominal 5 V (minimum 4.5 V) Output OFF/LOW, nominal 0 V (maximum 0.1 V)
<b>Output sink current:</b>	Output will sink 8.6 mA from a 5 V source <sup>1</sup>
<b>Output source current:</b>	Output will source 42 mA @ 3 V, 133 mA short-circuited to ground <sup>1</sup>
<b>Max. output current: (total for all outputs)</b>	Limited by the 12 V supply.

## 2.3 Terminal specifications (input mode)

<b>Input voltage:</b>	Input high, 4.0 V minimum threshold Input low, 1.0 V maximum threshold All inputs feature Schmitt triggered detectors.
<b>Input protection:</b>	The input is clamped at –0.6 V and +5.6 V relative to ground via a 33 Ω resistor <sup>1</sup> . This will withstand a continuous current flow of 200 mA (including that which might be caused by accidentally connecting directly to a 12 V supply). To limit power dissipation and damage at higher voltages than 12 V, an external series current limiting resistor is recommended.
<b>Input impedance:</b>	The input is biased to +5 V relative to ground by a 100 kΩ resistor.

## 2.4 Pulse counting specifications

<b>Maximum frequency:</b>	Low-speed mode 2.048 KHz on all channels simultaneously with switch debounce-mode set off, with a 50/50 duty cycle. 150 Hz on all channels with default switch debounce timing enabled and a 50/50 duty cycle <sup>2</sup> . High-speed mode 8.192 KHz on all channels simultaneously with switch debounce-mode set off with a 50/50 duty cycle.
<b>Minimum frequency:</b>	A frequency of 0 Hz is measured if there are less than two high-to-low signal transitions in the measurement interval.
<b>Minimum pulse width:</b>	A pulse must stay high or low for a minimum of 244 $\mu$ s (low-speed mode) and 61.04 $\mu$ s (high-speed mode) for a change of state or pulse to be counted.
<b>Switch debounce timing:</b>	With the default settings, a switch between the input and G must remain closed for 3.17 ms and then remain open for 3.17 ms, to be counted as a closure. The debounce is changeable from the user program. In high-speed mode the debounce timing is one quarter of this at 0.7925 ms.
<b>Accuracy:</b>	Internal clock accuracy $\pm 0.01\%$ (worst case) over the standard temperature range of $-40$ to $70$ $^{\circ}\text{C}$ . <sup>2</sup>
<b>Duty cycle resolution:</b>	Depends on frequency and measurement interval. <sup>2</sup> The average duty cycle is measured for signals up to 4 kHz (low-speed mode) and 16 KHz (high-speed mode).
<b>Max measurement interval:</b>	For frequency or duty cycle measurements the data logger must request a measurement at an interval no longer than 4096 seconds (low-speed mode) and 1024 seconds (high-speed mode). Each channel is measurable at different intervals, both for frequency and duty cycle.

<sup>1</sup>If more detailed input/output characteristics are required, experienced users should consult the equivalent circuit diagrams and graphs shown in [FIGURE 2-1](#) (p. 5).

<sup>2</sup>See [General principles of pulse and frequency measurements](#) (p. 20) for a more detailed discussion.

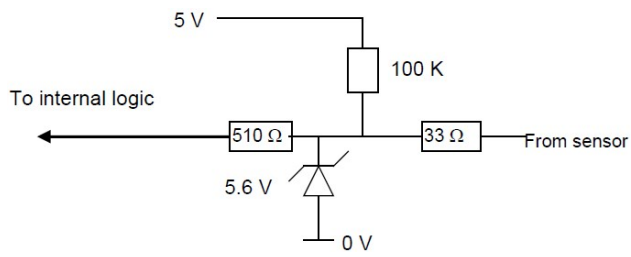

(a) Input biasing and protection

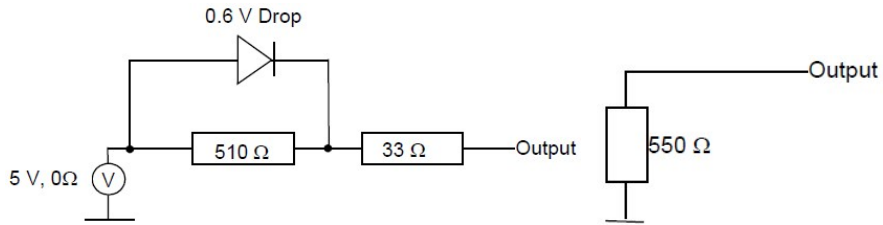

(b) Output set ON

(c) Output set OFF

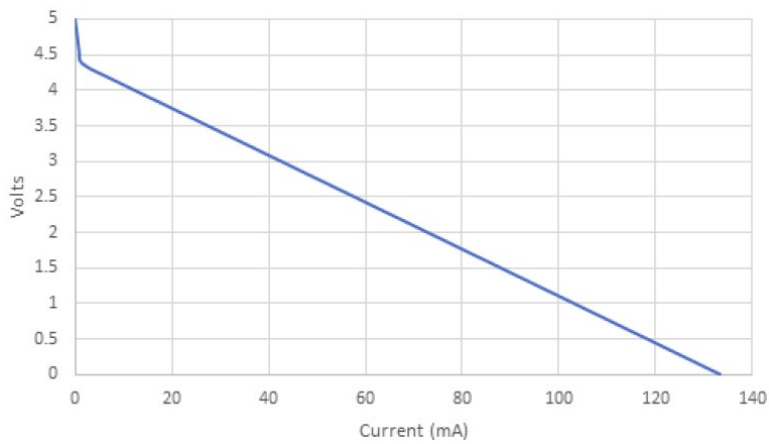

(d) Output voltage versus current output

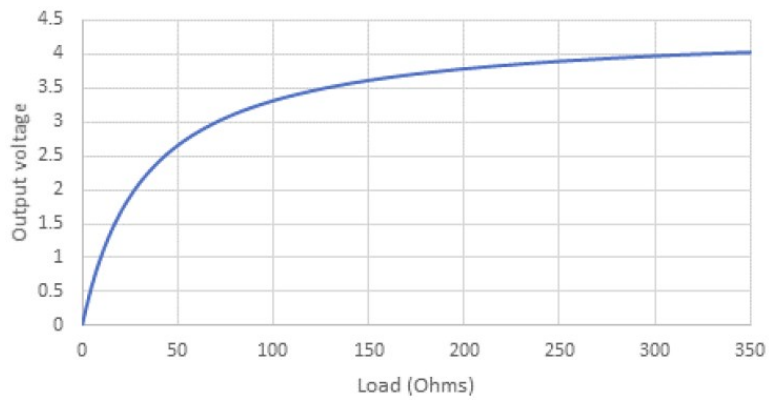

(e) Output voltage versus resistive load

FIGURE 2-1. Simplified equivalent terminal circuits and graphs of output voltage

# 3. Installation

For correct operation, the SDM-IO16A must be installed where there is no risk of water ingress or condensation.

**WARNING:**

The order in which connections are made is critical. Always connect 12 V first, followed by ground, then the SDM control terminals.

The CABLE5CBL-L or a similar cable connects the data logger to the SDM-IO16A. For data logger connections, see [Table 3-1](#) (p. 6). Refer to [FIGURE 3-2](#) (p. 8) for details of how to use the spring-loaded terminals.

Connection order	SDM-IO16A	Data logger
First	12 V	12 V on data logger or external supply
Second	⏚	G
Third	C1 C2 C3	C1 C2 C3

When using multiple SDM-IO16As, each SDM-IO16A is wired in parallel by connecting the data logger connections of one SDM-IO16A to the next.

The transient protection of the SDM-IO16A relies on a low resistance path to earth. Ensure that the ground return wire has as low a resistance as possible.

**NOTE:**

The total cable length connecting SDM-IO16As to SDM-IO16As and the data logger must not exceed 6 m (20 ft). Total cable lengths in excess of 6 m (20 ft) will adversely affect communications between the module and data logger.

## 3.1 Power considerations

For most applications, especially for pulse counting or status inputs, the data logger supply is used to power the SDM-IO16A, as shown in [FIGURE 3-1](#) (p. 7) (a).



When being used for control and outputting current the SDM-IO16A power requirements will be large compared to most Campbell Scientific products when driving significant loads. For this type of application an external power supply, as shown in [FIGURE 3-1](#) (p. 7) (b), is recommended to power the SDM-IO16A.

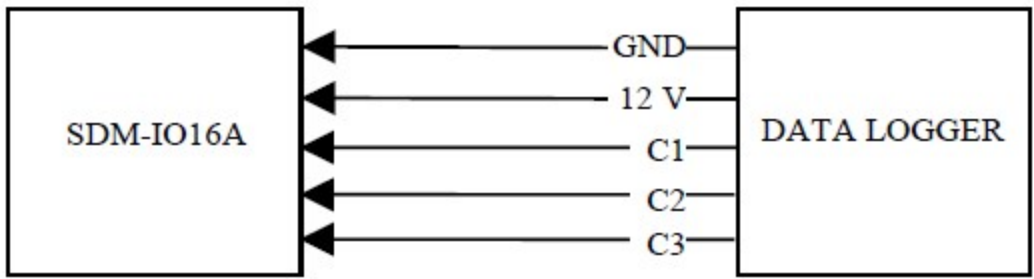

(a) Connection with data logger supply

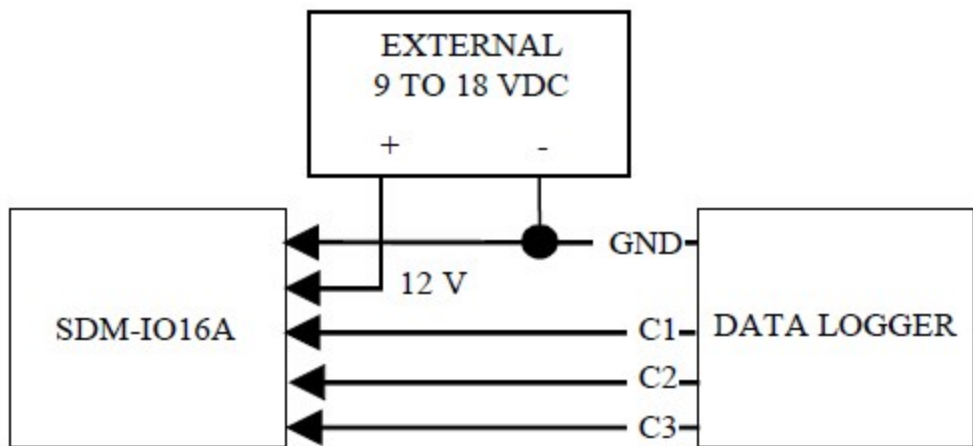

(b) Connection with external supply

*FIGURE 3-1. Connection block diagrams*

## 3.2 Terminal connections

The SDM-IO16A uses spring-loaded terminals for each connection, which provide quick, vibration resistant connections. The I/O terminals are labeled 1 to 16. A common ground terminal is provided between each pair of I/O terminals.

Strip any insulation from the wire to give 7 to 9 mm bare wire. Use a screwdriver to push against the orange lever to open the terminal contact in either the top or front slot, as appropriate. Push the wire into the opening, and, while holding it in position, release the screwdriver to close the terminal contact. The wire will now be firmly held in place. See [FIGURE 3-2](#) (p. 8).

**NOTE:**

It is not possible to reliably insert more than one solid-core wire into one terminal connector unless the wires are soldered or clamped together. When inserting more than one stranded wire, twist the bare ends together before insertion.

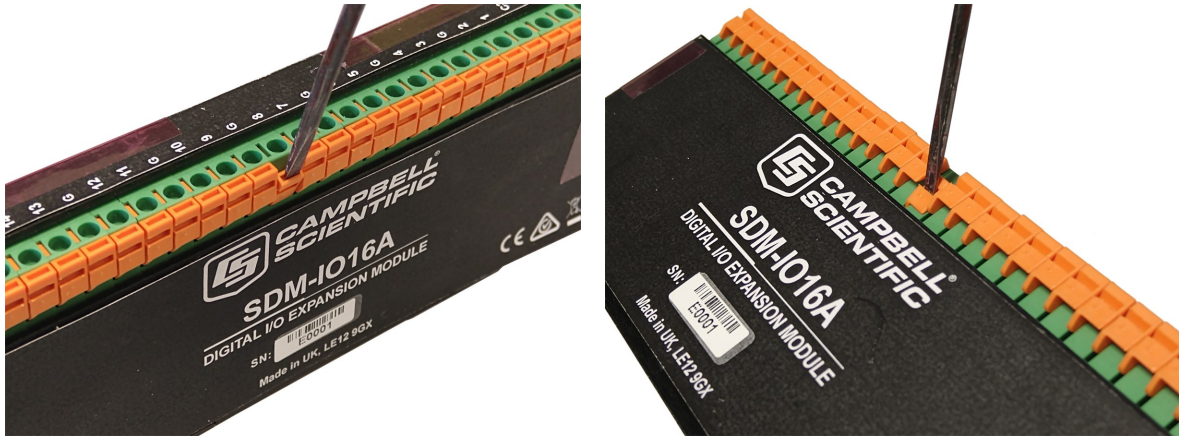

FIGURE 3-2. Use of terminal blocks

## 3.3 Address selection switches

Each SDM module must have a unique address. Address 15 (switch setting F) is reserved for the **SDMTrigger()** instruction. The factory-set address is 00. Table 3-2 (p. 8) shows switch position and the corresponding address. FIGURE 3-3 (p. 9) shows the position of the switch.

Switch Setting	Decimal Address	Base 4 Address
0	0	00
1	1	01
2	2	02
3	3	03
4	4	10
5	5	11
6	6	12
7	7	13
8	8	20

Table 3-2: SDM-IO16A SDM address settings		
Switch Setting	Decimal Address	Base 4 Address
9	9	21
A	10	22
B	11	23
C	12	30
D	13	31
E	14	32
F (reserved)	15	33



FIGURE 3-3. Address selection switch

Each SDM-IO16A must be set to a unique address on the SDM bus, so no two SDM peripherals share the same address.

# 4. Programming the data logger

---

## 4.1 General principles

The [SDMIO16\(\)](#) instruction is used to control operation and configure each I/O terminal of the SDM-IO16A. The different variants of this instruction are described in [SDMIO16\(\) instruction](#) (p. 11).

The general form of the instruction specific to the SDM-IO16A includes:

- Parameters to specify which module to address
- A command code to specify what the module is to do
- Control parameters and pointers to input locations/variables which hold data (either read by the module or used to control the outputs of the module)

The instruction differs from many others in that, rather than addressing a variable number of terminals (using a repetitions parameter), terminals are dealt with in blocks of 1, 4, 8 or 16 terminals at a time. The specific terminal(s) and number to be controlled is implicit in the command code used. This improves the efficiency of programming and reduces the amount of data transferred between the module and data logger via the SDM port.

The module is reconfigured from the controlling program to allow for more demanding applications. In most cases, though, on power-up the I/O terminals of the SDM-IO16A default to input mode, with no switch debounce filtering and measurement of frequency and duty cycle automatically starts for all terminals.

For many input measurements, the controlling program in the data logger is written to ask the SDM-IO16A for measurements of status, duty cycle, or frequency from any channel. The only constraint is it must ask for duty cycle or frequency measurements more frequently than once every 4096 seconds (low-speed mode) and 1024 seconds (high-speed mode) (see [General principles of pulse and frequency measurements](#) (p. 20)).

Where one or more terminals will be used for output, one call of the instruction within the normal program structure is used to set those terminals to either a fixed state, or a state dependent upon a variable.

An instruction is typically included to configure the SDM-IO16A before it is used. Conditions when configuration is needed include:

- Where terminals are used as switch closure inputs (program example 6)
- Where a terminal change of state is used to toggle the I/O line, normally to generate an interrupt to the data logger (program example 7)
- Where the terminal is used as a fixed output (program examples 1 and 2)

See the SDM-IO16A program example on the Campbell Scientific website:

[www.campbellsci.com/downloads/sdm-io16a-program-example](http://www.campbellsci.com/downloads/sdm-io16a-program-example).

The configuration of individual terminals is also changed during normal program operation, if required.

## 4.2 SDMIO16() instruction

The **SDMIO16()** instruction in CRBasic supports all the functions of the SDM-IO16A. An example program for the SDM-IO16A using the **SDMIO16()** instruction is found on the Campbell Scientific website: [www.campbellsci.com/downloads/sdm-io16a-program-example](http://www.campbellsci.com/downloads/sdm-io16a-program-example). This program demonstrates multiple ways to configure the SDM-IO16A for input and output using the **SDMIO16()** instruction.

### Syntax

**SDMIO16** (Destination, IO16Status, SDMAAddress, IO16Cmd, Mode16\_13, Mode12\_9, Mode8\_5, Mode4\_1, Multiplier, Offset)

### Remarks

The terminals on the SDM-IO16A are configured for either input or output. When configured as input, the SDM-IO16A measures the logical state of each terminal, counts pulses, and measures the frequency of and determines the duty cycle of applied signals. It is also possible to make the SDM-IO16A generate an interrupt signal to the data logger when one or more input signals change state. When configured as an output, each terminal is set to 0 or 5 V by the data logger. In addition to being able to drive normal logic level inputs, when an output is set high a 'boost' circuit allows it to source a current of up to 133 mA (short-circuited to ground), allowing direct control of low voltage valves, relays, or other components. Refer to graph **(d) Output voltage versus current output** in [FIGURE 2-1](#) (p. 5) to see the available current at different voltages.

<b>Destination</b>	This parameter is a variable or variable array in which to store the results of the measurement (command codes 1 - 69, 91, 92, 99) or the source value for the command codes (70 - 85, 93 - 98). The variable array for this parameter must be dimensioned to accommodate the number of values returned (or sent) by the instruction.
<b>I016Status</b>	This parameter is used to hold the result of the command issued by the instruction. If the command is successful a 0 is returned; otherwise, the value is incremented by 1 with each failure.
<b>SDMAddress</b>	This parameter defines the address of the SDM-IO16A with which to communicate. Valid SDM addresses are 0 through 14. Address 15 is reserved for the <b>SDMTrigger</b> instruction.
<b>I016Cmd</b>	This parameter is used to set up the SDM-IO16A. See <a href="#">Command codes for the SDMIO16() instruction</a> (p. 14) for a detailed description of the command codes.

## Mode

Each Mode parameter is used to configure a bank of four terminals when a command code 86 through 90 is used (if any other command code is used, enter 0 for the Mode parameters). Mode is entered as a four-digit parameter, where each parameter indicates the setting for a terminal. Terminals are represented from the highest terminal number to the lowest, from left to right (e.g., 16 15 14 13; 12 11 10 9; 8 7 6 5; 4 3 2 1). There are Modes for terminals 16 to 13, 12 to 9, 8 to 5, and 4 to 1. The valid codes are:

Code	Description
0	Output logic low
1	Output logic high
2	Input digital, no debounce filter
3	Input switch closure 3.17 ms (low-speed mode) and 0.7925 ms (high-speed mode) debounce filter
4	Input digital interrupt <sup>1</sup> enabled, no debounce filter
5	Input switch closure interrupt <sup>1</sup> enabled 3.17 ms (low-speed mode) and 0.7925 ms (high-speed mode), debounce filter
6	Undefined
7	Undefined
8	Undefined
9	No change

## Multiplier, Offset

The Multiplier and Offset parameters are each a constant, variable, array, or expression by which to scale the results of the measurement.

<sup>1</sup>Refer to [Using the I/O line to trigger code to run on a data logger](#) (p. 23) for more information on the interrupt function.

## 4.3 SDMCD16AC() instruction

All but the oldest versions of the CR5000 operating system also support the [SDMCD16AC\(\)](#) instruction to control the SDM-IO16A for output mode only. This instruction should only be used if backward compatibility is required, as only [SDMIO16\(\)](#) supports error detection on communications between the module and the data logger.

See the CRBasic Help for more information on this instruction.

**NOTE:**

This cannot be mixed with the [SDMIO16\(\)](#) instruction in the same program.

## 4.4 SDMSpeed() instruction

The [SDMSpeed\(\)](#) instruction is used to change the bit period that the data logger uses to clock the SDM data. Slowing down the clock rate may be necessary when if data transmissions are impaired. Typically, this will only occur when the total length of the cables connecting the data logger and SDM devices is approaching the maximum of 6 m (20 ft).

### Syntax

[SDMSpeed](#) (BitPeriod)

The **BitPeriod** parameter is either an integer or a variable. If the [SDMSpeed\(\)](#) instruction is not in the program, a default bit period is used. If no BitPeriod is specified, the minimum allowable bit period is used. The following table shows the default, minimum allowable, and maximum bit period for each CRBasic data logger.

Data logger	Default bit period	Minimum allowable bit period	Maximum bit period	Resolution
GRANITE series, CR6, CR3000, CR1000X	28.80 $\mu$ sec	10 $\mu$ sec	1 msec	4.3 $\mu$ sec
CR1000, CR800 series	26.04 $\mu$ s	9 $\mu$ s	2 ms	8.68 $\mu$ sec

## 4.5 Command codes for the SDMIO16() instruction

There are approximately one hundred command codes for the **I016Cmd** parameter in the [SDMIO16\(\)](#) instruction. See CRBasic Help for the full list of command codes. Each type of action is generally possible for either a single or block of terminals of various sizes, as discussed in [General principles](#) (p. 10). A summary table of common command codes is shown in [Table 4-2](#) (p. 18). The small number of different types of action allows the commands to be grouped:



**Pulse counting (1 to 23):**

Reads the counts accumulated on the specified terminals since they were last read. The maximum number of counts possible is 65535. If the count has not been read before this maximum is reached, this figure will roll over (from 65535 back to 0) at this point. The count is incremented when there is a low to high transition on the terminal.

**Frequency measurement (24 to 46):**

Reads the average frequency on specified terminals since the last time a frequency command was called. See [General principles of pulse and frequency measurements](#) (p. 20) for a full discussion of the effects of sample rate on frequency of measurement. Generally, the longer the sample rate the higher the resolution. However, the interval between frequency commands for any one terminal must be less than 4096 seconds (low-speed mode) and 1024 seconds (high-speed mode).

**Duty cycle measurement (47 to 69):**

Reads the average duty cycle on the specified terminals since the last duty cycle command for that terminal. See [General principles of pulse and frequency measurements](#) (p. 20) for a full discussion of the effects of sample rate on duty cycle measurement. Generally, the longer the sample rate the higher the resolution. However, the interval between duty cycle commands for any one terminal must be less than 4096 seconds (low-speed mode) and 1024 seconds (high-speed mode). The value output is a number between 0 and 100 that indicates the percentage of time the terminal was high.

<b>Set the terminal debounce time (70 to 85):</b>	Sets the debounce filtering time in multiples of 244 $\mu$ s (low-speed mode) and 61.04 $\mu$ s (high-speed mode) from 0 to 65535 on the specified terminal. On power-up, the default time parameter is set to 0, i.e. no debounce filtering. If debounce filtering is enabled using one of the command codes 86 to 90, this parameter is set to 12, equivalent to a filter time of 3.17 ms (low-speed mode) and 0.7925 ms (high-speed mode). See <a href="#">General principles of pulse and frequency measurements</a> (p. 20) for full details of the operation of this filter and the timing.
<b>Configure the terminals (86 to 90):</b>	Sets the configuration of each terminal using the Mode parameter set from 2 to 5, forming part of the instruction. The options allow setting of output state or input filtering and whether a terminal will cause the I/O line to generate an interrupt pulse to the data logger.
<b>Read the terminal states (91 to 92):</b>	Reads the state of all the terminals into either one or 16 sequential variables. For normal logic input a value of 0 is returned for the low state and a value of 1 is returned for the high state, while for switch closures 0 and 1 relate to closed and open. The current state of all terminals is read, even if some are being used for outputs or frequency inputs.
<b>Set the terminal states (93 to 94):</b>	Sets the pattern of the terminal output state, either from a single location or 16 sequential locations. These commands will only change the state of terminals already set to output (using one of the command codes 86 to 90, 95 or 96). The pattern is stored internally, so if a terminal is subsequently changed from input to output (using command code 95 or 96) the terminal will then change to match that set by an earlier call with command code 93 or 94.
<b>Set the direction (input or output) of the terminals (95 to 96):</b>	Sets the direction of the terminals either from a single location or 16 sequential locations. A value of 1 for a terminal sets it to input and a value of 0 sets it to output. On power-up, terminals default to being inputs. If the direction is set to be an output immediately after power-up the state will be low.

- Set the interrupt mask (97 to 98):** Sets a binary mask across the terminals to define whether a change of state on the terminal (which must also be configured as an input) will generate an interrupt signal to the data logger. When the appropriate mask bit representing the terminal is set to 1 an interrupt will be generated whenever the terminal changes state. Please refer to [Using the I/O line to trigger code to run on a data logger](#) (p. 23) for more details of this function.
- Read module status (99):** Reads back the module operating system signature (which is calculated once at power-up), a number which identifies the operating system version plus two counters. These are a watchdog error counter which is incremented if the module crashes because of a software or hardware failure that required the SDM-IO16A to be reset and a communications error counter which represents the number of times SDM communications between the data logger and SDM-IO16A failed. Both counters have a maximum limit of 255 counts and are reset to zero when this command code is used to read them. This command is only normally used when trying to diagnose problems with the data logging system.
- Set low-speed mode (103):** Sets low-speed mode 4096 Hz sample rate (this is the default at power up).
- Set high-speed mode (104):** Sets high-speed mode 16384 Hz sample rate. This should be executed every scan in case of power failure.

Table 4-2: Common command codes (*in italics*) relative to terminal number and function

		Terminal numbers															
Action	Terminal block size	1	2	3	4	5	6	7	8	9	10	11	12	13	14	15	16
Read counts	1	<i>1</i>	<i>2</i>	<i>3</i>	<i>4</i>	<i>5</i>	<i>6</i>	<i>7</i>	<i>8</i>	<i>9</i>	<i>10</i>	<i>11</i>	<i>12</i>	<i>13</i>	<i>14</i>	<i>15</i>	<i>16</i>
	4	<i>17</i>				<i>18</i>				<i>19</i>				<i>20</i>			
	8	<i>21</i>								<i>22</i>							
	16	<i>23</i>															
Read frequency	1	<i>24</i>	<i>25</i>	<i>26</i>	<i>27</i>	<i>28</i>	<i>29</i>	<i>30</i>	<i>31</i>	<i>32</i>	<i>33</i>	<i>34</i>	<i>35</i>	<i>36</i>	<i>37</i>	<i>38</i>	<i>39</i>
	4	<i>40</i>				<i>41</i>				<i>42</i>				<i>43</i>			
	8	<i>44</i>								<i>45</i>							
	16	<i>46</i>															
Read duty cycle	1	<i>47</i>	<i>48</i>	<i>49</i>	<i>50</i>	<i>51</i>	<i>52</i>	<i>53</i>	<i>54</i>	<i>55</i>	<i>56</i>	<i>57</i>	<i>58</i>	<i>59</i>	<i>60</i>	<i>61</i>	<i>62</i>
	4	<i>63</i>				<i>64</i>				<i>65</i>				<i>66</i>			
	8	<i>67</i>								<i>68</i>							
	16	<i>69</i>															
Set debounce	1	<i>70</i>	<i>71</i>	<i>72</i>	<i>73</i>	<i>74</i>	<i>75</i>	<i>76</i>	<i>77</i>	<i>78</i>	<i>79</i>	<i>80</i>	<i>81</i>	<i>82</i>	<i>83</i>	<i>84</i>	<i>85</i>
Set-up terminals	4	<i>89</i>				<i>88</i>				<i>87</i>				<i>86</i>			
	16	<i>90</i>															
Read state	16	<i>91 or 92</i>															
Set state	16	<i>93 or 94</i>															

Table 4-2: Common command codes ( <i>in italics</i> ) relative to terminal number and function		
Set direct	16	<i>95 or 96</i>
Set int mask	16	<i>97 or 98</i>
Set low-speed mode	16	<i>103</i>
Set high-speed mode	16	<i>104</i>

# Appendix A. General principles of pulse and frequency measurements

---

## A.1 Introduction

It is necessary to understand the general method of input measurements of the SDM-IO16A to understand the limits of frequency and duty cycle resolution.

The microprocessor in the module runs an internal task that reads the status of all 16 terminals at a fixed sample rate of 4096 Hz (low-speed mode) and 16384 Hz (high-speed mode). Changes of state of each terminal from one sample to the next are used to determine the start and end of pulses. This sample frequency determines the resolution and range of the pulse measurements.

## A.2 Frequency and duty cycle measurement range

To guarantee that a pulse is detected, it must remain in either the high or low state longer than the time between samples, which is  $1 / \text{sample rate } \mu\text{s}$ . This sets the upper limit of signal frequency for which pulses are counted or frequencies measured. By implication, the maximum frequency that is measured is with a 50/50 duty cycle signal. If the duty cycle is different from this, the maximum frequency measurable is lower. This maximum frequency, measurable for a signal with a range of duty cycles, is expressed as the minimum of two functions:

$$f_{\text{max}} = \% \text{min} \times \text{sample rate} / 100$$

$$f_{\text{max}} = (100 - \% \text{max}) \times \text{sample rate} / 100$$

Where:

$f_{\text{max}}$  = maximum frequency at a specific duty cycle (Hz)

$\% \text{min}$  = minimum duty cycle in %

$\% \text{max}$  = maximum duty cycle in %

sample rate = 4096 Hz (low-speed mode) and 16384 Hz (high-speed mode)

Consequently, for any given frequency (f) there will be a limit to the maximum and minimum duty cycle measured due to the restriction of the minimum detectable pulse width. Using the same variables defined above,

$$\%min = f \times 100 / \text{sample rate}$$

$$\%max = 100 - \%min$$

Therefore, the lower the frequency, the larger the measurable range of duty cycle.

## A.3 Resolution of frequency measurements

The module measures frequency by counting the number of full signal cycles between requests for measurements by the data logger and measuring the time between the start of the first and end of the last of these cycles. The resolution of a frequency measurement will be dependent on the number of pulses and the resolution of the internal timer (1 / sample rate  $\mu$ s). The resultant resolution is calculated with the following equation:

$$f_{res} = f^2 / (\text{sample rate} \times \text{Int}(t \times f))$$

Where:

$f_{res}$  = resolution in (Hz).

f = actual frequency measured in (Hz).

t = time between frequency measurement commands in (seconds).

Int = a function which returns the truncated integer value

sample rate = 4096 Hz (low-speed mode) and 16384 Hz (high-speed mode).

For example, in low-speed mode reading 1000 Hz at a 0.25 s frequency measurement interval will give a resolution of 0.97 Hz, while at 1 s between measurements the resolution would be 0.25 Hz.

The resolution improves with longer times between frequency measurement commands.

However, the maximum time between measurements is 4096 seconds (low-speed mode) and 1024 seconds (high-speed mode) which is limited by the range of internal counters.

## A.4 Resolution of duty cycle measurements

Duty cycle measurements are made by calculating the proportion of time that a signal is high for all full signal cycles that occur in between two measurement requests by the data logger. The resolution is calculated using the following equation:

$$\%r = 100 \times f / (\text{sample rate} \times \text{Int}(t \times f))$$

Where:

$\%r$  = duty cycle resolution in (%)

$f$  = frequency of the signal in (Hz)

$t$  = time between duty cycle measurement commands in (seconds)

Int = a function which returns the truncated integer value

sample rate = 4096 Hz (low-speed mode) and 16384 Hz (high-speed mode).

For example, in low-speed mode reading the duty cycle of a 1000 Hz signal at 0.25 s intervals will give a resolution of 0.097%, while at 1 second intervals the resolution would be 0.025%.

Duty cycle resolution improves with longer times between duty cycle measurement commands. However, the maximum time between measurements is 4096 seconds (low-speed mode) and 1024 seconds (high-speed mode) which is limited by the range of internal counters.

Although the duty cycle measurement uses the same sample frequency as the frequency measurement technique, it is not dependent on counting or timing a known number of cycles. For this reason, it is capable of sampling and giving accurate duty cycle readings for higher frequency signals. Signals up to 4.000 kHz (low-speed mode) and 16.1 KHz (high-speed mode) are measured without error. Signals of higher frequency will also appear to give accurate measurements. Care should be taken as signals that are exact multiples of the sample frequency, will give completely spurious readings.

## A.5 Debounce filtering

The module is able to digitally filter input signals to prevent false counting of pulses or inaccurate measurement of frequency for signals sources that do not have "clean" digital signals. Such signals are often generated by mechanical switch closures where the contacts bounce on changeover resulting in a signal that, for instance, goes low as the switch closes but then goes high for an instant as the contact bounces, before finally going low again when the switch finally closes properly.

The method of filtering switch bounce is also based on the sample rate. The principle of operation is that when the debounce time parameter is non-zero, an integrator function is enabled for that terminal. Then when the signal is sampled, a counter is either increased or decreased depending on whether the signal is high or low. The counter value ranges between two limits that represent the high or low input states. Only when the counter reaches the opposite extreme limit will a change of state be recognized. This action emulates a traditional resistive capacitive (RC) filter, except that the integrator changes in a linear fashion. The amount by which the counter is changed decreases with increasing size of the debounce timer parameter.



The larger the parameter, the slower the integration counter will change, and the longer it will take for a change of state to be recognized.

This debounce time is the time a signal must stay in the new state before it will be recognized as having changed state. This is the minimum time it takes the internal counter to ramp from one limit to the other, providing the input signal switches cleanly from one state to the other. As with a traditional 'RC' filter, if the signal 'bounces' back to its old state, the integrator will ramp in the opposite direction during the bounce. This means that a new change of state will not be recognized until the filter time has passed plus twice the time period that the signal 'bounces' back to its original state.

For example, a switch that changes state but bounces to its original state for a total of 0.5 ms while changing will, with the default debounce time of 3.17 ms, not be recognized as changing state until 4.17 ms after the initial change. Only one pulse will be counted, though, even if the switch opened and closed several times within that 4.17 ms period.

One consequence of this method of filtering is the maximum frequency measured is affected by the amount of switch bounce. In the example above, it takes 4.17 ms to detect the initial changeover. The next change back to the original state cannot start until the end of this period otherwise the original changeover may not be counted. Assuming the same amount of bounce for all changeovers, the maximum frequency in this example would be  $1/(0.00417 \times 2)$ , which equates to 120 Hz, rather than 158 Hz if there is no bounce (low-speed mode).

The relationship between the minimum debounce time in seconds ( $t_d$ ) and the debounce parameter (n) is:

$$t_d = 1 / \text{sample rate} + n \times 1 / \text{sample rate}$$

The relationship between maximum frequency ( $f_{\text{max}}$ ), debounce time and total switch bounce time (tb) in seconds is:

$$f_{\text{max}} = 1 / (2 \times (t_d + 2 \times t_d))$$

## A.6 Using the I/O line to trigger code to run on a data logger

The SDM-IO16A can be configured, using the terminal setup commands (86 to 90), to generate an "interrupt" signal back to the data logger when input terminals change state. When configured, the SDM-IO16A will pulse its I/O line until the data logger responds by reading the input state of the SDM-IO16A using the **SDMI016()** instruction in a slow sequence with commands 91 or 92.

To use this function, the I/O terminal should be connected to a control terminal on the data logger. In the data logger program the `WaitDigTrig()` instruction, in a slow sequence, can be used to execute a section of specific code in the data logger program when the I/O line is pulsed. That code could simply read the SDM-IO16A port status. It may also trigger sending alarms or recording times of an event. See the program example on the Campbell Scientific website ([www.campbellsci.com/downloads/sdm-io16a-program-example](http://www.campbellsci.com/downloads/sdm-io16a-program-example)) to see a demonstration of how this is done. Example 7 in the sample program demonstrates using the `SDMI016()` instruction (command 91) in combination with the `WaitDigTrig()` instruction in a slow sequence. The example reads the port status and writes that information to a variable. When the I/O line is not pulsing, it switches to a high impedance state, which means that several similar I/O lines, from different modules, may be connected in parallel to the same control terminal on the data logger.

# Limited warranty

---

Products manufactured by Campbell Scientific are warranted by Campbell Scientific to be free from defects in materials and workmanship under normal use and service for twelve months from the date of shipment unless otherwise specified on the corresponding product webpage. See Product Details on the Ordering Information pages at [www.campbellsci.com](http://www.campbellsci.com). Other manufacturer's products, that are resold by Campbell Scientific, are warranted only to the limits extended by the original manufacturer.

Refer to [www.campbellsci.com/terms#warranty](http://www.campbellsci.com/terms#warranty) for more information.

**CAMPBELL SCIENTIFIC EXPRESSLY DISCLAIMS AND EXCLUDES ANY IMPLIED WARRANTIES OF MERCHANTABILITY OR FITNESS FOR A PARTICULAR PURPOSE.** Campbell Scientific hereby disclaims, to the fullest extent allowed by applicable law, any and all warranties and conditions with respect to the Products, whether express, implied or statutory, other than those expressly provided herein.

# Assistance

---

Products may not be returned without prior authorization.

Products shipped to Campbell Scientific require a Returned Materials Authorization (RMA) or Repair Reference number and must be clean and uncontaminated by harmful substances, such as hazardous materials, chemicals, insects, and pests. Please complete the required forms prior to shipping equipment.

Campbell Scientific regional offices handle repairs for customers within their territories. Please see the back page for the Global Sales and Support Network or visit [www.campbellsci.com/contact](http://www.campbellsci.com/contact) to determine which Campbell Scientific office serves your country.

To obtain a Returned Materials Authorization or Repair Reference number, contact your CAMPBELL SCIENTIFIC regional office. Please write the issued number clearly on the outside of the shipping container and ship as directed.

For all returns, the customer must provide a "Statement of Product Cleanliness and Decontamination" or "Declaration of Hazardous Material and Decontamination" form and comply with the requirements specified in it. The form is available from your CAMPBELL SCIENTIFIC regional office. Campbell Scientific is unable to process any returns until we receive this statement. If the statement is not received within three days of product receipt or is incomplete, the product will be returned to the customer at the customer's expense. Campbell Scientific reserves the right to refuse service on products that were exposed to contaminants that may cause health or safety concerns for our employees.

# Safety

---

**DANGER** — MANY HAZARDS ARE ASSOCIATED WITH INSTALLING, USING, MAINTAINING, AND WORKING ON OR AROUND **TRIPODS, TOWERS, AND ANY ATTACHMENTS TO TRIPODS AND TOWERS SUCH AS SENSORS, CROSSARMS, ENCLOSURES, ANTENNAS, ETC.** FAILURE TO PROPERLY AND COMPLETELY ASSEMBLE, INSTALL, OPERATE, USE, AND MAINTAIN TRIPODS, TOWERS, AND ATTACHMENTS, AND FAILURE TO HEED WARNINGS, INCREASES THE RISK OF DEATH, ACCIDENT, SERIOUS INJURY, PROPERTY DAMAGE, AND PRODUCT FAILURE. TAKE ALL REASONABLE PRECAUTIONS TO AVOID THESE HAZARDS. CHECK WITH YOUR ORGANIZATION'S SAFETY COORDINATOR (OR POLICY) FOR PROCEDURES AND REQUIRED PROTECTIVE EQUIPMENT PRIOR TO PERFORMING ANY WORK.

Use tripods, towers, and attachments to tripods and towers only for purposes for which they are designed. Do not exceed design limits. Be familiar and comply with all instructions provided in product manuals. Manuals are available at [www.campbellsci.com](http://www.campbellsci.com). You are responsible for conformance with governing codes and regulations, including safety regulations, and the integrity and location of structures or land to which towers, tripods, and any attachments are attached. Installation sites should be evaluated and approved by a qualified engineer. If questions or concerns arise regarding installation, use, or maintenance of tripods, towers, attachments, or electrical connections, consult with a licensed and qualified engineer or electrician.

## General

- Protect from over-voltage.
- Protect electrical equipment from water.
- Protect from electrostatic discharge (ESD).
- Protect from lightning.
- Prior to performing site or installation work, obtain required approvals and permits. Comply with all governing structure-height regulations.
- Use only qualified personnel for installation, use, and maintenance of tripods and towers, and any attachments to tripods and towers. The use of licensed and qualified contractors is highly recommended.
- Read all applicable instructions carefully and understand procedures thoroughly before beginning work.
- Wear a **hardhat** and **eye protection**, and take **other appropriate safety precautions** while working on or around tripods and towers.
- **Do not climb** tripods or towers at any time, and prohibit climbing by other persons. Take reasonable precautions to secure tripod and tower sites from trespassers.
- Use only manufacturer recommended parts, materials, and tools.

## Utility and Electrical

- **You can be killed** or sustain serious bodily injury if the tripod, tower, or attachments you are installing, constructing, using, or maintaining, or a tool, stake, or anchor, come in **contact with overhead or underground utility lines**.
- Maintain a distance of at least one-and-one-half times structure height, 6 meters (20 feet), or the distance required by applicable law, **whichever is greater**, between overhead utility lines and the structure (tripod, tower, attachments, or tools).
- Prior to performing site or installation work, inform all utility companies and have all underground utilities marked.
- Comply with all electrical codes. Electrical equipment and related grounding devices should be installed by a licensed and qualified electrician.
- Only use power sources approved for use in the country of installation to power Campbell Scientific devices.

## Elevated Work and Weather

- Exercise extreme caution when performing elevated work.
- Use appropriate equipment and safety practices.
- During installation and maintenance, keep tower and tripod sites clear of un-trained or non-essential personnel. Take precautions to prevent elevated tools and objects from dropping.
- Do not perform any work in inclement weather, including wind, rain, snow, lightning, etc.

## Maintenance

- Periodically (at least yearly) check for wear and damage, including corrosion, stress cracks, frayed cables, loose cable clamps, cable tightness, etc. and take necessary corrective actions.
- Periodically (at least yearly) check electrical ground connections.

## Internal Battery

- Be aware of fire, explosion, and severe-burn hazards.
- Misuse or improper installation of the internal lithium battery can cause severe injury.
- Do not recharge, disassemble, heat above 100 °C (212 °F), solder directly to the cell, incinerate, or expose contents to water. Dispose of spent batteries properly.

WHILE EVERY ATTEMPT IS MADE TO EMBODY THE HIGHEST DEGREE OF SAFETY IN ALL CAMPBELL SCIENTIFIC PRODUCTS, THE CUSTOMER ASSUMES ALL RISK FROM ANY INJURY RESULTING FROM IMPROPER INSTALLATION, USE, OR MAINTENANCE OF TRIPODS, TOWERS, OR ATTACHMENTS TO TRIPODS AND TOWERS SUCH AS SENSORS, CROSSARMS, ENCLOSURES, ANTENNAS, ETC.



## Global Sales & Support Network

*A worldwide network to help meet your needs*



### Campbell Scientific regional offices

#### Australia

*Location:* Garbutt, QLD Australia  
*Phone:* 61.7.4401.7700  
*Email:* [info@campbellsci.com.au](mailto:info@campbellsci.com.au)  
*Website:* [www.campbellsci.com.au](http://www.campbellsci.com.au)

#### Brazil

*Location:* São Paulo, SP Brazil  
*Phone:* 11.3732.3399  
*Email:* [vendas@campbellsci.com.br](mailto:vendas@campbellsci.com.br)  
*Website:* [www.campbellsci.com.br](http://www.campbellsci.com.br)

#### Canada

*Location:* Edmonton, AB Canada  
*Phone:* 780.454.2505  
*Email:* [dataloggers@campbellsci.ca](mailto:dataloggers@campbellsci.ca)  
*Website:* [www.campbellsci.ca](http://www.campbellsci.ca)

#### China

*Location:* Beijing, P. R. China  
*Phone:* 86.10.6561.0080  
*Email:* [info@campbellsci.com.cn](mailto:info@campbellsci.com.cn)  
*Website:* [www.campbellsci.com.cn](http://www.campbellsci.com.cn)

#### Costa Rica

*Location:* San Pedro, Costa Rica  
*Phone:* 506.2280.1564  
*Email:* [info@campbellsci.cc](mailto:info@campbellsci.cc)  
*Website:* [www.campbellsci.cc](http://www.campbellsci.cc)

#### France

*Location:* Vincennes, France  
*Phone:* 0033.0.1.56.45.15.20  
*Email:* [info@campbellsci.fr](mailto:info@campbellsci.fr)  
*Website:* [www.campbellsci.fr](http://www.campbellsci.fr)

#### Germany

*Location:* Bremen, Germany  
*Phone:* 49.0.421.460974.0  
*Email:* [info@campbellsci.de](mailto:info@campbellsci.de)  
*Website:* [www.campbellsci.de](http://www.campbellsci.de)

#### India

*Location:* New Delhi, DL India  
*Phone:* 91.11.46500481.482  
*Email:* [info@campbellsci.in](mailto:info@campbellsci.in)  
*Website:* [www.campbellsci.in](http://www.campbellsci.in)

#### South Africa

*Location:* Stellenbosch, South Africa  
*Phone:* 27.21.8809960  
*Email:* [sales@campbellsci.co.za](mailto:sales@campbellsci.co.za)  
*Website:* [www.campbellsci.co.za](http://www.campbellsci.co.za)

#### Spain

*Location:* Barcelona, Spain  
*Phone:* 34.93.2323938  
*Email:* [info@campbellsci.es](mailto:info@campbellsci.es)  
*Website:* [www.campbellsci.es](http://www.campbellsci.es)

#### Thailand

*Location:* Bangkok, Thailand  
*Phone:* 66.2.719.3399  
*Email:* [info@campbellsci.asia](mailto:info@campbellsci.asia)  
*Website:* [www.campbellsci.asia](http://www.campbellsci.asia)

#### UK

*Location:* Shepshed, Loughborough, UK  
*Phone:* 44.0.1509.601141  
*Email:* [sales@campbellsci.co.uk](mailto:sales@campbellsci.co.uk)  
*Website:* [www.campbellsci.co.uk](http://www.campbellsci.co.uk)

#### USA

*Location:* Logan, UT USA  
*Phone:* 435.227.9120  
*Email:* [info@campbellsci.com](mailto:info@campbellsci.com)  
*Website:* [www.campbellsci.com](http://www.campbellsci.com)