

# PS150/CH150

## 12 V Charging Regulators



# Table of Contents

---

*PDF viewers: These page numbers refer to the printed version of this document. Use the PDF reader bookmarks tab for links to specific sections.*

|  |           |
|--|-----------|
| <b>1. Introduction.....</b>                            | <b>1</b>  |
| <b>2. Precautions and Tips .....</b>                   | <b>2</b>  |
| <b>3. QuickStart .....</b>                             | <b>3</b>  |
| 3.1 Connecting Power .....                             | 5         |
| 3.1.1 Solar Panel .....                                | 5         |
| 3.1.2 AC/DC Power .....                                | 6         |
| 3.2 Plug In the Battery .....                          | 7         |
| 3.3 Hook Up Power to Data Logger.....                  | 9         |
| 3.4 Turn On the Charging Source .....                  | 9         |
| 3.5 Turn On Power to the Data Logger.....              | 9         |
| 3.6 LED Indicator .....                                | 9         |
| <b>4. Specifications .....</b>                         | <b>10</b> |
| 4.1 Specifications .....                               | 10        |
| 4.2 Battery Packs.....                                 | 11        |
| 4.3 Charging Sources .....                             | 11        |
| <b>5. Operational Overview.....</b>                    | <b>13</b> |
| <b>6. Charging Details .....</b>                       | <b>14</b> |
| 6.1 Charging Algorithm .....                           | 14        |
| 6.2 Maximum Power Point Tracking .....                 | 15        |
| <b>7. A100 Null Modem Adapter .....</b>                | <b>15</b> |
| <b>8. A105 Additional 12 V Terminals Adapter .....</b> | <b>17</b> |
| <b>9. References .....</b>                             | <b>17</b> |

## **Figures**

|   |    |
|---|----|
| 1-1. PS150 .....  | 1  |
| 3-1. The PS150 connected to a CR1000 and AC power.....    | 4  |
| 3-2. The PS150 connected to a CR1000 and solar panel..... | 4  |
| 3-3. CH150 connected to BP24 battery pack and CR1000..... | 5  |
| 3-4. Solar panel connections on PS150 .....               | 6  |
| 3-5. AC power connections on PS150 .....                  | 7  |
| 3-6. Lift latch up on PS150.....                          | 8  |
| 3-7. Slide PS150 lid off.....                             | 8  |
| 3-8. Wiring harness plugged into battery connector.....   | 9  |
| 5-1. CH/PS150 schematic.....                              | 13 |

|      |  |    |
|------|--|----|
| 6-1. | 70 W solar panel I – V and power characteristics ..... | 15 |
| 7-1. | A100 connector .....                                   | 16 |
| 7-2. | Installing the A100.....                               | 16 |
| 7-3. | A100 mounting screw .....                              | 17 |
| 8-1. | A105 adapter .....                                     | 17 |

# ***PS150/CH150 12 V Charging Regulators***

---

## **1. Introduction**

The PS150 is a 12 VDC power supply that includes a rechargeable 7 Ah valve-regulated lead-acid (VRLA) battery and charging regulator. The CH150 is a charging regulator for an external rechargeable 12 V VRLA battery such as the BP12 or BP24 offered by Campbell Scientific. Charging power for these charging regulators is typically supplied by an unregulated solar panel, AC/AC transformer, or AC/DC converter.

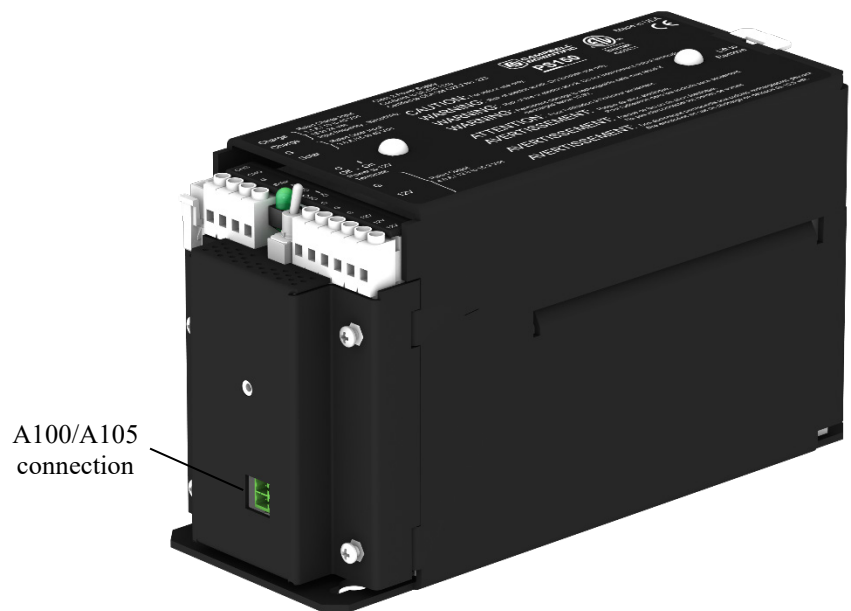

*FIGURE 1-1. PS150*

The PS150/CH150 are smart chargers that provide charging with temperature compensation for optimal charging and battery life. A maximum power point tracking algorithm is incorporated for solar inputs to maximize available solar charging resources.

The PS150/CH150 are compatible with the A100 null-modem adapter and the A105 adapter for additional 12 V output terminals. The A100 Null Modem Adapter connects and powers two Campbell Scientific peripherals via two CS I/O 9-pin connectors configured as a null modem. This is useful in linking different communications technologies; e.g., telephone to radio, at sites that do not have a data logger. The A105 adapter may be used to provide additional 12 V and ground terminals where the power supply is used to power several devices. See Section 7, *A100 Null Modem Adapter* (p. 15), and 8, *A105 Additional 12 V Terminals Adapter* (p. 17), for more information.

The PS150/CH150 charging regulators are termed series regulators, because the regulators are placed in series between the charging source and the load. As batteries become closer to fully charged, series regulators reduce the current drawn from the charging source, to where the charging source may be

completely unloaded if full-charge is reached. While this unloading of the charging source is acceptable for solar panels, AC/AC transformers and AC/DC converters, it is undesirable for wind turbines because of the resulting free spinning when unloaded. Consequently, series charging regulators, including the PS150/CH150, should not be used to regulate the output of wind turbines without the inclusion of a way to load the turbine when the batteries require little or no charging current.

The PS150/CH150 chargers have several safety features intended to protect the charging source, battery, charger, and load devices. Both the **SOLAR – G** and **CHARGE – CHARGE** input terminals incorporate hardware current limits and polarity reversal protection. There is a 5 Amp slow-blow fuse in series with the **CHARGE – CHARGE** inputs in the event of a catastrophic AC/AC or AC/DC charging source failure. If the 5 Amp load is sustained long enough, the device will open permanently. There is a 4.65 A self-resetting circuit breaker in series with the **12 V** output terminals of the charger in the event of an output load fault. The PS150/CH150 incorporate battery reversal protection, which is catastrophic for most chargers. ESD and surge protection are incorporated on all inputs and outputs of the PS150/CH150.

## 2. Precautions and Tips

---

**DANGER**      **Risk of electric shock. Use only in a dry location, such as indoors or in a weather-sealed enclosure.**

---



---

**DANGER**      **Risk of fire or electric shock. Do not inter-connect output terminals.**

---



---

**WARNING**      **Permanent damage to rechargeable cells may result if discharged below 10.5 V.**

---

Under normal charging conditions with sealed VRLA batteries, hydrogen and oxygen gasses are produced in relatively small quantities, most of which later recombines back into water. Aggressive overcharging produces excess hydrogen and oxygen gasses, resulting in gas venting by means of a pressure activated valve. Hydrogen gas emitted from VRLA batteries must not be allowed to accumulate, as it could form an explosive mixture. Fortunately, hydrogen gas is difficult to contain in anything but a metal or glass enclosure.

---

**DANGER**      **Never put VRLA batteries in an enclosure that does not allow emitted hydrogen gas to be dispersed.**

---

VRLA batteries are capable of providing high surge currents. The 12 V output terminals of the PS150/CH150 are fused with a 4.65 A self-resettable circuit breaker, but there is no fusing for inadvertent bridging of the battery terminals. Accidental shorting of battery terminals by metallic objects, such as

watchbands, can cause severe burns due to rapid heating and is also a fire hazard.

VRLA battery manufacturers state that “Heat Kills Batteries”. While the PS150/CH150 can operate from –40 to 60 °C, optimum battery life is achieved with battery operating temperatures ranging from 5 to 35 °C<sup>i</sup>, per manufacturer’s recommendations<sup>1</sup>. The PS150/CH150 offer temperature compensation of the battery charging voltage based on a temperature measurement inside the PS150/CH150 cases. The CH150 internal temperature measurement likely will not accurately represent battery temperature for charge voltage compensation unless the battery is in close proximity to the CH150.

With rechargeable batteries, a charge → discharge → re-charge event is termed a cycle. In general, the most important factor for the service life of a battery is depth of discharge<sup>1</sup>. For example, decreasing the depth of each discharge from 100% to 50% approximately doubles the number of useful cycles available from the battery<sup>1</sup>.

---

**WARNING**

**Leaving a lead-acid battery in a discharged state for prolonged periods of time results in the undesirable growth of large sulfate crystals (sulfation) that are detrimental to battery performance.**

---

VRLA batteries self-discharge at approximately 3% of rated capacity per month at room temperature<sup>1</sup>. A 3% of rated capacity per month self-discharge results in 100% discharge in approximately 33 months (≈ 3 years) for a battery stored at room temperature. Self-discharge increasing with increasing storage temperature.

---

**NOTE**

Periodic recharging of stored batteries every few months is recommended to prevent irreversible sulfation due to prolonged time in a discharged state.

---

### 3. QuickStart

The PS150/CH150 modules are designed to handle extreme conditions. The modules have been designed with mounting holes on one-inch centers for mounting to a standard Campbell Scientific enclosure back plate — see the enclosure manual for mounting suggestions. See FIGURE 3-1 through FIGURE 3-3 for typical enclosure installations using a PS150/CH150.

---

<sup>i</sup> Genesis Application Manual – Genesis NP and NPX Series US-NP-AM-002, June 2006.

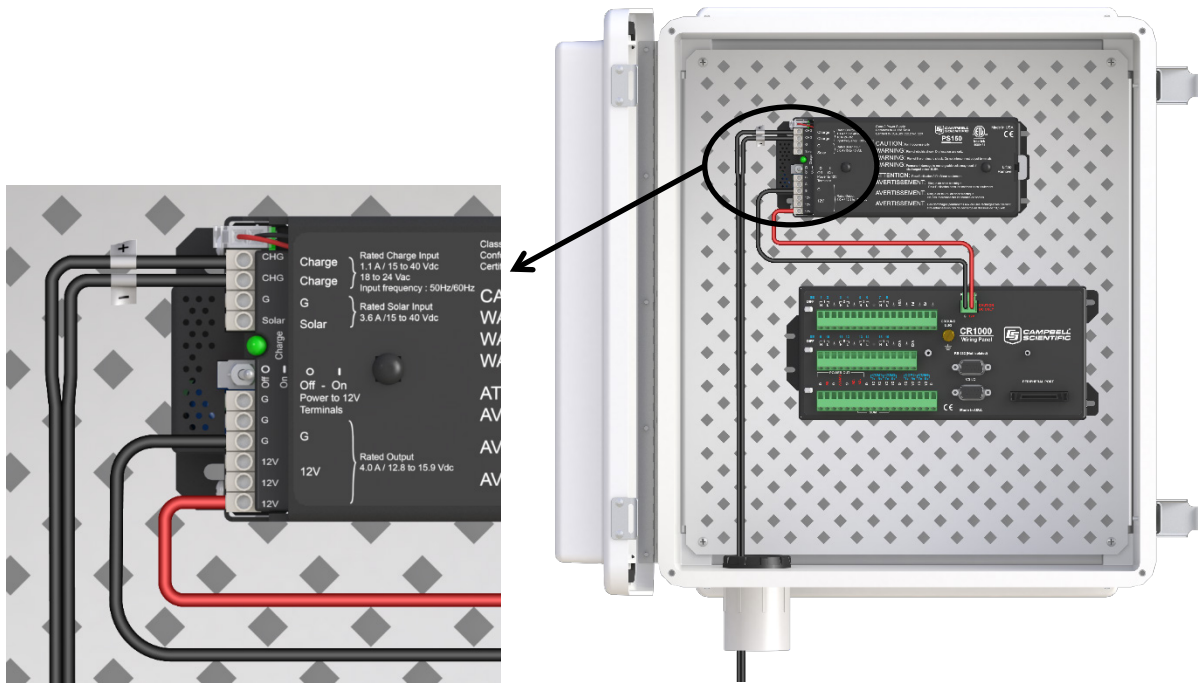

FIGURE 3-1. The PS150 connected to a CR1000 and AC power

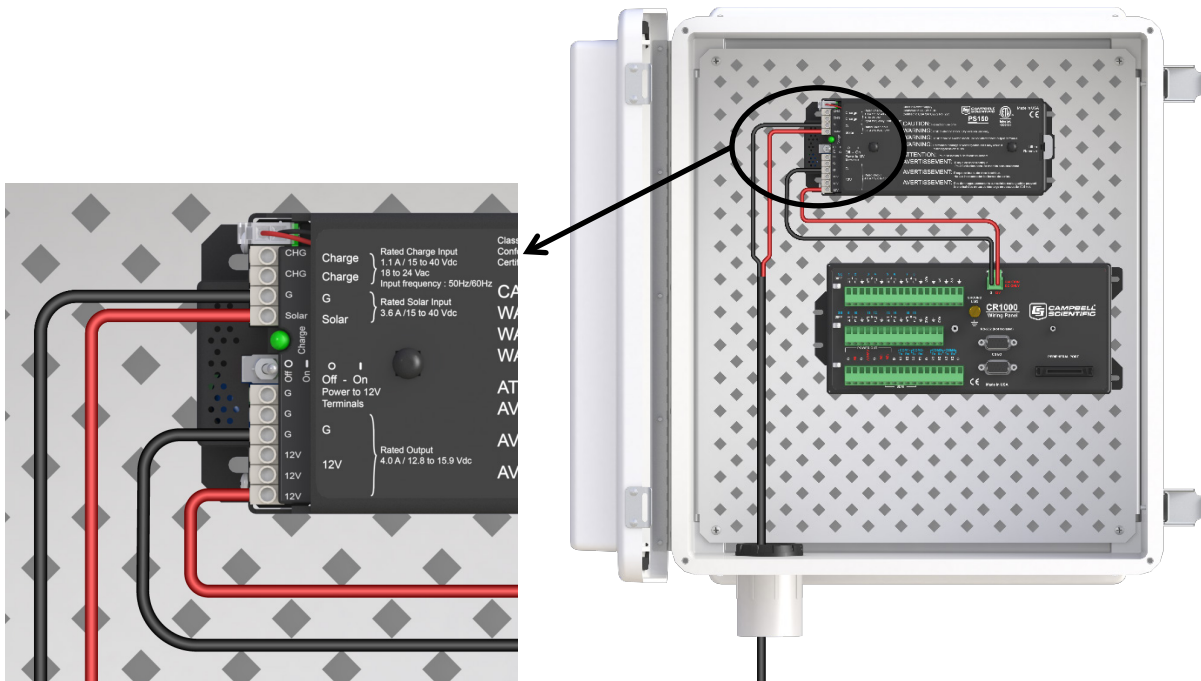

FIGURE 3-2. The PS150 connected to a CR1000 and solar panel

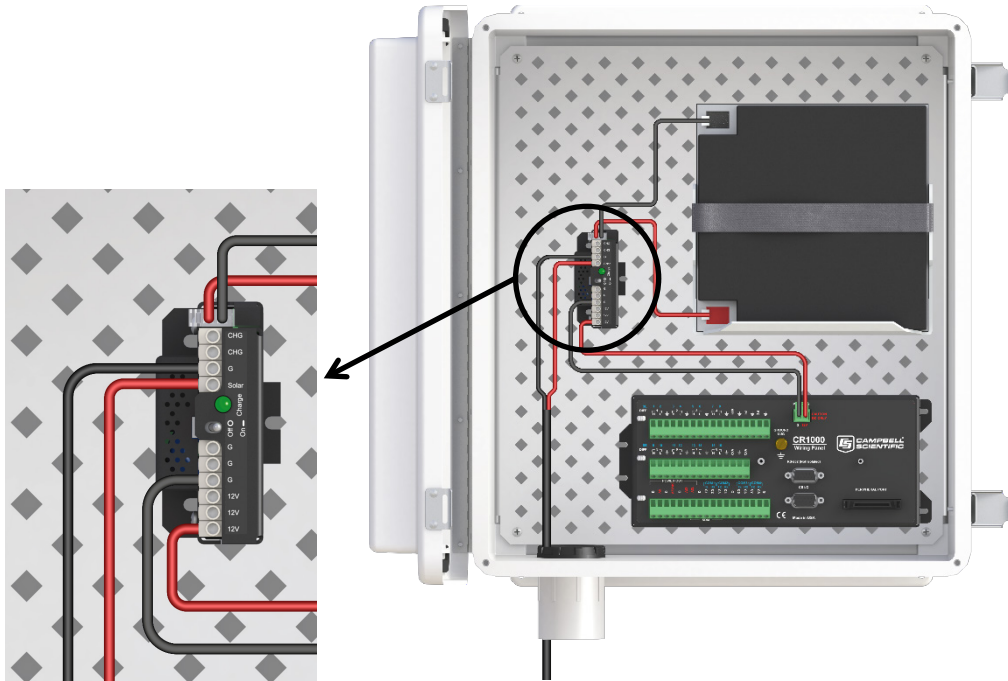

FIGURE 3-3. CH150 connected to BP24 battery pack and CR1000

### 3.1 Connecting Power

**WARNING**

Although the power supply and battery are low voltage, they do have the ability to supply a high current and could potentially heat up a metal ring, watch band, or bracelet enough to burn skin or melt metal when shorted. Remove rings, watches, or bracelets before hooking up power and connecting a battery.

The CH/PS150 allow both solar and AC power to be simultaneously connected.

Toggle the power supply switch to **Off** before connecting power to the power supply.

**NOTE**

The switch on the CH/PS150 only controls power going to the **12V** and **G** terminal blocks. The battery is continuously charged regardless of the switch setting as long as a charging voltage is present.

#### 3.1.1 Solar Panel

**WARNING**

To prevent sparking while wiring up the solar panel, either lay the solar panel face down on its packing box or cover it with something opaque to block the sunlight while wiring up the panel.



Connect the black (negative) wire from the solar panel to the terminal block marked **G** that is directly adjacent to the **SOLAR** terminal block. Connect the red (positive) wire from an unregulated solar panel to the terminal block marked **SOLAR**. See FIGURE 3-4.

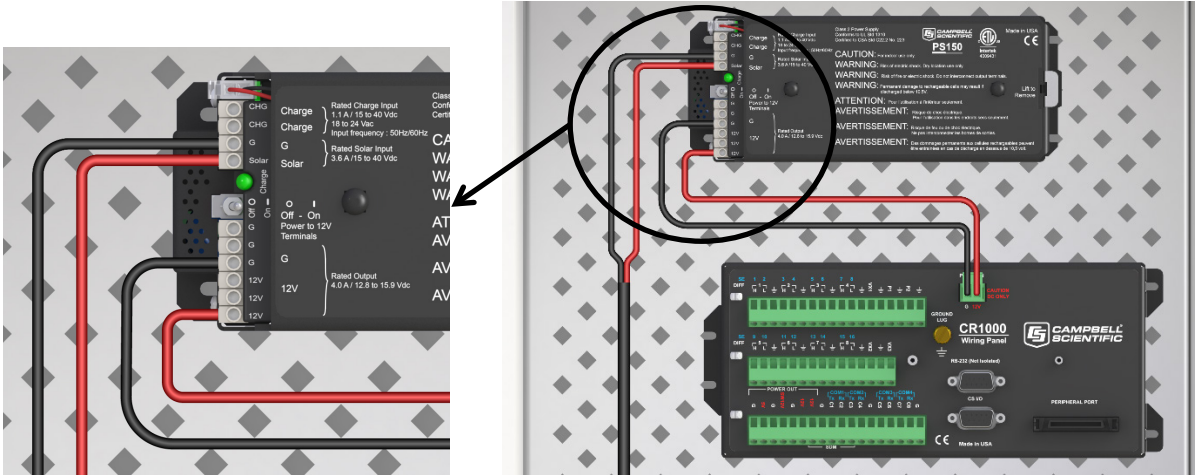

FIGURE 3-4. Solar panel connections on PS150

### 3.1.2 AC/DC Power

Double check the input voltages coming in to the charger/regulator with a volt meter.

**AC** Input Voltage: 14 to 24 VAC RMS

**DC** Input Voltage: 15 to 40 VDC

#### WARNING

**Exceeding the voltages listed above will damage the power supply.**

Disconnect the primary side of the AC/DC power before connecting wires to the PS150.

Connect the secondary power supply wires to the two terminal blocks marked **CHG**. There is no polarity on the **CHG** terminal blocks, so it does not matter which wire goes to which **CHG** terminal block, but make sure there is only ONE wire per block. See FIGURE 3-5.

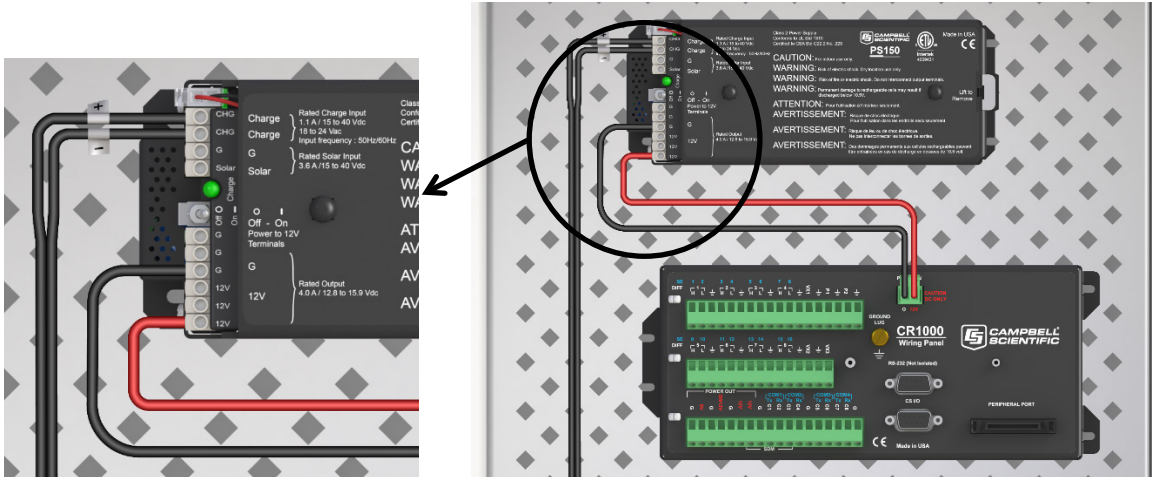

FIGURE 3-5. AC power connections on PS150

### 3.2 Plug In the Battery

The battery used with the PS150 is shipped inside of the PS150 case if the power supply is NOT installed inside an enclosure. If the PS150 is mounted inside an enclosure, then the battery will be located separately packed in one of the packing boxes. This is done to minimize any damage that could occur if the power supply should get loose from its mounts inside the enclosure during shipment. The battery will NOT be plugged into the PS150. This is done to minimize discharging the battery.

To remove the lid from the PS150, pull up on the PS150 lid latch and slide the lid off as shown in FIGURE 3-6 and FIGURE 3-7.

#### WARNING

**Do not remove the tape holding the battery wiring harness to the top of the battery! The tape is used to keep the battery wiring harness out of the way of the rubber bumpers on the inside of the lid.**

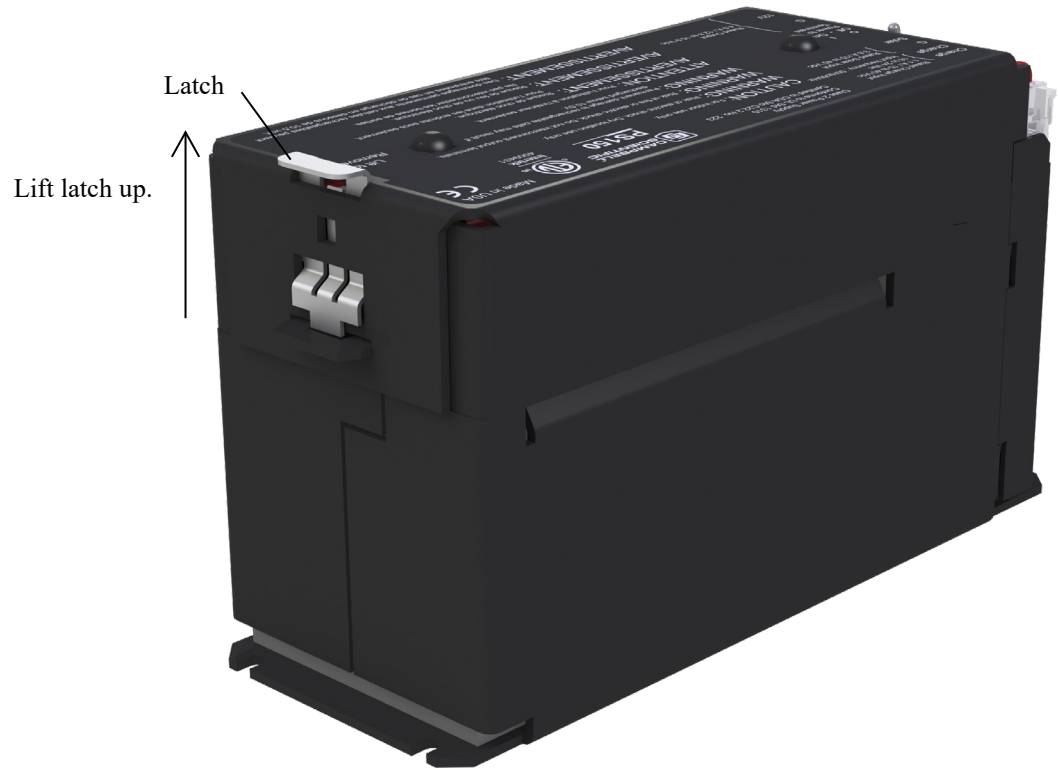

FIGURE 3-6. Lift latch up on PS150



FIGURE 3-7. Slide PS150 lid off

Plug the battery wire into the battery wire terminal indicated in FIGURE 3-7. This connector is polarized and will only allow the mating connector to be plugged in one way. Push the connector all the way in until it locks in place.

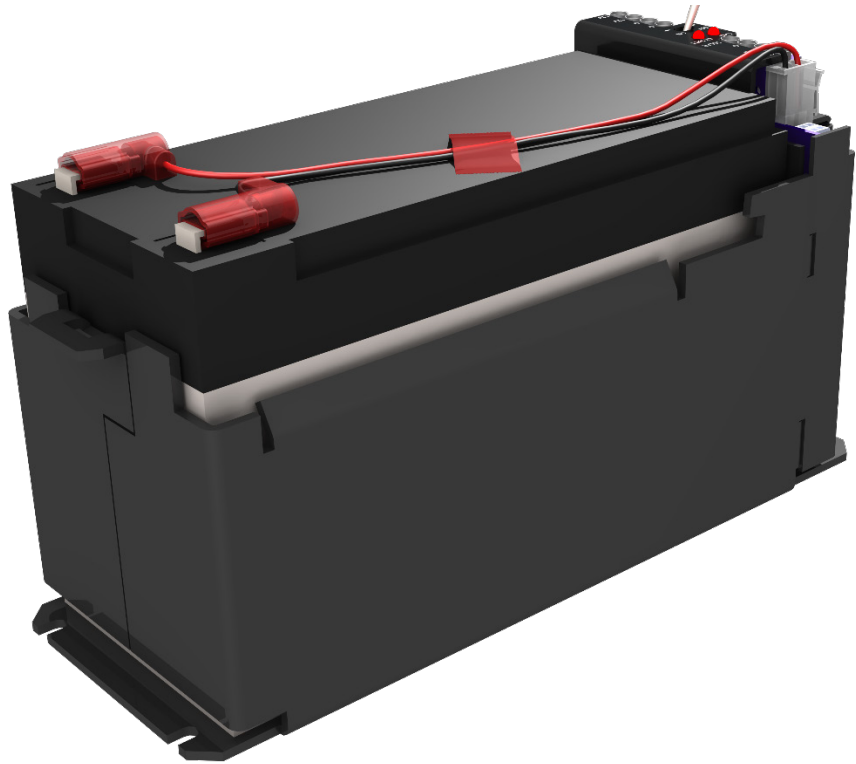

FIGURE 3-8. Wiring harness plugged into battery connector

### 3.3 Hook Up Power to Data Logger

Both the PS150 and the CH150 come with a 1-foot black wire attached to one of the **G** terminal blocks and a 1-foot red wire attached to one of the **12V** terminal blocks. Attach the red wire from the power supply to the data logger 2-Pin Screw Terminal Plug Connector marked **12V**. Attach the black wire from the power supply to the data logger 2-Pin Screw Terminal Plug Connector marked **G**.

### 3.4 Turn On the Charging Source

Turn on the power going to the charging source or uncover the solar panel. The green **Charge** LED will flash approximately once a second if all incoming connections are correct and there is an adequate charging voltage present.

### 3.5 Turn On Power to the Data Logger

Toggle the switch on the PS150/CH150 supply to **On**. Verify voltage to the data logger with a volt meter, display, or connect to the data logger with a laptop to make sure the data logger is running correctly.

### 3.6 LED Indicator

The green **Charge** LED will flash approximately once a second if all incoming connections are correct and there is an adequate charging voltage present.

## 4. Specifications

### 4.1 Specifications

|   |   |
|---|---|
| <b>(CHARGE - CHARGE terminals)<br/>AC or DC Source:</b>   | AC – (18 to 24) VRMS internally limited to 1.2 ARMS<br>DC – (16 to 40) VDC internally limited to 0.85 A   |
| <b>(SOLAR - <math>\frac{1}{2}</math> terminals)<br/>Solar Panel or Other DC Source<sup>1</sup>:</b> | 15 to 40 VDC<br>Maximum Charging Current:<br>4.0 A typical; 3.2 to 4.9 A depending upon individual charger  |
| <b>Battery Charging</b>   | FLOAT Charging: $V_{batt}(T) = 13.65 - (24 \text{ mV}) \times (T - 25) + (0.24 \text{ mV}) \times (T - 25)^2$ , where T is temperature in degrees Celsius<br>$\pm 1\%$ Accuracy on charging voltage over $-40$ to $60$ °C range |
| <b>Operational Temperature Range<sup>2</sup>:</b>   | $-40$ to $60$ °C  |
| <b>Power Out (+12 terminals)</b>  |   |
| <b>Voltage:</b>   | Unregulated 12 V from Battery<br>4.65 A solid-state circuit breaker   |
| <b>Quiescent Current</b>  |   |
| <b>No Charge Source Present:</b>  | 160 $\mu$ A at 13.7 VDC   |
| <b>No Battery Connected:</b>  | 930 $\mu$ A at 30 volt input voltage (AC or DC)   |
| <b>Rated UL Class 2 Power Supply</b>  |   |
| <b>Physical Specifications</b>  |   |
| <b>PS150:</b>   | 10.6 cm (4.2 in) tall, 19.3 cm (7.5 in) long, 7.6 cm (3 in) wide  |
| <b>CH150:</b>   | 10.0 cm (3.9 in) tall, 7.5 cm (3 in) long, 3.7 cm (1.5 in) wide   |
| <b>Compliance:</b>  | View compliance documents applicable to the PS150 or CH150 at <a href="http://www.campbellsci.com/ps150">www.campbellsci.com/ps150</a> or <a href="http://www.campbellsci.com/ch150">www.campbellsci.com/ch150</a> .            |

<sup>1</sup> Battery voltages below 8.7 V may result in  $< 3.0$  A current limit because of foldback current limit.

<sup>2</sup> VRLA battery manufacturers state that “heat kills batteries” and recommend operating batteries  $\leq 50$  °C.

## 4.2 Battery Packs

| Battery Pack Model  | Amp-Hour Capacity (Ah) | *Operating Temperature Range (°C)         | Battery Family       |
|---|------------------------|---|----------------------|
| PS150   | 7                      | Charge: -15 to 50<br>Discharge: -20 to 60 | EnerSys/Genesis      |
| BP12  | 12                     | Charge: -15 to 50<br>Discharge: -20 to 60 | EnerSys/Genesis      |
| BP24  | 24                     | Charge: -15 to 50<br>Discharge: -20 to 60 | EnerSys/Genesis      |
| BP84  | 84                     | -40 to +71                                | Concorde Sun Xtender |
| * Battery specifications shown are from the manufacturer. The PS150/CH150 contains charging algorithms that optimize battery charging over the range of -40 to 50 °C. Battery usage outside of manufacturer specifications could have unknown effects on the life of the battery. |                        |   |                      |

### WARNING

**Battery life is shortened if the battery is allowed to discharge below 11.5 V.**

## 4.3 Charging Sources

| Campbell Scientific Solar Panels |        |        |        |
|----------------------------------|--------|--------|--------|
|                                  | SP10   | SP20   | SP50   |
| <b>Peak Power</b>                | 10 W   | 20 W   | 50 W   |
| <b>Voltage @ Peak Power</b>      | 16.8 V | 16.8 V | 17.5 V |
| <b>Current @ Peak Power</b>      | 0.59 A | 1.19 A | 3.9 A  |

Notes:

1. Specifications assume a 1 kilowatt per square meter illumination and a solar panel temperature of 25 °C (77 °F).
2. Individual panels may vary up to 10%.
3. The output panel voltage increases as the panel temperature decreases, which is in the same direction as the recommended VRLA battery charging voltage change with temperature.
4. Higher latitudes and less sun hours during winter months might require a larger panel than what is required to keep the battery charged during the summer.

**24 VDC Power Supply with Interchangeable Blades**

|                              |   |
|------------------------------|---|
| <b>Input Voltage:</b>        | 100 – 240 VAC                                 |
| <b>Input Frequency:</b>      | 47 – 63 Hz                                    |
| <b>Output Voltage:</b>       | 24 VDC  |
| <b>Output Current (max):</b> | 1.67 A  |
| <b>Protection:</b>           | Unit will auto-recover upon removal of fault. |
| <b>UL Approval:</b>          | UL60950-1 2 <sup>nd</sup> Edition             |

Unit has interchangeable blades. Unit ships with US/Canada plug installed.

For international orders, order an International Plug Set for international blades. International blade selection contains blades for Australia/New Zealand, UK, Europe/South America, Korea, Argentina, China, & India/South Africa.

**AC/DC DIN Rail Mount Power Adapter (24 V 3.8 A NEC Class 2 Power Supply Kit)**

|                         |                                |
|-------------------------|--------------------------------|
| <b>Input Voltage:</b>   | 85 – 240 VAC or 90 – 350 VDC   |
| <b>Input Frequency:</b> | 45 – 65 Hz                     |
| <b>Output Voltage:</b>  | 24 VDC                         |
| <b>Output Current:</b>  | 3.8 A (–25 to 60 °C)           |
| <b>Protection:</b>      | 3.15 A internal slow-blow fuse |
| <b>Approval:</b>        | ETL Listed for US and Canada   |

**NOTE**

Both of the recommended chargers have DC voltage output which can be used on either the **CHARGE/CHARGE** or **SOLAR/G** terminal blocks. Maximum input charging current on the **CHARGE/CHARGE** terminal blocks is limited to 1.1 A. Maximum input charging current on the **SOLAR/G** terminal blocks is limited to 3.6 A.

**CHARGE/CHARGE** terminal blocks have no polarity. Power wires from the charging source can be connected in any fashion. The PS150/CH150 will only float charge a battery with power connected to the **CHARGE/CHARGE** terminal blocks which is fine when using an AC/DC charging source.

**SOLAR/G** terminal blocks do have a polarity that must be followed when wiring up either of the AC/DC devices. Positive wire goes to the terminal block marked **SOLAR**. Negative wire goes to the terminal block marked **G**. Higher power throughput makes this an attractive option. It will float charge a battery, but it will also try to quick charge as well depending on the needs of the battery.

## 5. Operational Overview

A simplified schematic of the CH/PS150 charging regulator is illustrated in FIGURE 5-1. A 12-V 7Amp-hr rechargeable battery is included with the PS150, whereas the user provides the rechargeable battery for the CH150. See Section 4.2, *Battery Packs (p. 11)*, for rechargeable batteries offered for the CH150 by Campbell Scientific.

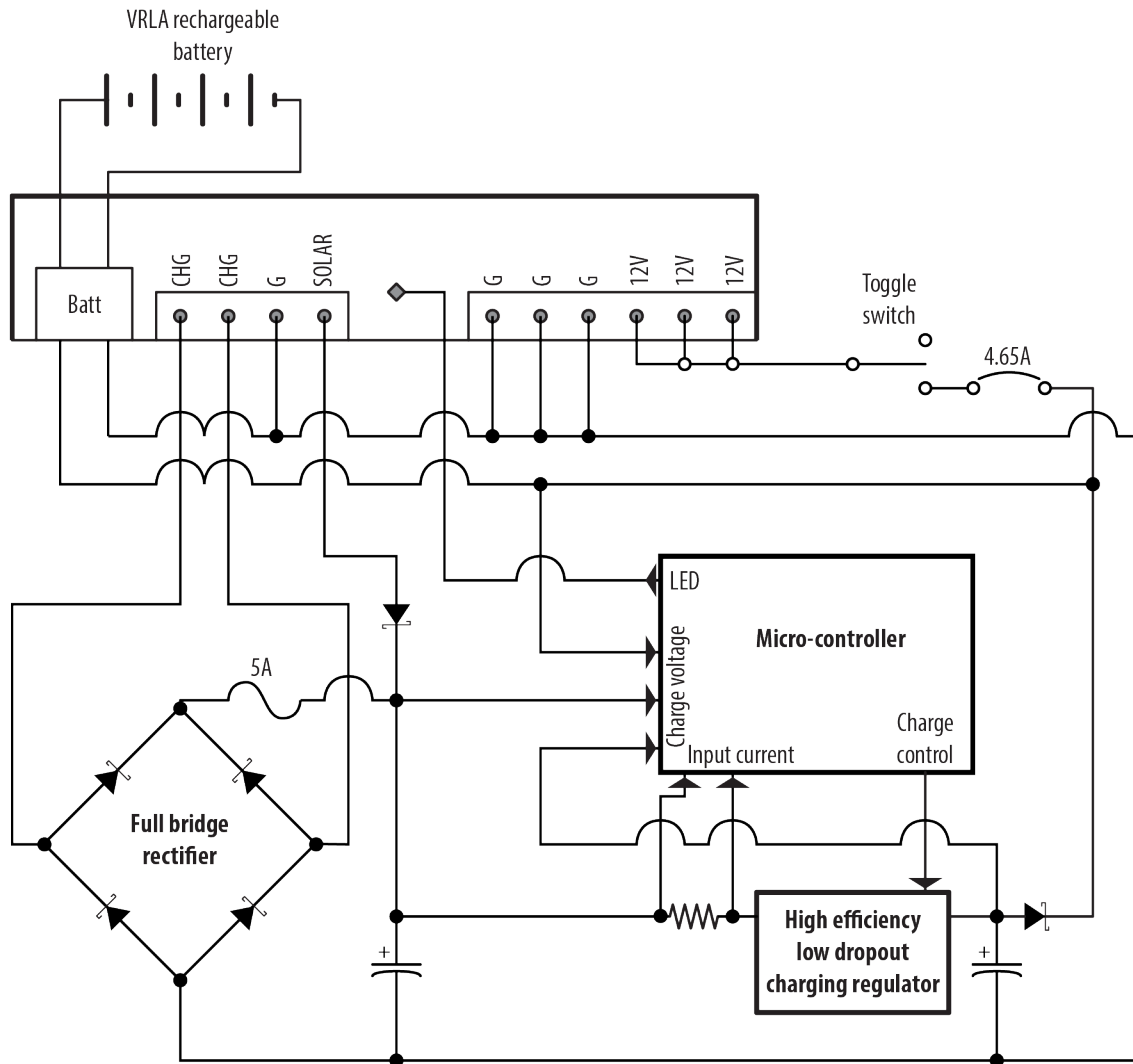

FIGURE 5-1. CH/PS150 schematic

Charging power for the PS150/CH150 is typically supplied by an unregulated solar panel, AC/AC transformer, or AC/DC converter. The **CHARGE – CHARGE** terminals are connected to a full bridge rectifier, accommodating either AC or DC voltages from a charge source. Because of the rectifier, polarity does not matter when connecting sources to the **CHARGE – CHARGE** input terminals. In order to protect AC/AC or AC/DC sources when charging discharged batteries, the **CHARGE – CHARGE** input terminals offer an approximately 1.1 amps DC (1.2 A RMS) current limit. The **SOLAR – G** input terminals are intended for connection to solar panels, or



other high-current DC sources. Polarity definitely matters on the DC only **SOLAR – G** input terminals, with positive connected to **SOLAR** and the return or negative connected to **G**, with reversal protection included. The **SOLAR – G** input terminals have an input current limit of approximately 3.6 amps, making the PS150/CH150 well suited for 70 watt or smaller solar panels. The PS150/CH150 can be simultaneously powered from both the **CHARGE – CHARGE** and **SOLAR – G** input terminals, as the internal diodes will route power from the source with the highest input voltage. This allows for an AC mains powered application with a solar panel for back-up. If the reverse is needed – solar power as the primary supply and AC as the secondary supply – then a solar panel should be used with a 24 VDC output and an AC, or AC to DC, source with a voltage output less than the solar panel voltage.

An AC/DC converter charge source could be connected to either the **CHARGE – CHARGE** input terminals or the **SOLAR – G** input terminals. The best input terminals to use with a given AC/DC converter should be based on the converter output current capability. For example, the **CHARGE – CHARGE** input terminals provide a current limit of 1.1 A on the charging source. Whereas the **SOLAR – G** input terminals have a fixed 3.6 A typical current limit, providing faster battery charging for a charge source that can deliver up to 3.6 A current without damage.

The **SOLAR – G** terminals are optimal for solar panels because of the high-current charging capability when solar resources are available. A Maximum Power Point Tracking algorithm is also utilized when the PS150/CH150 detects the charging source is connected to the **SOLAR** input.

The +12V output terminals are intended to power a data logger and any peripherals. Power to these output terminals is controlled by a toggle switch, with the total output current limited by a 4.65 A solid-state circuit breaker (see Section 4.1, *Specifications (p. 10)*). The A105 Additional 12 V Terminals Adapter may be used to provide extra 12 V and ground terminals where the power supply is used to power several devices, noting that the hold current limit on the 4.65 A solid-state circuit breaker still applies (see Section 8, *A105 Additional 12 V Terminals Adapter (p. 17)*).

## 6. Charging Details

### 6.1 Charging Algorithm

The PS150/CH150 offers both Continuous and Solar charging inputs. The Continuous charging input has a maximum value of 1.1 A to help protect AC/AC transformers and AC/DC converters. The 3.6 A typical current limit of the PS150/CH150 Solar charging input is well suited for 70 W solar panels. Typical Continuous charging inputs would be AC/AC transformers or AC/DC converters in which a charge voltage is continuously applied except for line power outages.

The PS150/CH150 uses a float charging algorithm for either the Continuous or Solar charging inputs. This charging method can charge a battery indefinitely without overcharging a battery.

## 6.2 Maximum Power Point Tracking

The current and power versus voltage for a 70 W solar panel are illustrated in FIGURE 6-1. As can be seen from the figure, a Maximum Power Point of operation exists for solar panels. Adjusting the load on the solar panel so it operates at this Maximum Power Point is referred to as Maximum Power Point Tracking (MPPT). MPPT is beneficial when insufficient power is available from the charge source, which is the case during current limited charging. The somewhat noisy charging current and voltage during the initial current limited charging stage is due to the MPPT algorithm of the PS150/CH150 searching for the maximum power point of the associated solar panel.

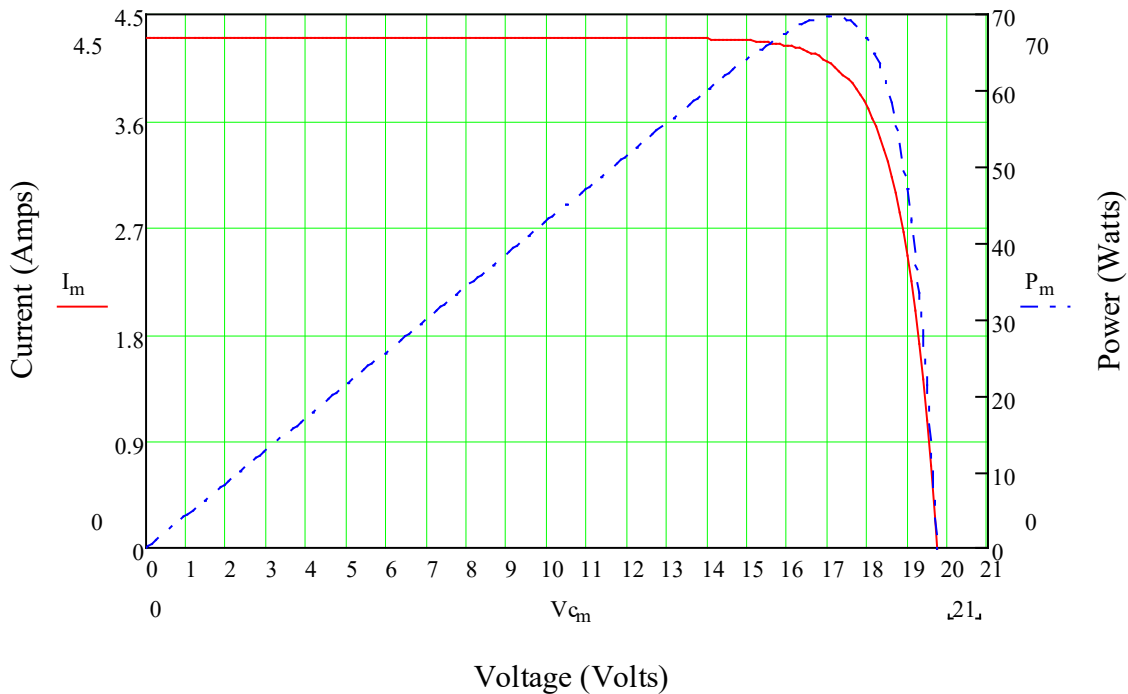

FIGURE 6-1. 70 W solar panel  $I - V$  and power characteristics

## 7. A100 Null Modem Adapter

The A100 adapter has two 9-pin CS I/O ports with a null modem between them. The ports are used to connect two 9-pin devices (such as modems or RF radios) that would normally be connected to the CS I/O port of a Campbell Scientific data logger. The charger supplies 12 VDC and 5 VDC to the appropriate pins on the connector for powering the connected devices. This functionality is required in a station where a data logger will not be present, such as a phone-to-RF base station. The A100 cannot be used as a null modem between two RS-232 devices.

The A100 mounts directly to the CH150 to receive power. Align the green connector inside the A100 (FIGURE 7-1) with the receptacle on the CH150 and press the A100 into place (FIGURE 7-2). Secure the A100 by tightening the screw on the front of the A100 (FIGURE 7-3).

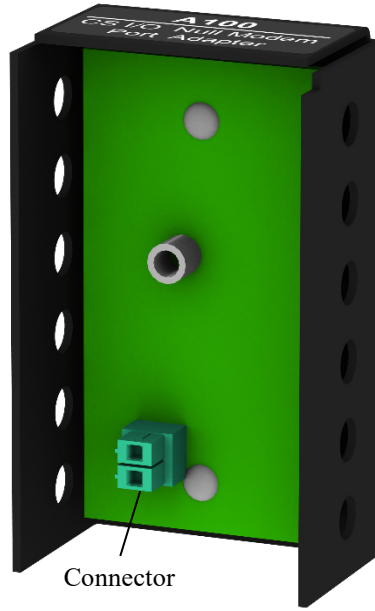

FIGURE 7-1. A100 connector

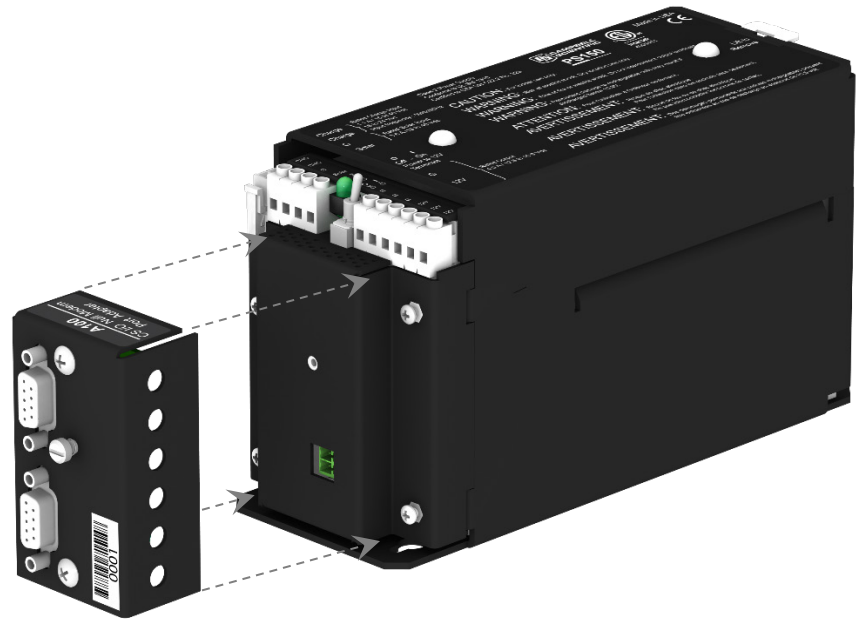

FIGURE 7-2. Installing the A100

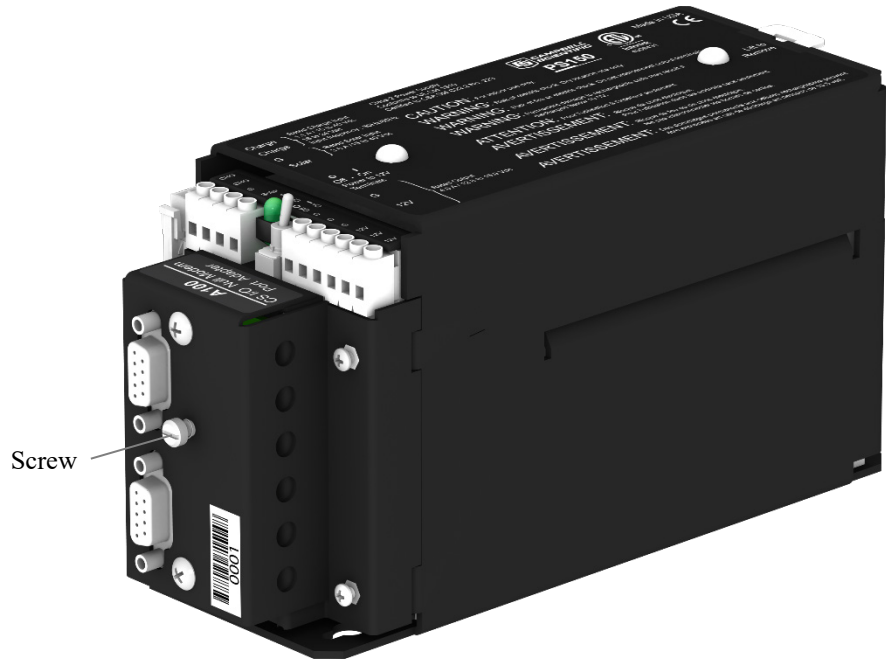

FIGURE 7-3. A100 mounting screw

## 8. A105 Additional 12 V Terminals Adapter

The A105 adapter adds four 12 V terminals and four ground terminals to a PS150/CH150 charging regulator. The extra terminals make it easier to wire multiple continuously powered 12 VDC devices to the power supply.

The A105 shares the same form factor as the A100. Refer to Section 7, *A100 Null Modem Adapter* (p. 15), for information on how to attach the A105 to the PS150.



FIGURE 8-1. A105 adapter

## 9. References

1 – Genesis Application Manual – Genesis NP and NPX Series US-NP-AM-002, June 2006.

# ***Limited Warranty***

---

Products manufactured by Campbell Scientific are warranted by Campbell Scientific to be free from defects in materials and workmanship under normal use and service for five years from the date of shipment unless otherwise specified on the corresponding product webpage. See Product Details on the Ordering Information pages at [www.campbellsci.com](http://www.campbellsci.com). Other manufacturer's products, that are resold by Campbell Scientific, are warranted only to the limits extended by the original manufacturer.

Refer to [www.campbellsci.com/terms#warranty](http://www.campbellsci.com/terms#warranty) for more information.

**CAMPBELL SCIENTIFIC EXPRESSLY DISCLAIMS AND EXCLUDES ANY IMPLIED WARRANTIES OF MERCHANTABILITY OR FITNESS FOR A PARTICULAR PURPOSE. Campbell Scientific hereby disclaims, to the fullest extent allowed by applicable law, any and all warranties and conditions with respect to the Products, whether express, implied or statutory, other than those expressly provided herein.**

# Assistance

---

Products may not be returned without prior authorization.

Products shipped to Campbell Scientific require a Returned Materials Authorization (RMA) or Repair Reference number and must be clean and uncontaminated by harmful substances, such as hazardous materials, chemicals, insects, and pests. Please complete the required forms prior to shipping equipment.

Campbell Scientific regional offices handle repairs for customers within their territories. Please see the back page for the Global Sales and Support Network or visit [www.campbellsci.com/contact](http://www.campbellsci.com/contact) to determine which Campbell Scientific office serves your country.

To obtain a Returned Materials Authorization or Repair Reference number, contact your CAMPBELL SCIENTIFIC regional office. Please write the issued number clearly on the outside of the shipping container and ship as directed.

For all returns, the customer must provide a “Statement of Product Cleanliness and Decontamination” or “Declaration of Hazardous Material and Decontamination” form and comply with the requirements specified in it. The form is available from your CAMPBELL SCIENTIFIC regional office. Campbell Scientific is unable to process any returns until we receive this statement. If the statement is not received within three days of product receipt or is incomplete, the product will be returned to the customer at the customer’s expense. Campbell Scientific reserves the right to refuse service on products that were exposed to contaminants that may cause health or safety concerns for our employees.

# Safety

---

**DANGER — MANY HAZARDS ARE ASSOCIATED WITH INSTALLING, USING, MAINTAINING, AND WORKING ON OR AROUND TRIPODS, TOWERS, AND ANY ATTACHMENTS TO TRIPODS AND TOWERS SUCH AS SENSORS, CROSSARMS, ENCLOSURES, ANTENNAS, ETC. FAILURE TO PROPERLY AND COMPLETELY ASSEMBLE, INSTALL, OPERATE, USE, AND MAINTAIN TRIPODS, TOWERS, AND ATTACHMENTS, AND FAILURE TO HEED WARNINGS, INCREASES THE RISK OF DEATH, ACCIDENT, SERIOUS INJURY, PROPERTY DAMAGE, AND PRODUCT FAILURE. TAKE ALL REASONABLE PRECAUTIONS TO AVOID THESE HAZARDS. CHECK WITH YOUR ORGANIZATION'S SAFETY COORDINATOR (OR POLICY) FOR PROCEDURES AND REQUIRED PROTECTIVE EQUIPMENT PRIOR TO PERFORMING ANY WORK.**

Use tripods, towers, and attachments to tripods and towers only for purposes for which they are designed. Do not exceed design limits. Be familiar and comply with all instructions provided in product manuals. Manuals are available at [www.campbellsci.com](http://www.campbellsci.com). You are responsible for conformance with governing codes and regulations, including safety regulations, and the integrity and location of structures or land to which towers, tripods, and any attachments are attached. Installation sites should be evaluated and approved by a qualified engineer. If questions or concerns arise regarding installation, use, or maintenance of tripods, towers, attachments, or electrical connections, consult with a licensed and qualified engineer or electrician.

## General

- Protect from over-voltage.
- Protect electrical equipment from water.
- Protect from electrostatic discharge (ESD).
- Protect from lightning.
- Prior to performing site or installation work, obtain required approvals and permits. Comply with all governing structure-height regulations.
- Use only qualified personnel for installation, use, and maintenance of tripods and towers, and any attachments to tripods and towers. The use of licensed and qualified contractors is highly recommended.
- Read all applicable instructions carefully and understand procedures thoroughly before beginning work.
- Wear a **hardhat** and **eye protection**, and take **other appropriate safety precautions** while working on or around tripods and towers.
- **Do not climb** tripods or towers at any time, and prohibit climbing by other persons. Take reasonable precautions to secure tripod and tower sites from trespassers.
- Use only manufacturer recommended parts, materials, and tools.

## Utility and Electrical

- **You can be killed** or sustain serious bodily injury if the tripod, tower, or attachments you are installing, constructing, using, or maintaining, or a tool, stake, or anchor, come in **contact with overhead or underground utility lines**.
- Maintain a distance of at least one-and-one-half times structure height, 6 meters (20 feet), or the distance required by applicable law, **whichever is greater**, between overhead utility lines and the structure (tripod, tower, attachments, or tools).
- Prior to performing site or installation work, inform all utility companies and have all underground utilities marked.
- Comply with all electrical codes. Electrical equipment and related grounding devices should be installed by a licensed and qualified electrician.
- Only use power sources approved for use in the country of installation to power Campbell Scientific devices.

## Elevated Work and Weather

- Exercise extreme caution when performing elevated work.
- Use appropriate equipment and safety practices.
- During installation and maintenance, keep tower and tripod sites clear of un-trained or non-essential personnel. Take precautions to prevent elevated tools and objects from dropping.
- Do not perform any work in inclement weather, including wind, rain, snow, lightning, etc.

## Maintenance

- Periodically (at least yearly) check for wear and damage, including corrosion, stress cracks, frayed cables, loose cable clamps, cable tightness, etc. and take necessary corrective actions.
- Periodically (at least yearly) check electrical ground connections.

## Internal Battery

- Be aware of fire, explosion, and severe-burn hazards.
- Misuse or improper installation of the internal lithium battery can cause severe injury.
- Do not recharge, disassemble, heat above 100 °C (212 °F), solder directly to the cell, incinerate, or expose contents to water. Dispose of spent batteries properly.

WHILE EVERY ATTEMPT IS MADE TO EMBODY THE HIGHEST DEGREE OF SAFETY IN ALL CAMPBELL SCIENTIFIC PRODUCTS, THE CUSTOMER ASSUMES ALL RISK FROM ANY INJURY RESULTING FROM IMPROPER INSTALLATION, USE, OR MAINTENANCE OF TRIPODS, TOWERS, OR ATTACHMENTS TO TRIPODS AND TOWERS SUCH AS SENSORS, CROSSARMS, ENCLOSURES, ANTENNAS, ETC.



## Global Sales & Support Network

A worldwide network to help meet your needs



### Campbell Scientific Regional Offices

#### Australia

**Location:** Garbutt, QLD Australia  
**Phone:** 61.7.4401.7700  
**Email:** [info@campbellsci.com.au](mailto:info@campbellsci.com.au)  
**Website:** [www.campbellsci.com.au](http://www.campbellsci.com.au)

#### Brazil

**Location:** São Paulo, SP Brazil  
**Phone:** 11.3732.3399  
**Email:** [vendas@campbellsci.com.br](mailto:vendas@campbellsci.com.br)  
**Website:** [www.campbellsci.com.br](http://www.campbellsci.com.br)

#### Canada

**Location:** Edmonton, AB Canada  
**Phone:** 780.454.2505  
**Email:** [dataloggers@campbellsci.ca](mailto:dataloggers@campbellsci.ca)  
**Website:** [www.campbellsci.ca](http://www.campbellsci.ca)

#### China

**Location:** Beijing, P. R. China  
**Phone:** 86.10.6561.0080  
**Email:** [info@campbellsci.com.cn](mailto:info@campbellsci.com.cn)  
**Website:** [www.campbellsci.com.cn](http://www.campbellsci.com.cn)

#### Costa Rica

**Location:** San Pedro, Costa Rica  
**Phone:** 506.2280.1564  
**Email:** [info@campbellsci.com](mailto:info@campbellsci.com)  
**Website:** [www.campbellsci.com](http://www.campbellsci.com)

#### France

**Location:** Vincennes, France  
**Phone:** 0033.0.1.56.45.15.20  
**Email:** [info@campbellsci.fr](mailto:info@campbellsci.fr)  
**Website:** [www.campbellsci.fr](http://www.campbellsci.fr)

#### Germany

**Location:** Bremen, Germany  
**Phone:** 49.0.421.460974.0  
**Email:** [info@campbellsci.de](mailto:info@campbellsci.de)  
**Website:** [www.campbellsci.de](http://www.campbellsci.de)

#### India

**Location:** New Delhi, DL India  
**Phone:** 91.11.46500481.482  
**Email:** [info@campbellsci.in](mailto:info@campbellsci.in)  
**Website:** [www.campbellsci.in](http://www.campbellsci.in)

#### South Africa

**Location:** Stellenbosch, South Africa  
**Phone:** 27.21.8809960  
**Email:** [sales@campbellsci.co.za](mailto:sales@campbellsci.co.za)  
**Website:** [www.campbellsci.co.za](http://www.campbellsci.co.za)

#### Spain

**Location:** Barcelona, Spain  
**Phone:** 34.93.2323938  
**Email:** [info@campbellsci.es](mailto:info@campbellsci.es)  
**Website:** [www.campbellsci.es](http://www.campbellsci.es)

#### Thailand

**Location:** Bangkok, Thailand  
**Phone:** 66.2.719.3399  
**Email:** [info@campbellsci.asia](mailto:info@campbellsci.asia)  
**Website:** [www.campbellsci.asia](http://www.campbellsci.asia)

#### UK

**Location:** Shepshed, Loughborough, UK  
**Phone:** 44.0.1509.601141  
**Email:** [sales@campbellsci.co.uk](mailto:sales@campbellsci.co.uk)  
**Website:** [www.campbellsci.co.uk](http://www.campbellsci.co.uk)

#### USA

**Location:** Logan, UT USA  
**Phone:** 435.227.9120  
**Email:** [info@campbellsci.com](mailto:info@campbellsci.com)  
**Website:** [www.campbellsci.com](http://www.campbellsci.com)