

# P2546A, P2546C, and P2546D

Anemometers



# Table of contents

---

<b>1. Introduction</b> .....	<b>1</b>
<b>2. Precautions</b> .....	<b>1</b>
<b>3. Initial inspection</b> .....	<b>1</b>
<b>4. QuickStart</b> .....	<b>2</b>
<b>5. Overview</b> .....	<b>5</b>
<b>6. Specifications</b> .....	<b>6</b>
6.1 Calibration .....	7
6.2 Accuracy .....	7
6.3 Output signal .....	8
6.3.1 P2546A switching characteristics .....	8
6.3.2 P2546C output signal .....	8
6.3.3 P2546D output signal .....	8
6.4 Environmental .....	9
6.5 Physical .....	9
<b>7. Installation</b> .....	<b>9</b>
7.1 Siting .....	9
7.2 Mount the sensor .....	10
7.3 Wiring .....	11
7.4 Programming .....	13
<b>8. Troubleshooting and maintenance</b> .....	<b>15</b>
8.1 Troubleshooting .....	15
8.2 Maintenance .....	15
<b>9. References</b> .....	<b>16</b>
<b>Appendix A. Importing Short Cut code into CRBasic Editor</b> .....	<b>17</b>
<b>Appendix B. Example programs</b> .....	<b>18</b>
B.1 P2546A programs .....	18
B.2 P2546C programs .....	21
B.3 P2546D program .....	23

# 1. Introduction

---

The P2546A, P2546C, and P2546D are Class 1 anemometers often used for wind speed resource assessment and wind turbine power performance monitoring. The P2546A includes a reed switch that produces a switch closure output signal. The P2546C contains a coil that produces a low-level ac output signal. The P2546D uses an electronic switching current to produce a high-frequency signal. Our data loggers measure the output signal and convert the signal to engineering units (mph, m/s, knots).

**NOTE:**

This manual provides information only for CRBasic data loggers. For retired Edlog data logger support of the P2546A, see an older manual at [www.campbellsci.com/old-manuals](http://www.campbellsci.com/old-manuals) .

## 2. Precautions

---

- READ AND UNDERSTAND the [Safety](#) section at the end of this manual.
- The anemometers are precision instruments. Please handle them with care.
- Danger — Use extreme care when working near overhead electrical wires. Check for overhead wires before mounting the anemometer or before raising a tower.

## 3. Initial inspection



---

- Upon receipt of the anemometer, inspect the packaging and contents for damage. File damage claims with the shipping company. Immediately check package contents against the shipping documentation. Contact Campbell Scientific about any discrepancies.
- The model number and cable length are printed on a label at the connection end of the cable. Check this information against the shipping documents to ensure the expected product and cable length are received.
- Each anemometer is shipped with a MEASNET calibration certificate that contains information concerning where the anemometer was calibrated, the calibration procedure used, the calibration equation obtained, and the serial number of the anemometer. Cross

check the serial number in the calibration certificate against the serial number on the anemometer to ensure that the given sensitivity value corresponds to your sensor.

## 4. QuickStart

---

A video that describes data logger programming using *Short Cut* is available at: [www.campbellsci.com/videos/cr1000x-data-logger-getting-started-program-part-3](http://www.campbellsci.com/videos/cr1000x-data-logger-getting-started-program-part-3) . *Short Cut* is an easy way to program your data logger to measure the sensor and assign data logger wiring terminals. *Short Cut* is available as a download on [www.campbellsci.com](http://www.campbellsci.com) . It is included in installations of *LoggerNet*, *RTDAQ*, or *PC400*. The following procedure also describes programming with *Short Cut*.

### NOTE:

The P2546C and P2546D are currently not in *Short Cut*. Therefore, they must be programmed using CRBasic (see [Programming](#) (p. 13), [P2546C programs](#) (p. 21)), or [P2546D program](#) (p. 23).

1. Open *Short Cut* and click **Create New Program**.
2. Double-click the data logger model.

- In the **Available Sensors and Devices** box, type P2546 or find the sensor in the **Sensors > Meteorological > Wind Speed & Direction** folder. Double-click **P2546A Wind Speed Sensor**. The wind speed defaults to meters/second. This can be changed by clicking the **Wind Speed** box and selecting one of the other options. If you want to use the MEASNET calibration, select the **Calibrated** check box, and enter the multiplier and offset provided on the *MEASNET Calibration Certificate* shipped with your sensor.

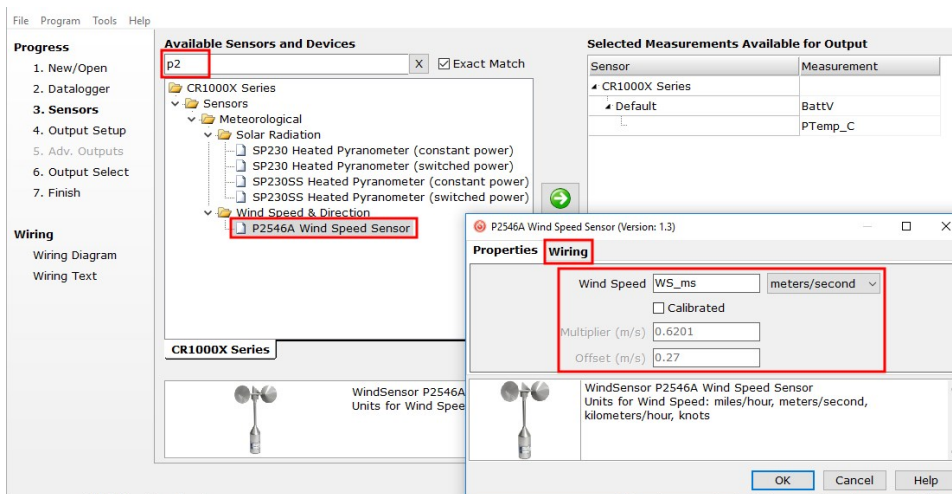

- Click on the **Wiring** tab to see how the sensor is to be wired to the data logger. Click **OK** after wiring the sensor.

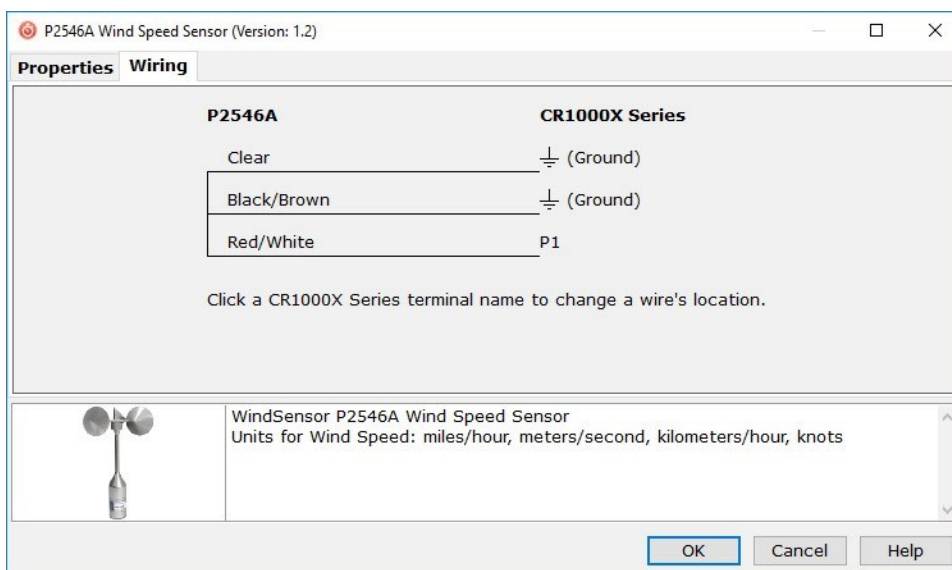

- Repeat steps three and four for other sensors. Click **Next**.

- In **Output Setup**, type the scan rate, meaningful table names, and **Data Output Storage Interval**.

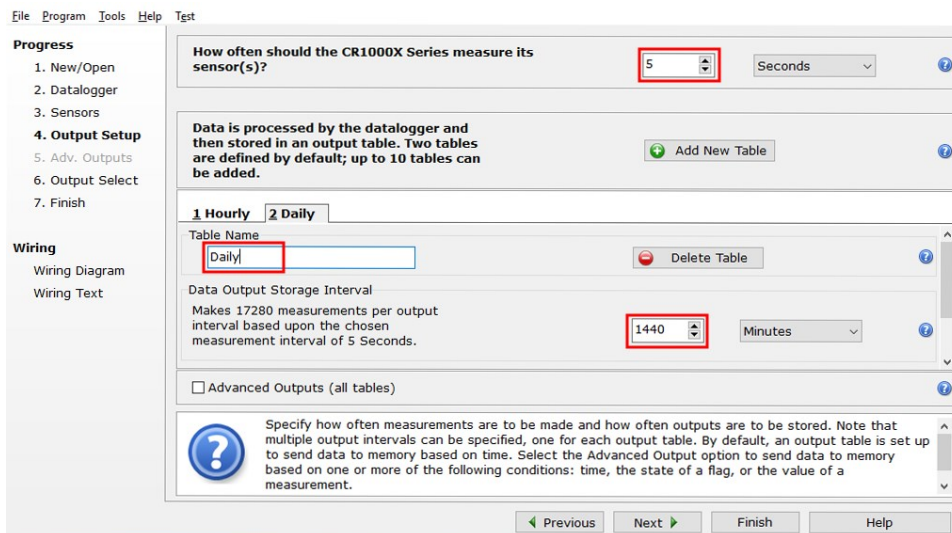

- Select the output options.

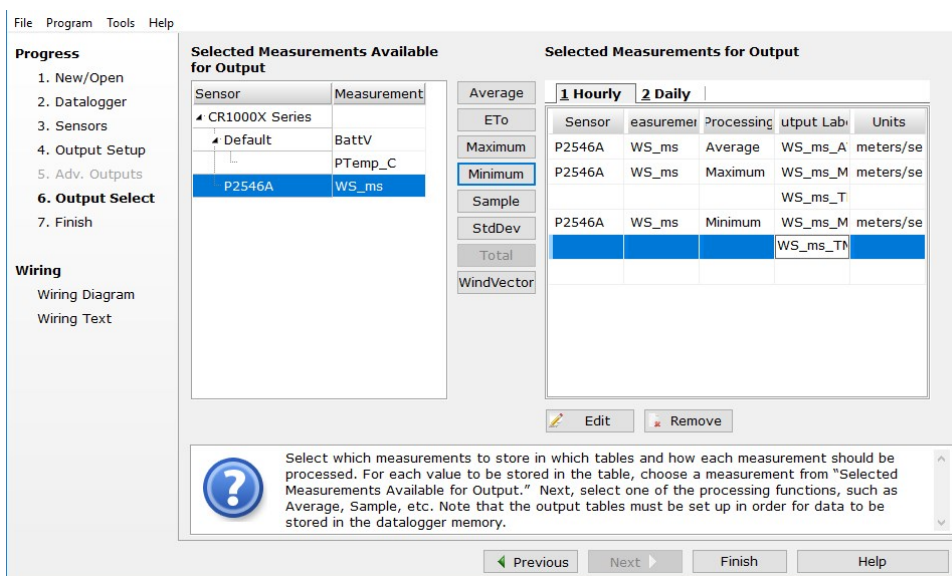

- Click **Finish** and save the program. Send the program to the data logger if the data logger is connected to the computer.
- If the sensor is connected to the data logger, check the output of the sensor in the data display in *LoggerNet*, *RTDAQ*, or *PC400* to make sure it is making reasonable measurements.

# 5. Overview

---

The P2546A, P2546C, and P2546D are sturdy anemometers that sense wind speed with a three-cup rotor assembly and permanent magnets mounted to the shaft (see [FIGURE 5-1](#) (p. 5)). With the P2546A, the magnets cause a switch to close and open two times per revolution. The switch has no bounce, and is equipped with a special mechanism that reduces the variation in operating time over the frequency range. This feature facilitates obtaining instantaneous wind speed by measuring the time interval of each revolution.

With the P2546C, the magnets induce a sine wave voltage inside a coil that produces an output signal with frequency proportional to wind speed.

With the P2546D, the magnets activate an electronic switching current that generates an output signal with a frequency that is proportional to the wind speed.



*FIGURE 5-1. P2546-series anemometer*

The P2546A, P2546C, and P2546D anemometers are manufactured by Windsensor and cabled by Campbell Scientific.

## Features:

- Calibration — Each anemometer is shipped with a MEASNET certificate containing information about where the anemometer was calibrated, the calibration procedure used, the calibration equation obtained, and the serial number of the anemometer.
- Quality — Made entirely of durable materials such as anodized aluminum and stainless steel.
- Compatible with Campbell Scientific CRBasic data loggers: CR6 series, CR3000, CR1000X series, CR800 series, CR300 series, and CR1000

# 6. Specifications

---

### NOTE:

Specifications are based on 80 wind tunnel calibrations performed according to the Measnet Cup Anemometer Calibration Procedure. The specified offset and gain are the mean values of these calibrations. Variation is calculated from the straight line of the mean values. All units were tested for 225 hours at 9 m/s, to reduce the initial bearing friction to a level close to the steady state value. Afterwards, bearing friction was tested at  $-15\text{ }^{\circ}\text{C}$  and at room temperature. The allowed limits for this test assure that the temperature influence on the calibration is within the specified limit.

<b>Starting threshold:</b>	< 0.4 m/s
<b>Resolution:</b>	0.001 m/s @ 10-minute average mode
<b>Range:</b>	0 to 75 m/s
<b>Distance constant:</b>	$\lambda_0 = 1.81 \pm 0.04\text{ m}$



# 6.1 Calibration

**Standard:**  $U = A_0 + B_0 \times f$

Where:

$U$  = Wind speed in m/s

$f$  = Output frequency in Hz

$A_0 = 0.27$  m/s

$B_0 = 0.620$  m

**Calibration:** Each anemometer individually calibrated compliant with IEC 61400-12-1

**Calibration mean value:**  $U = 0.620 \times f + 0.217$  [m/s]

**Variation of calibrations:**  $\sigma = 0.015$  m/s @ 10 m/s

# 6.2 Accuracy

**NOTE:**

Accuracy is a qualitative concept which is quantified in terms of uncertainty. The anemometer-specific uncertainty is the combined uncertainty of the calibration uncertainty,  $u_{V1}$ , and the operational uncertainty,  $u_{V2}$ , as determined by the class number,  $k$  according to IEC 61400-12-1.

**Calibration uncertainty**

( $u_{V1}, k=1$ ) @ 4 to 16 m/s: 0.28 % (P2546A, P2546C), 0.012 to 0.038 m/s (P2546D)

Class number, $k$	Operational standard uncertainty, $u_{V2}$ @ 10 m/s
1.32A	0.076 m/s
3.71B	0.214 m/s
1.54C	0.089 m/s
3.76D	0.217 m/s
0.03 to 3.76S	0.002 to 0.217 m/s

## 6.3 Output signal

### 6.3.1 P2546A switching characteristics

Signal type:	Potential free contact closure
Duty cycle:	40% to 60%
Maximum switching voltage:	30 V
Maximum recommended switching current:	10 mA
Series resistance:	330 $\Omega$ , 1 W

### 6.3.2 P2546C output signal

Signal type:	Low-level AC sine wave
Output voltage:	25 mV peak, minimum (@ 0.4 m/s); 14 V peak, typical (@ 75 m/s)
Output resistance:	650 $\pm$ 50 $\Omega$

### 6.3.3 P2546D output signal

Signal type:	NPN open collector, frequency proportional to wind speed
Duty cycle:	45% to 55 %
Maximum switching voltage:	30 V
Maximum switching current:	10 mA
Output resistance:	60 $\Omega$
Pull-up resistor:	100 k $\Omega$ max @ switching voltage = 5 V 10 k $\Omega$ max @ switching voltage > 5 V

## 6.4 Environmental

Operating temperature: –35 to 60 °C (P2546A, P2546C)  
–40 to 60 °C (P2546D)

Operating humidity range: 0 to 100% RH

EMC compliance: EN61326-1 Class A

## 6.5 Physical

Exterior materials: Anodized aluminum, stainless steel and GRP

Overall height: 28.2 cm (11.1 in)

Swept diameter of rotor: 18.8 cm (7.4 in)

Weight: 0.40 kg (14.1 oz)

# 7. Installation

---

If you are programming your data logger with *Short Cut*, skip [Wiring](#) (p. 11) and [Programming](#) (p. 13). *Short Cut* does this work for you. See [QuickStart](#) (p. 2) for a tutorial.

## 7.1 Siting

Locate the wind sensor away from obstructions, such as trees or buildings. The horizontal distance should be at least ten times the height of the obstruction between the wind sensor and obstruction. If mounting the sensor on a roof, the height of the sensor above the roof should be at least 1.5 times the height of the building. See [References](#) (p. 16) for a list of references that discuss siting wind speed and direction sensors. For power performance applications, refer to IEC 61400-12-1, which specifies the mounting and location of anemometers.

## 7.2 Mount the sensor

1. Mount a crossarm to a tripod or tower.
2. If a pyranometer is also being mounted on the crossarm, orient the crossarm north-south, with the 3/4 x 1 inch Nu-Rail Crossover Fitting or CM220 Right-Angle Mounting Kit on the end farthest from the equator. Otherwise, the crossarm may be oriented north-south, east-west, or any other angle desired.
3. Route the cable in the 76 cm (30 in) mounting pipe.
4. Place the 76 cm (30 in) mounting pipe in the bottom of the anemometer and secure the pipe to the anemometer using the set screws and Allen wrench (shipped with the anemometer). See [FIGURE 7-1](#) (p. 10).



*FIGURE 7-1. P2546A wind sensor installed on mounting pipe*

5. Place the mounting pipe in the Nu-Rail fitting ([FIGURE 7-2](#) (p. 11)) or in the CM220 U-bolt and tighten the U-bolt nuts ([FIGURE 7-3](#) (p. 11)).
6. Use a bubble level to ensure that the anemometer is level.

7. Route the sensor cable along the underside of the crossarm to the tripod or tower, and to the instrument enclosure.
8. Secure the cable to the mounting pipe, crossarm, and tripod or tower using cable ties.

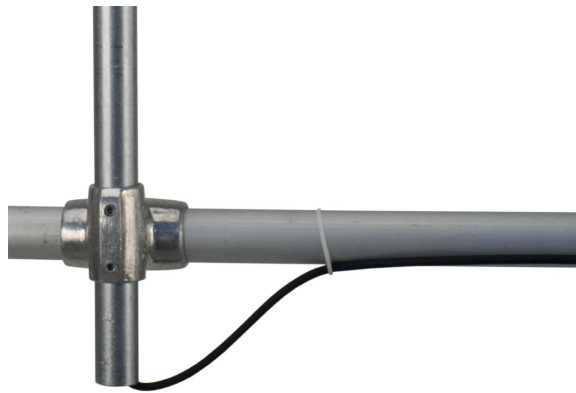

*FIGURE 7-2. Mounting pipe secured to a crossarm using the Nu-Rail Crossover Fitting*

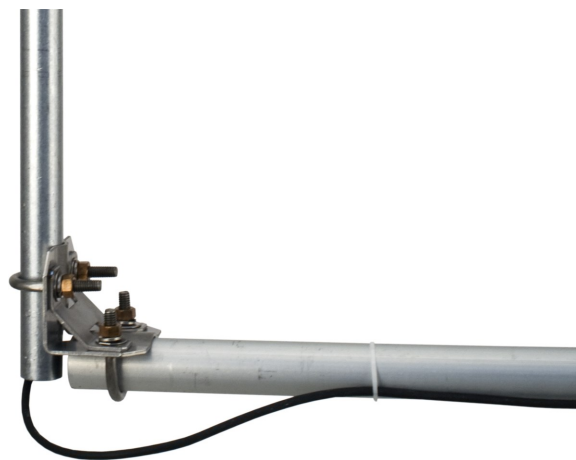

*FIGURE 7-3. Mounting pipe secured to a crossarm using the CM220 Right-Angle Mounting Kit*

## 7.3 Wiring

P2546A connections to Campbell Scientific data loggers are given in [Table 7-1](#) (p. 12). P2546C connections to Campbell Scientific data loggers are given in [Table 7-2](#) (p. 12). P2546D connections to Campbell Scientific data loggers are given in [Table 7-3](#) (p. 12).

**Table 7-1: P2546A wire color, wire function, and data logger connection**

Wire color	Wire function	Data logger connections using a pulse terminal	Data logger connections using a control terminal
White or red	Signal	U configured for pulse input <sup>1</sup> , P (pulse input), or P_SW (pulse, switch closure input)	C (control terminal)
Black or brown	Signal reference	⏏	5V
Clear	Shield	⏏ (analog ground)	⏏ (analog ground)

<sup>1</sup>U terminals are automatically configured by the measurement instruction.

**Table 7-2: P2546C wire color, wire function, and data logger connection**

Wire color	Wire function	Data logger connection terminal
White	Signal	U configured for pulse input <sup>1</sup> , P (pulse input), or P_LL (pulse, low-level ac input)
Black	Signal reference	⏏
Clear	Shield	⏏ (analog ground)

<sup>1</sup>U terminals are automatically configured by the measurement instruction.

**Table 7-3: P2546D wire color, wire function, and data logger connection**

Wire color	Wire function	Pulse input data logger connection terminal	Control terminal data logger connection terminal
White	Signal	U configured for pulse input <sup>1</sup> , P (pulse input), P_SW (pulse, switch closure input), P_LL (pulse, low-level ac input)	C (control terminal) <sup>2</sup>
Black	Signal reference	⏏	5V
Clear	Shield	⏏ (analog ground)	⏏ (analog ground)

<sup>1</sup>U terminals are automatically configured by the measurement instruction.

<sup>2</sup>When using a control terminal, the CR3000 and CR1000 data loggers need an external 10k-ohm pull-up resistor between the control terminal and 5V terminal (FIGURE 7-4 (p. 13)).

The P2546D requires either an internal or external pull-up resistor between the power supply and control terminal (FIGURE 7-4 (p. 13)). Most Campbell Scientific data loggers include an internal pull-up resistor. The CR3000 and CR1000 require an external 10k-ohm resistor when using a control terminal instead of a pulse terminal.

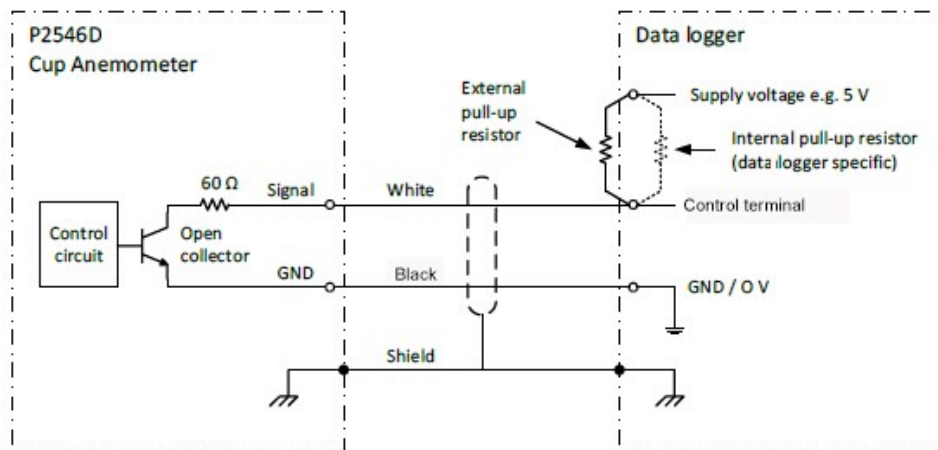

FIGURE 7-4. P2546D circuit diagram

## 7.4 Programming

**Short Cut** is the best source for up-to-date data logger programming code for the P2546A; the P2546C and P2546D are not in **Short Cut**.

If your data acquisition requirements are simple and you are connecting the sensor to a pulse terminal, you can probably create and maintain a data logger program exclusively with **Short Cut**. If your data acquisition needs are more complex, the files that **Short Cut** creates are a great source for programming code to start a new program or add to an existing custom program.

### NOTE:

**Short Cut** cannot edit programs after they are imported and edited in **CRBasic Editor**.

A **Short Cut** tutorial is available in [QuickStart](#) (p. 2). If you wish to import **Short Cut** code into **CRBasic Editor** to create or add to a customized program, follow the procedure in [Importing Short Cut code into CRBasic Editor](#) (p. 17). Programming basics for CRBasic data loggers are provided in this section. Complete program examples for select CRBasic data loggers can be found in [Example programs](#) (p. 18). Programming basics and programming examples for Edlog data loggers are provided at [www.campbellsci.com/old-manuals](http://www.campbellsci.com/old-manuals) [↗](#).

Wind speed is measured by using the **PulseCount()** instruction. Syntax of the the **PulseCount()** instruction is:

**PulseCount**(Dest, Reps, PChan, PConfig, POption, Mult, Offset)

Table 7-4 (p. 14) provides the appropriate **PConfig** parameter for each of the models. Configure the anemometers to output the results in Hertz (Hz).

Table 7-4: PConfig settings		
P2546A	P2546C	P2546D
Switch closure or switch closure with pull up	Low level AC	High frequency or high frequency with pull up

For the anemometers, the expression for wind speed (U) is:

$$U = MX + B$$

where

M = multiplier

X = number of pulses per second (Hertz)

B = offset

Table 7-5 (p. 14) lists the multiplier and offset to obtain meters per second (m/s) when the **PulseCount()** instruction is configured to output the result in Hz.

Table 7-5: Wind speed multiplier and offset (measurements in m/s)		
Calibration	Multiplier	Offset
Standard	0.620	0.27
MEASNET	Values listed on the MEASNET calibration sheet included with each sensor	



# 8. Troubleshooting and maintenance

---

## 8.1 Troubleshooting

### Symptom: No wind speed

1. Check that the sensor is wired to the pulse terminal specified by the `PulseCount()` instruction.
2. Verify that the `Configuration Code`, and `Multiplier` and `Offset` parameters for the `PulseCount()` instruction are correct for the data logger type.

## 8.2 Maintenance

Every month do a visual/audio inspection of the anemometer at low wind speeds. Verify that the anemometer bearings rotate freely. Inspect the sensor for physical damage. Replace the anemometer bearings when they become noisy, or the wind speed threshold increases above an acceptable level.

### CAUTION:

Disassembling an anemometer to change the bearings will invalidate the MEASNET calibration.

MEASNET calibrations are normally valid for 12 months in the field (assuming the anemometer is installed within 6 months of the calibration test). In high-accuracy applications, Campbell Scientific recommends that the anemometer be returned to us for maintenance/overhaul between deployments.

### NOTE:

Campbell Scientific cannot perform in-house MEASNET calibrations, but we can arrange for a new MEASNET calibration after maintenance/overhaul when required.

Before the anemometer is sent to Campbell Scientific, the customer must get an RMA (returned material authorization) and fill out the Declaration of Hazardous Material and Decontamination form. Refer to the [Assistance](#) page for more information.

# 9. References

---

IEC 61400 Part 12-1, "Wind turbine generator systems Part 12: Wind Turbine Power Performance Testing".

The following references give detailed information on siting wind speed and wind direction sensors.

EPA, 1989: *Quality Assurance Handbook for Air Pollution Measurements System*, Office of Research and Development, Research Triangle Park, NC, 27711.

EPA, 1987: *On-Site Meteorological Program Guidance for Regulatory Modeling Applications*, EPA-450/4-87-013, Office of Air Quality Planning and Standards, Research Triangle Park, NC 27711.

The State Climatologist, 1985: *Publication of the American Association of State Climatologists: Height and Exposure Standards*, for Sensors on Automated Weather Stations, vol. 9, No. 4.

WMO, 1983: *Guide to Meteorological Instruments and Methods of Observation*, World Meteorological Organization, No. 8, 5th edition, Geneva, Switzerland.

# Appendix A. Importing *Short Cut* code into *CRBasic Editor*

---

*Short Cut* creates a .DEF file that contains wiring information and a program file that can be imported into the *CRBasic Editor*. By default, these files reside in the C:\campbellsci\SCWin folder.

Import *Short Cut* program file and wiring information into *CRBasic Editor*:

1. Create the *Short Cut* program. After saving the *Short Cut* program, click the **Advanced** tab then the **CRBasic Editor** button. A program file with a generic name will open in CRBasic. Provide a meaningful name and save the CRBasic program. This program can now be edited for additional refinement.

**NOTE:**

Once the file is edited with *CRBasic Editor*, *Short Cut* can no longer be used to edit the program it created.

2. To add the *Short Cut* wiring information into the new CRBasic program, open the .DEF file located in the C:\campbellsci\SCWin folder, and copy the wiring information, which is at the beginning of the .DEF file.
3. Go into the CRBasic program and paste the wiring information into it.
4. In the CRBasic program, highlight the wiring information, right-click, and select **Comment Block**. This adds an apostrophe (') to the beginning of each of the highlighted lines, which instructs the data logger compiler to ignore those lines when compiling. The **Comment Block** feature is demonstrated at about 5:10 in the [CRBasic | Features](#) video .

# Appendix B. Example programs

## B.1 P2546A programs

CRBasic Example 1 (p. 18) is a CR6 program that uses universal terminal 1 configured as a pulse terminal to measure the P2546A every 5 seconds. The program stores the mean, maximum, minimum, and standard deviation of the measured wind speed over a 60-minute interval.

### CRBasic Example 1: CR6 program measuring the P2546A

```
'CR6 Series

'Declare Variables and Units
Public BattV
Public PTemp_C
Public WS_ms

Units BattV=Volts
Units PTemp_C=Deg C
Units WS_ms=meters/second

'Define Data Tables
DataTable(Hourly,True,-1)
  DataInterval(0,60,Min,10)
  Sample(1,PTemp_C,FP2)
  Average(1,WS_ms,FP2,False)
  Maximum(1,WS_ms,FP2,False,False)
  Minimum(1,WS_ms,FP2,False,False)
  Minimum(1,BattV,FP2,False,False)
  StdDev(1,WS_ms,FP2,False)
EndTable

DataTable(Daily,True,-1)
  DataInterval(0,1440,Min,10)
  Minimum(1,BattV,FP2,False,False)
EndTable

'Main Program
BeginProg
  'Main Scan
  Scan(5,Sec,1,0)
  'Default Data Logger Battery Voltage measurement 'BattV'
  Battery(BattV)
  'Default Wiring Panel Temperature measurement 'PTemp_C'
```

## CRBasic Example 1: CR6 program measuring the P2546A

```
PanelTemp(PTemp_C, 60)
'P2546A Wind Speed Sensor measurement 'WS_ms''
PulseCount(WS_ms, 1, U1, 1, 1, 0.62, 0.27)
If WS_ms<=0.27 Then WS_ms=0
'Call Data Tables and Store Data'
CallTable Hourly
CallTable Daily
NextScan
EndProg
```

CRBasic Example 2 (p. 20) is a CR1000X program that uses pulse terminal 1 (P1) to measure the P2546A once a second. The program stores the mean, maximum, minimum, and standard deviation of the measured wind speed over a 10 minute interval.

### CRBasic Example 2: CR1000X program measuring the P2546A

```
'Pulse Port Example

'CR1000X Series DataLogger
'Program to measure P2546A

Const P2546A_mult = .62
Const p2546a_offset = .27

Public PTemp, batt_volt
Public P2546A

'Define Data Tables
DataTable (TenMin,True,-1)
  DataInterval (0,10,Min,10)
  Minimum (1,batt_volt,FP2,0,False)
  Sample (1,PTemp,FP2)
  Average (1,P2546A,FP2,False)
  Maximum (1,P2546A,FP2,False,False)
  Minimum (1,P2546A,FP2,False,False)
  StdDev (1,P2546A,FP2,False)
EndTable

'Main Program

BeginProg
  Scan (1,Sec,0,0)
  PanelTemp (PTemp,250)
  Battery (batt_volt)

  'Measure P2546A and correct measurement if wind speed is zero
  PulseCount (P2546A,1,P1,1,1,P2546A_mult,p2546a_offset)
  If P2546A <= p2546a_offset Then P2546A = 0

  'Call data tables
  CallTable TenMin

  NextScan
EndProg
```

## B.2 P2546C programs

CRBasic Example 3 (p. 21) is a CR6 program that uses universal terminal 2 to measure the P2546C every 5 seconds. The program stores the mean, maximum, minimum, and standard deviation of the measured wind speed over a 60 minute interval.

### CRBasic Example 3: CR6 program measuring the P2546C

```
'CR6 Series
'Declare Variables and Units
Public BattV
Public PTemp_C
Public WS_ms
Units BattV=Volts
Units PTemp_C=Deg C
Units WS_ms=meters/second
'Define Data Tables
DataTable(Hourly,True,-1)
  DataInterval(0,60,Min,10)
  Sample(1,PTemp_C,FP2)
  Average(1,WS_ms,FP2,False)
  Maximum(1,WS_ms,FP2,False,False)
  Minimum(1,WS_ms,FP2,False,False)
  Minimum(1,BattV,FP2,False,False)
  StdDev(1,WS_ms,FP2,False)
EndTable
DataTable(Daily,True,-1)
  DataInterval(0,1440,Min,10)
  Minimum(1,BattV,FP2,False,False)
EndTable

'Main Program
BeginProg
  'Main Scan
  Scan(5,Sec,1,0)
  'Default Data Logger Battery Voltage measurement 'BattV'
  Battery(BattV)
  'Default Wiring Panel Temperature measurement 'PTemp_C'
  PanelTemp(PTemp_C,60)
  'P2546C Wind Speed Sensor measurement 'WS_ms'
  PulseCount(WS_ms,1,U2,5,1,0.62,0.27)
  If WS_ms<=0.27 Then WS_ms=0
  'Call Data Tables and Store Data
  CallTable Hourly
  CallTable Daily
NextScan
EndProg
```

CRBasic Example 4 (p. 22) is a CR1000X program that uses pulse terminal 1 (P1) to measure the P2546C once a second. The program stores the mean, maximum, minimum, and standard deviation of the measured wind speed over a 10 minute interval.

#### CRBasic Example 4: CR1000X program measuring the P2546C

```
'CR1000X Series Datalogger
'Program to measure P2546C
Const P2546C_mult = .62
Const p2546c_offset = .27
Public PTemp, batt_volt
Public P2546C
'Define Data Tables
DataTable (TenMin,True,-1)
  DataInterval (0,10,Min,10)
  Minimum (1,batt_volt,FP2,0,False)
  Sample (1,PTemp,FP2)
  Average (1,P2546C,FP2,False)
  Maximum (1,P2546C,FP2,False,False)
  Minimum (1,P2546C,FP2,False,False)
  StdDev (1,P2546C,FP2,False)
EndTable

'Main Program
BeginProg
  Scan (1,Sec,0,0)
  PanelTemp (PTemp,250)
  Battery (batt_volt)
  'Measure P2546C and correct measurement if wind speed is zero
  PulseCount (P2546C,1,P1 ,5,1,P2546C_mult,p2546c_offset)
  If P2546C <= p2546c_offset Then P2546C = 0
  'Call data tables
  CallTable TenMin
NextScan
EndProg
```



## B.3 P2546D program

CRBasic Example 5 (p. 23) is a CR1000X program that uses pulse terminal 1 (P1) to measure the P2546D once a second. The program stores the mean, maximum, minimum, and standard deviation of the measured wind speed over a 10-minute interval.

### CRBasic Example 5: CR1000X program measuring the P2546D

```
'Pulse Port Example
'CR1000X Series DataLogger
'Program to measure P2546D
Const P2546D_mult = .62
Const p2546d_offset = .27
Public PTemp, batt_volt
Public P2546D
'Define Data Tables
DataTable (TenMin,True,-1)
  DataInterval (0,10,Min,10)
  Minimum (1,batt_volt,FP2,0,False)
  Sample (1,PTemp,FP2)
  Average (1,P2546D,FP2,False)
  Maximum (1,P2546D,FP2,False,False)
  Minimum (1,P2546D,FP2,False,False)
  StdDev (1,P2546D,FP2,False)
EndTable
'Main Program
BeginProg
  Scan (1,Sec,0,0)
  PanelTemp (PTemp,250)
  Battery (batt_volt)
  'Measure P2546D and correct measurement if wind speed is zero
  PulseCount (P2546D,1,P1,3,1,P2546D_mult,p2546d_offset)
  If P2546D <= p2546d_offset Then P2546D = 0
  'Call data tables
  CallTable TenMin
NextScan
EndProg
```

# Limited warranty

---

Products manufactured by Campbell Scientific are warranted by Campbell Scientific to be free from defects in materials and workmanship under normal use and service for twelve months from the date of shipment unless otherwise specified on the corresponding product webpage. See Product Details on the Ordering Information pages at [www.campbellsci.com](http://www.campbellsci.com)<sup>↗</sup>. Other manufacturer's products, that are resold by Campbell Scientific, are warranted only to the limits extended by the original manufacturer.

Refer to [www.campbellsci.com/terms#warranty](http://www.campbellsci.com/terms#warranty)<sup>↗</sup> for more information.

**CAMPBELL SCIENTIFIC EXPRESSLY DISCLAIMS AND EXCLUDES ANY IMPLIED WARRANTIES OF MERCHANTABILITY OR FITNESS FOR A PARTICULAR PURPOSE.** Campbell Scientific hereby disclaims, to the fullest extent allowed by applicable law, any and all warranties and conditions with respect to the Products, whether express, implied or statutory, other than those expressly provided herein.

# Assistance

---

Products may not be returned without prior authorization.

Products shipped to Campbell Scientific require a Returned Materials Authorization (RMA) or Repair Reference number and must be clean and uncontaminated by harmful substances, such as hazardous materials, chemicals, insects, and pests. Please complete the required forms prior to shipping equipment.

Campbell Scientific regional offices handle repairs for customers within their territories. Please see the back page for the Global Sales and Support Network or visit [www.campbellsci.com/contact](http://www.campbellsci.com/contact)  to determine which Campbell Scientific office serves your country.

To obtain a Returned Materials Authorization or Repair Reference number, contact your CAMPBELL SCIENTIFIC regional office. Please write the issued number clearly on the outside of the shipping container and ship as directed.

For all returns, the customer must provide a "Statement of Product Cleanliness and Decontamination" or "Declaration of Hazardous Material and Decontamination" form and comply with the requirements specified in it. The form is available from your CAMPBELL SCIENTIFIC regional office. Campbell Scientific is unable to process any returns until we receive this statement. If the statement is not received within three days of product receipt or is incomplete, the product will be returned to the customer at the customer's expense. Campbell Scientific reserves the right to refuse service on products that were exposed to contaminants that may cause health or safety concerns for our employees.

# Safety

---

**DANGER — MANY HAZARDS ARE ASSOCIATED WITH INSTALLING, USING, MAINTAINING, AND WORKING ON OR AROUND TRIPODS, TOWERS, AND ANY ATTACHMENTS TO TRIPODS AND TOWERS SUCH AS SENSORS, CROSSARMS, ENCLOSURES, ANTENNAS, ETC.** FAILURE TO PROPERLY AND COMPLETELY ASSEMBLE, INSTALL, OPERATE, USE, AND MAINTAIN TRIPODS, TOWERS, AND ATTACHMENTS, AND FAILURE TO HEED WARNINGS, INCREASES THE RISK OF DEATH, ACCIDENT, SERIOUS INJURY, PROPERTY DAMAGE, AND PRODUCT FAILURE. TAKE ALL REASONABLE PRECAUTIONS TO AVOID THESE HAZARDS. CHECK WITH YOUR ORGANIZATION'S SAFETY COORDINATOR (OR POLICY) FOR PROCEDURES AND REQUIRED PROTECTIVE EQUIPMENT PRIOR TO PERFORMING ANY WORK.

Use tripods, towers, and attachments to tripods and towers only for purposes for which they are designed. Do not exceed design limits. Be familiar and comply with all instructions provided in product manuals. Manuals are available at [www.campbellsci.com](http://www.campbellsci.com). You are responsible for conformance with governing codes and regulations, including safety regulations, and the integrity and location of structures or land to which towers, tripods, and any attachments are attached. Installation sites should be evaluated and approved by a qualified engineer. If questions or concerns arise regarding installation, use, or maintenance of tripods, towers, attachments, or electrical connections, consult with a licensed and qualified engineer or electrician.

## General

- Protect from over-voltage.
- Protect electrical equipment from water.
- Protect from electrostatic discharge (ESD).
- Protect from lightning.
- Prior to performing site or installation work, obtain required approvals and permits. Comply with all governing structure-height regulations.
- Use only qualified personnel for installation, use, and maintenance of tripods and towers, and any attachments to tripods and towers. The use of licensed and qualified contractors is highly recommended.
- Read all applicable instructions carefully and understand procedures thoroughly before beginning work.
- Wear a **hardhat** and **eye protection**, and take **other appropriate safety precautions** while working on or around tripods and towers.
- **Do not climb** tripods or towers at any time, and prohibit climbing by other persons. Take reasonable precautions to secure tripod and tower sites from trespassers.
- Use only manufacturer recommended parts, materials, and tools.

## Utility and Electrical

- **You can be killed** or sustain serious bodily injury if the tripod, tower, or attachments you are installing, constructing, using, or maintaining, or a tool, stake, or anchor, come in **contact with overhead or underground utility lines**.
- Maintain a distance of at least one-and-one-half times structure height, 6 meters (20 feet), or the distance required by applicable law, **whichever is greater**, between overhead utility lines and the structure (tripod, tower, attachments, or tools).
- Prior to performing site or installation work, inform all utility companies and have all underground utilities marked.
- Comply with all electrical codes. Electrical equipment and related grounding devices should be installed by a licensed and qualified electrician.
- Only use power sources approved for use in the country of installation to power Campbell Scientific devices.

## Elevated Work and Weather

- Exercise extreme caution when performing elevated work.
- Use appropriate equipment and safety practices.
- During installation and maintenance, keep tower and tripod sites clear of un-trained or non-essential personnel. Take precautions to prevent elevated tools and objects from dropping.
- Do not perform any work in inclement weather, including wind, rain, snow, lightning, etc.

## Maintenance

- Periodically (at least yearly) check for wear and damage, including corrosion, stress cracks, frayed cables, loose cable clamps, cable tightness, etc. and take necessary corrective actions.
- Periodically (at least yearly) check electrical ground connections.

## Internal Battery

- Be aware of fire, explosion, and severe-burn hazards.
- Misuse or improper installation of the internal lithium battery can cause severe injury.
- Do not recharge, disassemble, heat above 100 °C (212 °F), solder directly to the cell, incinerate, or expose contents to water. Dispose of spent batteries properly.

WHILE EVERY ATTEMPT IS MADE TO EMBODY THE HIGHEST DEGREE OF SAFETY IN ALL CAMPBELL SCIENTIFIC PRODUCTS, THE CUSTOMER ASSUMES ALL RISK FROM ANY INJURY RESULTING FROM IMPROPER INSTALLATION, USE, OR MAINTENANCE OF TRIPODS, TOWERS, OR ATTACHMENTS TO TRIPODS AND TOWERS SUCH AS SENSORS, CROSSARMS, ENCLOSURES, ANTENNAS, ETC.



## Global Sales & Support Network

A worldwide network to help meet your needs



### Campbell Scientific Regional Offices

#### Australia

**Location:** Garbutt, QLD Australia  
**Phone:** 61.7.4401.7700  
**Email:** [info@campbellsci.com.au](mailto:info@campbellsci.com.au)  
**Website:** [www.campbellsci.com.au](http://www.campbellsci.com.au)

#### Brazil

**Location:** São Paulo, SP Brazil  
**Phone:** 11.3732.3399  
**Email:** [vendas@campbellsci.com.br](mailto:vendas@campbellsci.com.br)  
**Website:** [www.campbellsci.com.br](http://www.campbellsci.com.br)

#### Canada

**Location:** Edmonton, AB Canada  
**Phone:** 780.454.2505  
**Email:** [dataloggers@campbellsci.ca](mailto:dataloggers@campbellsci.ca)  
**Website:** [www.campbellsci.ca](http://www.campbellsci.ca)

#### China

**Location:** Beijing, P. R. China  
**Phone:** 86.10.6561.0080  
**Email:** [info@campbellsci.com.cn](mailto:info@campbellsci.com.cn)  
**Website:** [www.campbellsci.com.cn](http://www.campbellsci.com.cn)

#### Costa Rica

**Location:** San Pedro, Costa Rica  
**Phone:** 506.2280.1564  
**Email:** [info@campbellsci.com](mailto:info@campbellsci.com)  
**Website:** [www.campbellsci.com](http://www.campbellsci.com)

#### France

**Location:** Vincennes, France  
**Phone:** 0033.0.1.56.45.15.20  
**Email:** [info@campbellsci.fr](mailto:info@campbellsci.fr)  
**Website:** [www.campbellsci.fr](http://www.campbellsci.fr)

#### Germany

**Location:** Bremen, Germany  
**Phone:** 49.0.421.460974.0  
**Email:** [info@campbellsci.de](mailto:info@campbellsci.de)  
**Website:** [www.campbellsci.de](http://www.campbellsci.de)

#### India

**Location:** New Delhi, DL India  
**Phone:** 91.11.46500481.482  
**Email:** [info@campbellsci.in](mailto:info@campbellsci.in)  
**Website:** [www.campbellsci.in](http://www.campbellsci.in)

#### South Africa

**Location:** Stellenbosch, South Africa  
**Phone:** 27.21.8809960  
**Email:** [sales@campbellsci.co.za](mailto:sales@campbellsci.co.za)  
**Website:** [www.campbellsci.co.za](http://www.campbellsci.co.za)

#### Spain

**Location:** Barcelona, Spain  
**Phone:** 34.93.2323938  
**Email:** [info@campbellsci.es](mailto:info@campbellsci.es)  
**Website:** [www.campbellsci.es](http://www.campbellsci.es)

#### Thailand

**Location:** Bangkok, Thailand  
**Phone:** 66.2.719.3399  
**Email:** [info@campbellsci.asia](mailto:info@campbellsci.asia)  
**Website:** [www.campbellsci.asia](http://www.campbellsci.asia)

#### UK

**Location:** Shepshed, Loughborough, UK  
**Phone:** 44.0.1509.601141  
**Email:** [sales@campbellsci.co.uk](mailto:sales@campbellsci.co.uk)  
**Website:** [www.campbellsci.co.uk](http://www.campbellsci.co.uk)

#### USA

**Location:** Logan, UT USA  
**Phone:** 435.227.9120  
**Email:** [info@campbellsci.com](mailto:info@campbellsci.com)  
**Website:** [www.campbellsci.com](http://www.campbellsci.com)