

INSTRUCTION MANUAL



Open-Path Eddy-Covariance
System Operator's Manual
IRGASON, KH20, and FW05

Revision: 4/13



Copyright © 2004-2013
Campbell Scientific, Inc.

Warranty

“PRODUCTS MANUFACTURED BY CAMPBELL SCIENTIFIC, INC. are warranted by Campbell Scientific, Inc. (“Campbell”) to be free from defects in materials and workmanship under normal use and service for twelve (12) months from date of shipment unless otherwise specified in the corresponding Campbell pricelist or product manual. Products not manufactured, but that are re-sold by Campbell, are warranted only to the limits extended by the original manufacturer. Batteries, fine-wire thermocouples, desiccant, and other consumables have no warranty. Campbell’s obligation under this warranty is limited to repairing or replacing (at Campbell’s option) defective products, which shall be the sole and exclusive remedy under this warranty. The customer shall assume all costs of removing, reinstalling, and shipping defective products to Campbell. Campbell will return such products by surface carrier prepaid within the continental United States of America. To all other locations, Campbell will return such products best way CIP (Port of Entry) INCOTERM® 2010, prepaid. This warranty shall not apply to any products which have been subjected to modification, misuse, neglect, improper service, accidents of nature, or shipping damage. This warranty is in lieu of all other warranties, expressed or implied. The warranty for installation services performed by Campbell such as programming to customer specifications, electrical connections to products manufactured by Campbell, and product specific training, is part of Campbell’s product warranty. **CAMPBELL EXPRESSLY DISCLAIMS AND EXCLUDES ANY IMPLIED WARRANTIES OF MERCHANTABILITY OR FITNESS FOR A PARTICULAR PURPOSE.** Campbell is not liable for any special, indirect, incidental, and/or consequential damages.”

Assistance

Products may not be returned without prior authorization. The following contact information is for US and international customers residing in countries served by Campbell Scientific, Inc. directly. Affiliate companies handle repairs for customers within their territories. Please visit www.campbellsci.com to determine which Campbell Scientific company serves your country.

To obtain a Returned Materials Authorization (RMA), contact CAMPBELL SCIENTIFIC, INC., phone (435) 227-9000. After an applications engineer determines the nature of the problem, an RMA number will be issued. Please write this number clearly on the outside of the shipping container. Campbell Scientific's shipping address is:

CAMPBELL SCIENTIFIC, INC.

RMA# _____
815 West 1800 North
Logan, Utah 84321-1784

For all returns, the customer must fill out a "Statement of Product Cleanliness and Decontamination" form and comply with the requirements specified in it. The form is available from our web site at www.campbellsci.com/repair. A completed form must be either emailed to repair@campbellsci.com or faxed to (435) 227-9106. Campbell Scientific is unable to process any returns until we receive this form. If the form is not received within three days of product receipt or is incomplete, the product will be returned to the customer at the customer's expense. Campbell Scientific reserves the right to refuse service on products that were exposed to contaminants that may cause health or safety concerns for our employees.

Table of Contents

PDF viewers: These page numbers refer to the printed version of this document. Use the PDF reader bookmarks tab for links to specific sections.

1. System Description	1
1.1 OPEC (CSAT3 Only).....	1
1.2 Basic OPEC.....	1
1.3 Extended OPEC	2
1.4 Additional Fast Response Sensors	2
2. Installation and Mounting	2
2.1 Fetch and Sensor Height	4
2.2 Mounting.....	4
2.2.1 Measure Sonic Azimuth.....	4
2.3 Wiring	4
2.4 Power	4
3. System Datalogger Program.....	5
3.1 Program Configuration.....	6
3.1.1 Sonic Azimuth	6
3.1.2 Sensor Configuration	8
3.2 Loading a Program to the Datalogger	9
3.2.1 Direct Connection via LoggerNet.....	9
3.2.2 Remote via PC/CF Card.....	9
3.3 System Operation.....	10
3.3.1 Monitoring Data.....	10
3.3.2 Status Table.....	10
4. Data.....	11
4.1 Data Retrieval	12
4.1.1 Direct Connection Data Retrieval via LoggerNet	13
4.1.2 File Management with Baler.....	15
4.1.3 Remote Data Retrieval via a PC/CF Card.....	17
4.1.4 File Management with CardConvert	18
4.1.4.1 Collecting Data with One Card	21
4.1.4.2 Collecting Data with Two Cards	22
4.2 Data Processing.....	24
4.2.1 Online Processing	24
4.2.2 Off-line Processing with EdiRe	24
4.2.2.1 Creating Raw File Format and Processing Lists	25
4.2.2.2 Example EdiRe Raw File Format and Processing Lists	27
5. Basic Eddy-Covariance Theory.....	31

Appendices

A. CSAT3 Orientation	A-1
A.1 Determining True North and Sensor Orientation	A-1
A.2 Online Magnetic Declination Calculator	A-3
B. References.....	B-1
C. OPEC200 Open Path Eddy Covariance System Quickstart Guide.....	C-1

Figures

2-1. Open-Path Eddy-Covariance (IRGASON) System	3
3-1. IRGASON right hand coordinate system, horizontal wind vector angle is 0 degrees	7
3-2. Compass coordinate system, compass wind direction is 140 degrees	8
4-1. LoggerNet station setup for the “flux” table.....	13
4-2. LoggerNet station setup for the “ts_data” table.....	14
4-3. LoggerNet station data collection schedule	14
4-4. LoggerNet station status monitor	15
4-5. Baler station setup for the “flux” table	16
4-6. Baler station setup for the “ts_data” table	16
4-7. File format flow	18
4-8. Destination File Option screen	19
4-9. Fully configured CardConvert start up screen	20
4-10. List of files created by CardConvert.....	21
4-11. List of files created by CardConvert with duplicates	22
4-12. List of files where the duplicate files are renamed to *.bak	22
4-13. List of files collected the first time using two cards	23
4-14. List of files collected the second time using two cards	23
4-15. Interpreter settings to read a Campbell Scientific TOB1 data file.....	26
4-16. Folder that contains the raw TOB1 time series data files	26
4-17. Completed Interpreter screen.....	27
4-18. Estimated sample frequency and correct sample frequency	27
4-19. Default EdiRe processing list created by the Interpreter	28
4-20. Output file location as part of the processing list	29
4-21. Output file location as part of the processing list	29
4-22. Processing U_z and CO_2 with 1 Chn Statistics instruction	30
4-23. Computing CO_2 flux with 2 Chn Statistics and graphing U_z statistic with Plot Value instruction	30
5-1. Ideal vertical profiles of virtual potential temperature and specific humidity depicting all the layers of the atmospheric boundary layer	31
A-1. Magnetic declination for the conterminous United States (2004) ...	A-1
A-2. A declination angle East of True North (positive) is subtracted from 360 (0) degrees to find True North.....	A-2
A-3. A declination angle West of True North (negative) is subtracted from 0 (360) degrees to find True North.....	A-2
A-4. Online magnetic declination calculator with inputs and output for Longmont, CO.....	A-3

Tables

2-1. Nominal Sensor Power Requirements.....5
2-2. Nominal Datalogger Power Requirements with the Display Off
and No RS-232 Communications5
2-3. Nominal Datalogger Power Requirements with the Display and
Backlight On, and No RS-232 Communications.....5

OPEC Open-Path Eddy-Covariance System

This document will serve as a guide to properly install and operate a Campbell Scientific Open-Path Eddy-Covariance System (OPEC). The OPEC is composed of various products, e.g., dataloggers, fast response turbulence sensors, slow response meteorological sensors, and software. These products are manufactured by Campbell Scientific and other vendors. Manuals for each of these sensors shipped with the system. It is time well spent reviewing these documents.

Before deploying the equipment in the field, Campbell Scientific Inc. recommends that it be installed in the lab or outside near the office. Doing so will give the station operator an opportunity practice installing the equipment, confirming that all the required parts are available, and practice retrieving data from the system. It is much more convenient and less expensive to trouble shoot the station near the office.

The literature contains information that spans 50 years on Eddy-Covariance theory and measurements. Section 5 briefly touches Eddy-Covariance theory. For more details on Eddy-Covariance measurements and data analysis, see the literature.

1. System Description

The Campbell Scientific Open-Path Eddy-Covariance (OPEC) system measures sonic sensible heat flux, momentum flux, and the flux of other scalars between the atmosphere and earth's surface. The system consists of a datalogger, fast response three-dimensional sonic anemometer, and fast response scalar sensors. Horizontal wind speed and direction are computed by the datalogger from the three-dimensional measurements of wind made by the sonic anemometer.

1.1 OPEC (CSAT3 Only)

The minimum components required to make eddy-covariance measurements are a datalogger, a CSAT3 three-dimensional sonic anemometer, and a temperature and humidity probe. This system configuration measures sonic sensible heat flux, momentum flux, temperature, humidity, horizontal wind speed, and wind direction. This system configuration is used to compute eddy diffusivity required to compute fluxes of trace gases measured with a gradient system (Warland, et al., 2001).

1.2 Basic OPEC

A more typical eddy-covariance system consists of a datalogger, an IRGASON (integrated gas analyzer and sonic anemometer). With this configuration, the system can measure carbon dioxide flux, latent heat flux, sonic sensible heat flux, momentum flux, a sensible heat flux (using sonic temperature corrected for humidity), temperature, humidity, horizontal wind speed, and wind direction.

1.3 Extended OPEC

Energy balance sensors can be added to a basic OPEC system to also measure the net radiation, soil heat flux, soil temperature, and soil water content. The sensors required for these additional measurements are a NR-LITE, CNR2, NR01 or CNR4 net radiometer; two or four HFP01 or HFP01-SC soil heat flux plates, one or two TCAV averaging soil temperature probes, and one or two CS616 or CS650 soil moisture reflectometers. The number of soil sensors will vary with the site. A heterogeneous site will require more sensors to get adequate spatial representation of the site. The datalogger can accommodate the additional measurements with a multiplexer. Energy balance sensors no longer carried by Campbell Scientific are also supported by the extended OPEC datalogger program, including the Q7.1 and CNR1 net radiometers, and HFT3 soil heat flux plates.

1.4 Additional Fast Response Sensors

If the application requires a direct measurement of sensible heat flux, a FW05 can be added to the system. In the absence of a FW05 or if the FW05 breaks, the sensible heat flux can be found using the sonic temperature corrected for humidity.

A KH20 Krypton hygrometer, instead of the IRGASON gas analyzer, can be used to measure the latent heat flux. The KH20 can not be used to measure an absolute concentration of water vapor, because of scaling on the source tube windows caused by disassociation of atmospheric constituents by the ultra violet photons (Campbell and Tanner, 1985 and Buck, 1976). A slow response humidity sensor is used to measure the absolute humidity required to compute the air density. Air density is needed to scale the covariances into sensible heat flux and momentum flux. The rate of scaling on the KH20 windows is a function of the atmospheric humidity. In high humidity environments, scaling can occur within a few hours. That scaling attenuates the signal and can cause shifts in the calibration. However, the scaling over a typical flux averaging period is small. Thus, water vapor fluctuation measurements can still be made with the hygrometer. The effects of the scaling can be easily reversed by wiping the windows with a moist swab.

2. Installation and Mounting

When making eddy-covariance measurements near the surface (less than 3 meters), mount the datalogger enclosure between the legs of the CM106 tripod, on a separate tripod, or user-supplied drive stake. Also, mount any sensor electronics boxes as far from the fast response sensors as possible and always use the tripod guy kit. This will minimize potential flow distortions and tower sway caused by wind blowing against the fiberglass enclosure. See the tripod manuals for detailed installation instructions.

FIGURE 2-1 depicts a typical Open-Path Eddy-Covariance station. Point the Eddy-Covariance sensors into the prevailing wind to minimize the flow distortion from the tower, mounting hardware, and other sensors.

TIP Keep a log book for each station. Record the date and personnel name for all site visits, as well as all maintenance and work that is performed during the site visit. Document the condition of the sensors and site with a digital camera.



FIGURE 2-1. Open-Path Eddy-Covariance (IRGASON) System

2.1 Fetch and Sensor Height

The eddy-covariance sensors must be mounted at some height to ensure that the measurements are made within the local surface layer. The local surface layer grows at a rate of approximately 1 vertical meter per 100 horizontal meters. Thus, a height to fetch (horizontal distance travelled) ratio of 1:100 may be used as an *absolute bare minimum* rough rule of thumb for determining the measurement height.

The fetch should be homogenous and flat, and no abrupt changes in vegetation height should exist (Tanner, 1988). Consider two adjacent fields, the first planted with 1 m tall corn and the second with 0.5 m soybean. Eddy-Covariance sensors mounted at 2 m above the corn field should have a *minimum* of 200 m of fetch in all the directions that the data is of interest, particularly between the eddy-covariance sensors and the interface between the corn and soybean field.

2.2 Mounting

The IRGASON is mounted to a tripod or tower using a horizontal mounting arm (CM20x) and a leveling mounting kit (CM250). Section 3 of the IRGASON manual contains detailed information on mounting the sensors and EC100 electronics.

2.2.1 Measure Sonic Azimuth

To compute the correct compass wind direction, the station operator must enter the negative x-axis azimuth of the sonic into the program variable “sonic_azimuth”. If the sonic is installed such that it points into the prevailing wind, the negative x-axis is pointing into the prevailing wind. Take a compass azimuth of the negative x-axis (prevailing wind).

NOTE Don't forget to account for the magnetic declination at the site; see Appendix A for details.

2.3 Wiring

A Campbell Scientific Open-Path Eddy-Covariance system can take on several configurations and utilize several different dataloggers. It is impractical to document the different wiring schemes in this manual. However, each custom datalogger program (p/n 18442 or 18443) ships with a complete and detailed wiring diagram.

2.4 Power

The system requires about 1.5 to 6 W continuous power, depending on the datalogger and sensor configuration. The approximate power requirements of various key components, for a system running at 10 Hz, are listed in TABLE 2-1, TABLE 2-2, and TABLE 2-3.

TABLE 2-1. Nominal Sensor Power Requirements

Sensor	Power (mW)
IRGASON	400 mA @ 12.5 Vdc
IRGASON (gas head powered down)	240 mA @ 12.5 Vdc
KH20	10 - 20 mA @ 12.5 Vdc
HMP45C	<3.8 mA @ 12.5 Vdc

TABLE 2-2. Nominal Datalogger Power Requirements with the Display Off and No RS-232 Communications

Datalogger	Power (mW)
CR1000 w/ CFM100 & CF card	8 mA @ 12.5 Vdc
CR3000 w/ CFM100 & CF card	39 mA @ 12.5 Vdc
CR5000 w/ PC/CF card	63 mA @ 12.5 Vdc

TABLE 2-3. Nominal Datalogger Power Requirements with the Display and Backlight On, and No RS-232 Communications

Datalogger	Power (mW)
CR1000 w/ CFM100 & CF card	109 mA @ 12.5 Vdc
CR3000 w/ CFM100 & CF card	75 mA @ 12.5 Vdc
CR5000 w/ PC/CF card	170 mA @ 12.5 Vdc

The OPEC system is powered by an external power supply system. The power supply can be a Campbell Scientific PS84, a third party solar power supply system, or a user supplied power system.

With a Campbell Scientific PS84 solar power system, connect the OPEC sensor power cables to the positive and negative terminals of the power supply. For a third party power system, see the specific power supply system manual for installation and connection instructions.

Power connections are listed in the text files shipped with the datalogger programs (p/n 18442 or 18443). Be sure the datalogger has a good earth ground to provide maximum protection against voltage surges due to primary and secondary lightning strikes. Campbell Scientific recommends that all dataloggers in the field be earth grounded. All components of the system (datalogger, sensors, external power supplies, mounts, housing, etc.) must be referenced to one common earth ground. When long cables are used or a site has frequent lightning strikes, spark gaps may be required to protect the datalogger from transient voltages.

3. System Datalogger Program

The open-path eddy-covariance datalogger program integrates all of the sensors in an open-path eddy-covariance station into a single system. Part number 18442 is a program for a basic system and p/n 18443 is a program for an extended system (with energy balance sensors). Each program is custom written for the order. If your order did not include either p/n 18442 or 18443

as a line item on the order, contact Campbell Scientific to purchase the appropriate datalogger program for your open-path eddy-covariance system.

The program covers a variety of sensors and is continuously growing. If your system uses sensors that are not currently supported by the program, add the appropriate measurement and processing instructions to the program or contact Campbell Scientific for assistance. Campbell Scientific charges for custom datalogger programming with a one hour minimum and one hour resolution; call for current Application Engineering time rates.

The datalogger program aligns the measurements in time from the CSAT3, IRGASON, KH20, and FW05 before computing online fluxes. The IRGASON delay is a function of the user programmed bandwidth setting. The delay as a function of bandwidth is given in the IRGASON manual. The sensor delays are removed before the data is used to compute the online fluxes. These fixed delays are computed automatically by the datalogger program, based in the IRGASON bandwidth setting. The default IRGASON bandwidth is 20 Hz. The sensor delays are not removed from the high frequency time series data saved to Final Storage.

Depending on the system configuration, the datalogger programs compute carbon dioxide flux, latent heat flux, sonic sensible heat flux, sensible heat flux, momentum flux, and friction velocity, along with all the second moment covariances, standard deviations, and means. The program will also compute a sensible heat flux using the sonic temperature corrected for the effects of water vapor. This sensible heat flux can also be found from the sonic sensible heat flux and latent heat flux in post processing (see Appendix B).

3.1 Program Configuration

The site attendant must enter unique calibration coefficients or site-specific information into the datalogger program. This information includes, but is not limited to, the calibration coefficients for the net radiometer and soil heat flux plates, or site pressure. To find the section of the program where these changes are made, search for the text “Unique”. These values are added to the program before it is downloaded into the datalogger.

3.1.1 Sonic Azimuth

The example programs report the wind direction in both the sonic coordinate system (a right-handed coordinate system) and in the compass coordinate system (a left-handed coordinate system). The sonic coordinate system is relative to the sonic itself and does not depend on the sonic’s orientation (azimuth of the negative x-axis). The compass coordinate system is fixed to the earth. In order for the program to compute the correct compass wind direction, the azimuth of the sonic negative x-axis must be entered into the program. The program default value for the variable “sonic_azimuth” is 0. This assumes that the prevailing wind is from the North, e.g., the sonic is mounted such that the negative x-axis points to the North.

The variable “sonic_azimuth” can be changed on the fly using the CR3000 keyboard display or via LoggerNet. Once a “sonic_azimuth” is entered, the value is saved in the CPU. The program default “sonic_azimuth” is used only if a site specific value has not been entered using the keyboard or through LoggerNet.

To enter the “sonic_azimuth” using the datalogger keyboard, press the <Esc> key until the Campbell Scientific Inc. logo is visible in the upper left hand corner of the display. Press the <Enter> key. Select the menu “Sonic_Azmth” and press the <Enter> key. Enter the azimuth of the negative x-axis and press the <Enter> key. Press the <Esc> several times so that the Campbell Scientific logo is visible.

To enter the “sonic_azimuth” using LoggerNet, connect to the datalogger with LoggerNet and display the Public data table. Locate the variable “sonic_azimuth” and click on it. Double click on the number field, enter the negative x-axis azimuth and press the <enter> key.

NOTE

Don’t forget to account for the magnetic declination at the site; see Appendix A for details.

FIGURE 3-1 and FIGURE 3-2 show the orientation of an IRGASON azimuth bearing of 140 degrees, e.g., the negative x-axis is pointing into 140 degrees. If the wind is blowing into the sonic, from the negative x-axis to the positive x-axis (from the transducers to the block), the horizontal wind vector angle (*wind_dir_csat3*) is 0 degrees (wind vector) and the compass wind direction (*wnd_dir_compass*) is 140 degrees (wind vane).

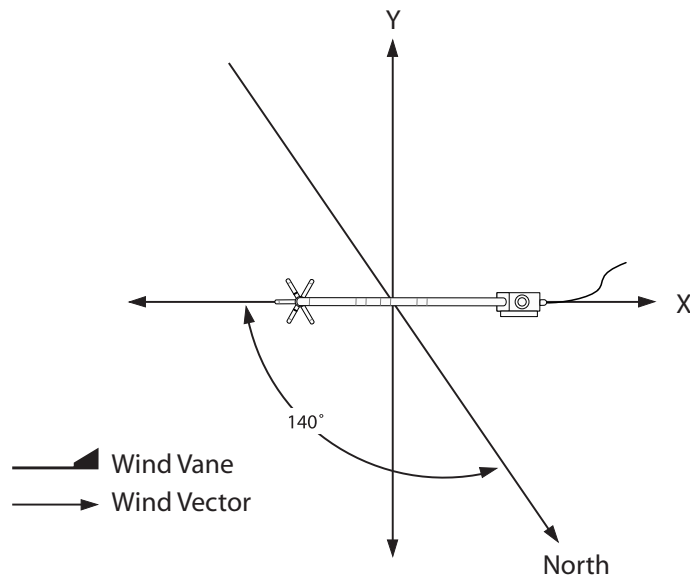

FIGURE 3-1. IRGASON right hand coordinate system, horizontal wind vector angle is 0 degrees

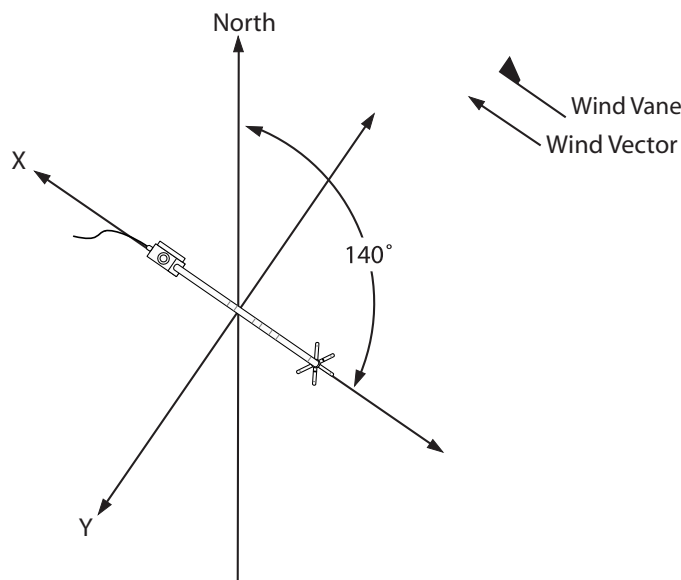

FIGURE 3-2. Compass coordinate system, compass wind direction is 140 degrees

3.1.2 Sensor Configuration

The IRGASON communicates with Campbell Scientific dataloggers using a digital communication protocol called Synchronous Device for Measurement (SDM). Each sensor connected to the SDM bus has a unique address. A maximum of 15 addresses are allowed by the protocol and each sensor must have a unique SDM address.

CAUTION

Do not use SDM address F (15) because it is reserved for use with the Group Trigger instruction.

The IRGASON is shipped from the factory is set with a default SDM address of 1. This address is set in software and can be changed using the software DevConfig or ECMon and a USB cable. DevConfig is sensor/peripheral support software shipped with LoggerNet. ECMon is PC support software shipped with the IRGASON and is also available in the downloads section online at www.campbellsci.com.

The program sets the IRGASON bandwidth to 20 Hz. The instrument delay is a function the bandwidth setting and is automatically computed by the datalogger program. To use a bandwidth other than 20 Hz, change the program constant "BANDWIDTH" to the appropriate value. For more information on IRGASON bandwidth and delay see the IRGASON manual.

NOTE

The settings are sent to the IRGASON each time it is powered on and only if connected to the datalogger via SDM. The settings are not saved onto the IRGASON's non-volatile memory.

CAUTION If you loan an IRGASON to a colleague, verify that the address is 1 before deploying the system into the field.

3.2 Loading a Program to the Datalogger

Before the datalogger can begin to make measurements, a program must be transferred into its CPU. The program can be transferred using a PC and LoggerNet or using PC/CF cards.

3.2.1 Direct Connection via LoggerNet

The datalogger program can be transferred to a datalogger using a PC, LoggerNet, and some sort of interface. In the eddy-covariance application, the most common interface is the RS-232 cable.

TIP To avoid potential problems (mixed data and connectivity issues), configure LoggerNet with one station file per datalogger, even if the data is retrieved using cards and the computer is connected to multiple dataloggers for monitoring purposes only. See the LoggerNet manual Section 4.2.

Set up a station in the LoggerNet network map; see Section 4.1 in the LoggerNet manual for details. To transfer a program to the datalogger, start LoggerNet. Click on the “Connect” button in the Toolbar. Select the station and click on the “Connect” button. Check the datalogger time, it is located in the upper right hand side of the Connect Screen. If the datalogger and PC time differ by more than a few seconds, set the datalogger time by clicking on the “Set Station’s Clock” button. To download a program, click on the “Send” button. Navigate to the folder where the program is saved, select it, and click on “OK”.

3.2.2 Remote via PC/CF Card

The datalogger program can be transferred to a datalogger using a PC/CF card. The CRBasic dataloggers reserve 10% or 80 Kbytes of space, whichever is smaller, on cards to store programs. Copy the program onto the card using Windows Explorer.

CAUTION Use only PC/CF Cards sold by Campbell Scientific Inc. Although consumer versions of PC/CF cards will fit into the card slot and operate, only the PC/CF cards carried by Campbell Scientific have passed our temperature and electrostatic discharge (ESD) testing.

The following instructions assume a basic familiarity in the operation of a CRBasic datalogger keyboard; see the datalogger manual for details on using the keyboard.

Insert the card into the datalogger card slot. Press the <Enter> key. If necessary, select the “System Menu” menu and press the <Enter> key. Select the “File” menu and press the <Enter> key. Select the “Copy” menu and press the <Enter> key. The cursor should be at the “From” line. Press the <Enter>

key, select “CRD:” and again press the <Enter> key. The datalogger will now display a list of program files on the card.

Navigate to the eddy-covariance program and press the <Enter> key. The cursor will jump to the “To” line. Press the <Enter> key and then the right arrow, select CPU:filename. Press the <Esc> key and down arrow. Finally, press the <Enter> key to execute the copy from the card to the CPU.

To start the program, press the <Esc> key until the main menu appears and Campbell Scientific logo appear in the upper left hand side. Press the <Enter> key, if necessary, select the “System Menu” and press the <Enter> key. Select the “Run/Stop Program” menu and press the <Enter> key. Tag the “Restart, Delete Data” option, navigate to “Execute” and press the <Enter> key. Select “Yes” and press the <Enter> key.

CAUTION Do not run a program from the PC/CF card if the card will be removed and replaced with another.

3.3 System Operation

Once the program is downloaded to the datalogger, compiled, and the PC/CF card has been formatted, the datalogger will begin to communicate with the SDM sensors and measure the analog sensors. At the top of the next minute, it will start writing the raw time series data to the PC/CF card (the LED will begin to pulse at a regular interval). Verify that all the sensors are wired and measured correctly by monitoring the Public data table. Check the Status data table for compile and runtime errors (see Section 3.3.2).

3.3.1 Monitoring Data

Monitor the instantaneous measurements and diagnostics by viewing the “Public” table. The “Public” tables can be monitored using either LoggerNet (see the LoggerNet manual for details) or via the keyboard and display (see the datalogger manual for details). The online flux computations can be viewed by monitoring the “Flux” table with either LoggerNet or the keyboard and display. The historical online “Flux” data can be monitored in “Final Storage Data” menu.

3.3.2 Status Table

The “Status” table contains useful information about the performance and status of the system (see Appendix A in the datalogger manual). To view the “Status” table with LoggerNet, go to the Connect Screen and select the Tools | Status Table ... menu (see Section 5.1.10 in the LoggerNet manual). With the keyboard display, follow this menu path System Menu | Status. Useful information in the “Status” table includes, but is not limited to:

OSVersion: Version and revision of the CRBasic datalogger operating system. As of the printing of this document, Campbell Scientific recommends using, CR3000 OS v25.0, CR1000 OS v25.0, or CR5000 OS v6.0 or greater.

WatchdogErrors: Number of times the watch dog timer reset the datalogger. Normally, this count should be 0.

CompileResults: Reports compile errors.

VarOutOfBound: An element of an array was referenced that does not exist, e.g., a VarOutOfBound is reported if element wind(9) is referenced in the program, but the array was defined with 5 elements.

SkippedScan: If the maximum number of buffered scans is exceeded (defined in the third parameter of the Scan () instruction), the Processing and Measurement tasks are resynchronized. The resynchronization results in a number of SkippedScan equal to the buffer depth.

DataFillDays(): The number of days to fill a table in both the CPU and CRD memory. The number of days to fill a table is reported in the same order they are found in the “Status” table, e.g., the same order they are defined in the program.

CardStatus: Indicates if a card is used by the program or not.

ProcessTime: Time, in microseconds, it takes the datalogger to complete all the processing. In the Sequential mode, this value must always be less than the Scan Interval. In the PipeLine mode, this value can occasionally be greater than the Scan Interval, e.g., when the 30 minute fluxes are computed. With the Eddy-Covariance systems, always use the Pipeline mode.

BuffDepth: The current number of Scans that the datalogger Processing tasks have fallen behind the Measurement tasks. In the Pipeline Mode, the datalogger processing task can periodically fall behind the Scan Interval.

MaxBuffDepth: The maximum number of Scans that the Processing tasks have fallen behind the Measurement tasks.

4. Data

Each system requires an Open-Path Eddy-Covariance program (p/n 18442 or 18443). The data table outputs of the programs are described in a Microsoft® Excel document (shipped with the program). The description includes the variable name and units. There is one sheet (tab) per output.

NOTE

The datalogger programs are protected under U.S. and International copyright laws. Do not distribute the datalogger programs. See the End User License Agreement (EULA) shipped with the programs for more information on your rights and obligations.

Data is saved on the PC/CF card as a binary file in a Campbell Scientific format called Table Oriented Binary Format 3 (TOB3). TOB3 incorporates features to improve reliability of the card and allows for the accurate determination of each record’s time without the space required for individual time stamps.

Before the data can be used, it must be converted to a Table Oriented Binary Format 1 (TOB1), Table Oriented ASCII Format 5 (TOA5), or Array Compatible CSV file. In all of these formats, the time stamp is written to each record. In the TOB1 format, the time stamp is reported as the number of

seconds and nanoseconds since 0000 hrs, 1 Jan 1990. In the TOA5 format, the time stamp is a quoted string, similar to that used in Microsoft® Excel. In the Array Compatible CSV, time is reported as elements of the array, e.g., in the same format as the Campbell Scientific mixed array dataloggers.

NOTE

Campbell Scientific recommends the use of TOB1 file format. This file format can be readily read into third party post processing software, e.g., EdiRe or MatLab. If required, a TOB1 flux file can be converted into a TOA5 flux file using CardConvert. A TOA5 file is comma separated values and easily read into Microsoft® Excel as a CSV file.

Both the TOB1 and TOA5 formats contain an ASCII header. This header contains information about the datalogger used to collect the data. The header also describes the data with variable names and units. For more information on the file formats, see Section 2.4 in the datalogger manual.

For backwards compatibility with mixed array dataloggers, comma separated values, without header information, is also supported with LoggerNet and CardConvert. Elements that contain an array ID, day of year, hour and minutes, can be added to the first few columns of the data file. This format is supported in LoggerNet version 3.3 and CardConvert version 1.2 or greater.

4.1 Data Retrieval

Data can be collected from a datalogger using both LoggerNet and a direct connection, or by physically moving the card from the datalogger to the computer. Using LoggerNet and a PC as a data retrieval option is only practical if the PC will be located at the site and is continuously polling the datalogger because the volume of data is such that it takes about 8% to 25% of real time to download 10 Hz time series data.

Transferring data using the PC/CF card is relatively fast; however, it does require manual intervention to manage the files. A 1024 Mbyte file (about 28 days of 10 Hz time series from a basic open-path eddy-covariance system) will take about 15 minutes to copy from the card to a PC hard drive.

A basic Open-Path Eddy-Covariance system will collect about 40 Mbytes of 10 Hz time series data per day. A strategy for maintaining manageable file sizes is to break them up into smaller files that cover time periods ranging from 1 hour to 1 day. This can be achieved with LoggerNet and the Baler, or using CardConvert. Both the Baler and CardConvert support naming these smaller files using the time stamp of the first record in the file.

TIP

A group file renaming utility can be useful to manage files from multiple stations. These utilities are commonly used in the photography industry to manage image files and are readily available on the web, ranging from freeware, shareware, and commercial versions. Any one of these will meet the data file management needs, as long as it can find and replace text within a file name.

4.1.1 Direct Connection Data Retrieval via LoggerNet

LoggerNet can be used to automatically collect and organize data from an Open-Path Eddy-Covariance system. This approach is somewhat limited because of the slow throughput into the PC's RS-232 port. For all practical purposes, the PC must remain continuously connected to the datalogger. It will take about 8% to 25% of real time to collect 10 Hz time series data, e.g., it will take between 5 to 15 minutes to download 60 minutes of 10 Hz time series data. Using a PC and LoggerNet to “milk” data from remote sites is not practical.

For sites where a PC is continuously connected to the datalogger via RS-232, MD-485 short haul modems, Freewave spread spectrum radios, Ethernet connection, or other “direct connection”, LoggerNet and the Baler can be used to collect and manage the data.

To create a new station file see Section 4.2 of the LoggerNet manual. Configure the station's “Data Files” tab as shown in FIGURE 4-1 and FIGURE 4-2. Note that the “File Output Option” is “No Output File”. LoggerNet will collect the data from the data table and place it in the cache. The cache is where data collected from the datalogger is stored and made available for use by client software, e.g., the Baler. Client software is run on the host PC or a remote PC. For more information, see Section 13.1 of the LoggerNet manual.

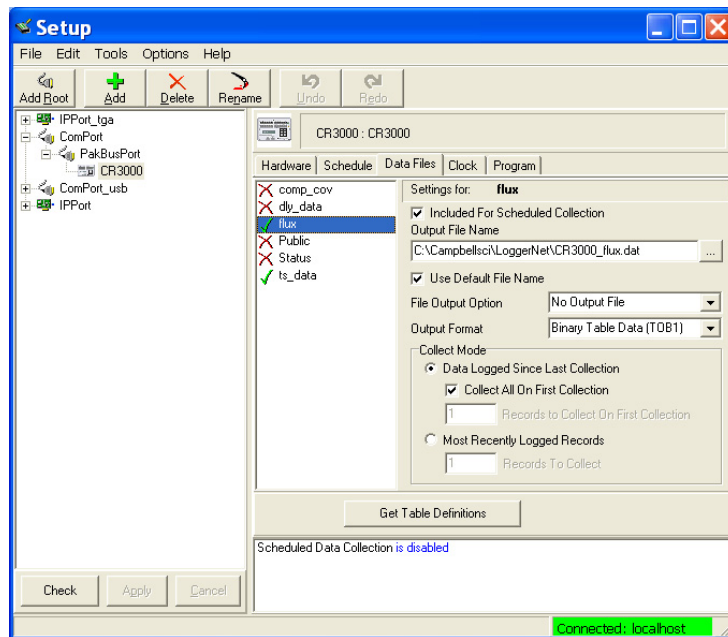

FIGURE 4-1. LoggerNet station setup for the “flux” table

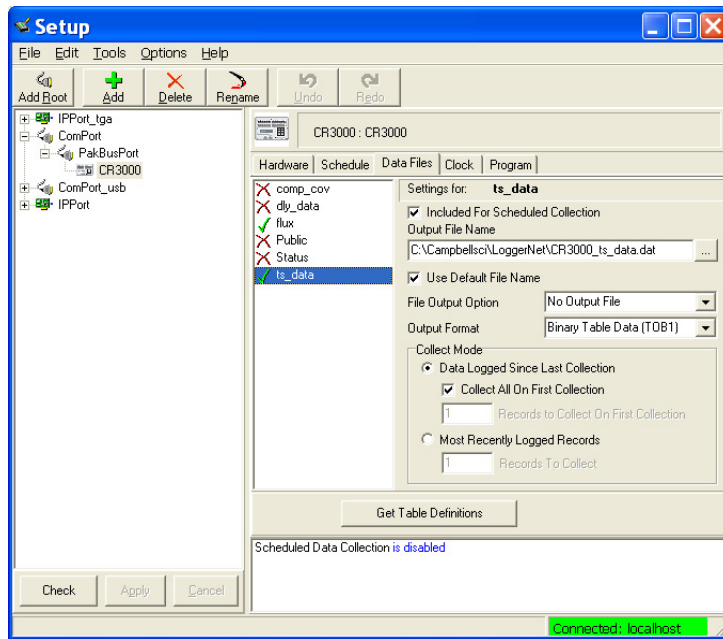

FIGURE 4-2. LoggerNet station setup for the “ts_data” table

In the “Schedule” tab, configure the station’s data collection as shown in FIGURE 4-3. Modify the Primary Retry Interval, Number of Primary Retries, and the Secondary Retry interval as needed for the specific telecommunications option used at the station. For example, a site using Freewave spread spectrum radios or an Ethernet connection may require a long interval between retries or more frequent retry attempts because of other background traffic.

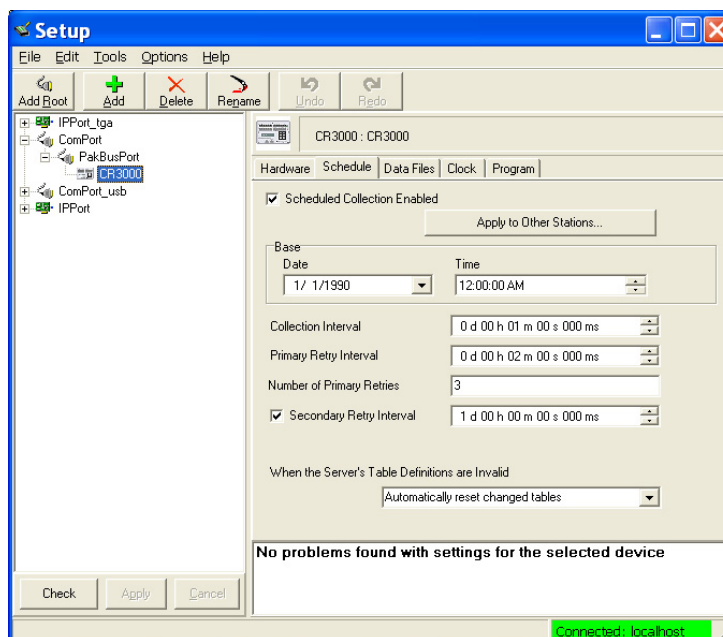

FIGURE 4-3. LoggerNet station data collection schedule

To enable LoggerNet’s data collection, click on the Status Monitor button in the Toolbar. Select the station and click on the “Toggle On/Off” button. The time of the next data collection will appear in the “Next Data Call” column (see FIGURE 4-4). To display additional station information, right click on any column header and then Select “Column...”. For more information, see Section 6.1 Status in the LoggerNet manual.

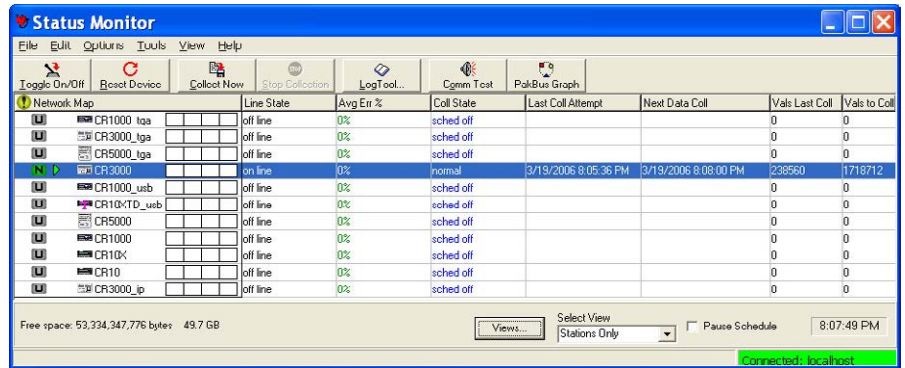

FIGURE 4-4. LoggerNet station status monitor

4.1.2 File Management with Baler

The data is collected by LoggerNet and placed in the LoggerNet cache. Two instances of the Baler, one for the time series data and the other for the flux data, will pull the data from the cache and “bale” it into a user specified file size (see FIGURE 4-5 and FIGURE 4-6). Campbell Scientific recommends using a one hour bale size for time series data that will be post processed by EdiRe and a 1 day bale size for the flux data. To run more than one instance of the Baler, use the “/WorkDir=*pathname*” switch and two shortcuts, one for the time series data and the other for the flux data (see Section 6.5 in the Baler manual).

TIP While the system is set up in the lab or outside near the lab, practice not only operating the system and data collection, but also file management and data processing. Only through this type of experimentation will you determine the file sizes and procedures that work best for you.

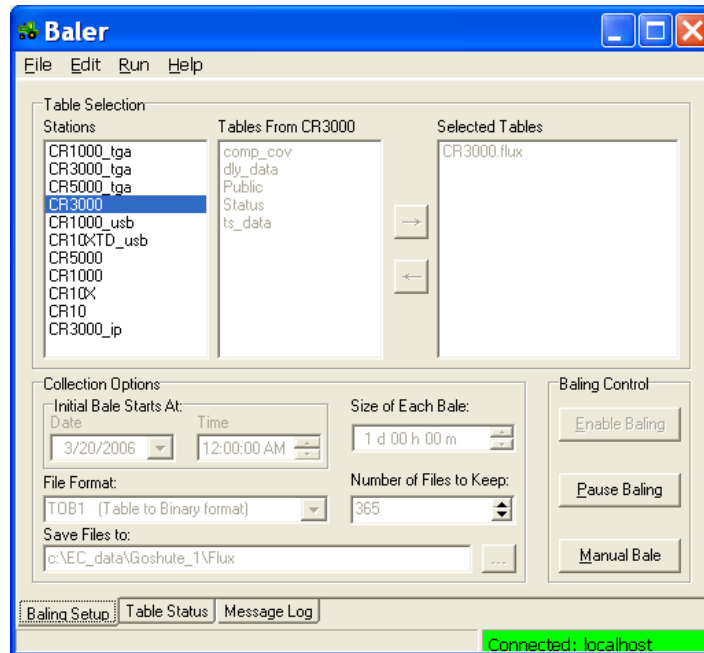

FIGURE 4-5. Baler station setup for the “flux” table

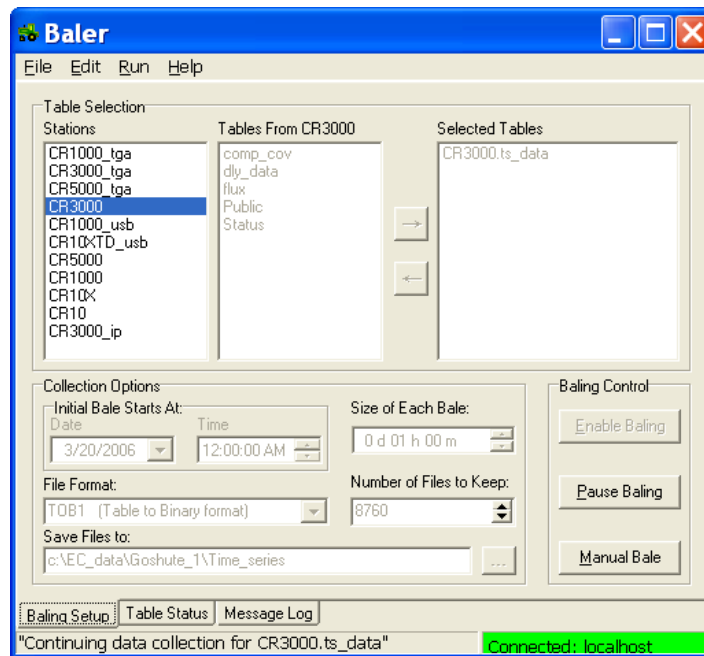

FIGURE 4-6. Baler station setup for the “ts_data” table

4.1.3 Remote Data Retrieval via a PC/CF Card

To transfer data manually from the PC/CF card to the PC, remove the card from the datalogger following the proper card removal procedure (see the appropriate datalogger manual for details). Insert a fresh card into the datalogger or copy the data from the card to a working directory on the computer. Transferring data using the PC/CF card is relatively fast. A 1024 Mbyte file (about 28 days of 10 Hz time series data) will take about 15 minutes to copy from the card to a PC hard drive.

While the PC/CF card is not in the datalogger, the datalogger will continue to collect and save the data in the CPU. When the card is returned to the datalogger, the data will be transferred automatically from the CPU to the card.

NOTE

When a card is inserted into a CRBasic datalogger, the datalogger will transfer all the data that was collected since the card was removed. It is good practice to avoid keyboard and RS-232 activity during this time. After the datalogger is finished transferring the data to the card, the LED will blink at a steady frequency.

The amount of CPU storage, for time series data, varies from data logger to datalogger. The Status Table reports the time it takes to fill the CPU and CRD DataTables in the "DataFillDays" fields. The third DataFillDays field is the fill time for the CPU time series data table.

CAUTION

Never remove a PC/CF card from the datalogger or turn off power to the datalogger without first shutting down the card. With a CR3000 or CR1000, press the "Removal Button" on the CFM100 Compact Flash/NL115 Ethernet/Compact Flash module. With a CR5000 select the PCCard|Remove Card menu.

Data can be retrieved from a datalogger using one or two cards. If a single card is used, and data on the card is not deleted after copying it to the PC, the data from the CPU will be appended to the file on the card when it is returned to the datalogger. Using a single card in this fashion allows the site attendant to create files of uniform size.

The disadvantage of this approach, if the time between site visits is significantly less than the DataTable file time, is that there will be redundant data copied, along with the new data. This approach is not practical if the PC can not be brought to the site or the time it takes to copy the data from the card to the PC is greater than the time it takes to fill the CPU time series DataTable.

As an alternative, two cards can be used. The site attendant will remove the card in the datalogger and replace it with a fresh one. This method is fast and does not require a PC at the site. The disadvantage of this approach is that it will create non-uniform file sizes around the time that the cards are exchanged. If the time series data is processed by EdiRe, nonuniform file sizes are not an issue. The files could be spliced together using the Append option in CardConvert.

4.1.4 File Management with CardConvert

CardConvert is a utility that is shipped with LoggerNet and is used to convert the files on a card from the compact file format TOB3 to a TOB1, TOA5, or Array Compatible CSV (see FIGURE 4-7). This utility is installed on the PC under the Start menu in the Programs | Campbell Scientific | LoggerNet | Utilities group. To take advantage of all the functionality described in this section, use CardConvert version 1.2 or later.

Copy the data from the PC/CF card onto the computer using Windows Explorer. Place the file in a temporary working directory, e.g., C:\Temporary. It will take about 15 minutes to copy a 1024 Mbyte file (about 28 days of 10 Hz time series from a Basic Open-Path Eddy-Covariance system).

TIP

It is good practice to archive the raw data as copied from the PC/CF card. Use a zip utility to compress the file, before archiving it to a CD. Compressing a 1024 Mbyte time series file will take about 2 minutes using the built-in Windows XP zip utility.

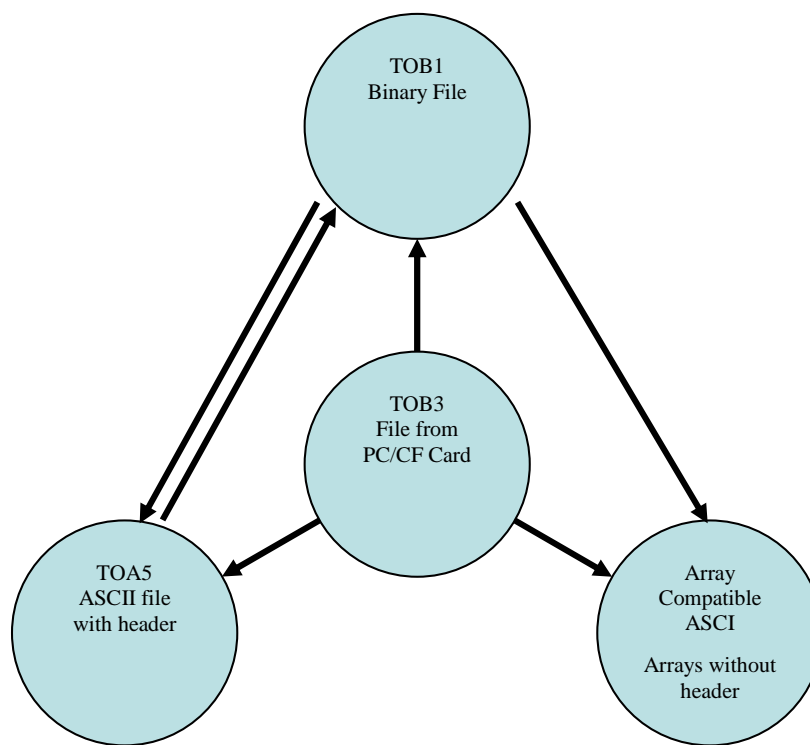

FIGURE 4-7. File format flow

Start the CardConvert utility. When CardConvert is started, a summary of its current settings is displayed in the lower right hand screen. There are four screens/parameters to setup and configure in CardConvert. Once configured, CardConvert will save these settings in the Windows Registry. In subsequent runs, only the default Output File name must be changed.

- Click on the “Select Card Drive” button and navigate to the temporary directory that contains the raw time series and flux data files. Select the drive and click on the “OK” button.

TIP

Since it is likely that the online flux and time series files will be broken down into different sizes based on time, process the time series and flux data with multiple passes through CardConvert.

- Click on the “Change Output Dir” button and navigate to the folder to store the processed data. Select the drive and click on the “OK” button.
- Click on the “Destination File Options” button, the Destination File Option screen will appear. Configure the screen as shown in FIGURE 4-8 and then click on the “OK” button.

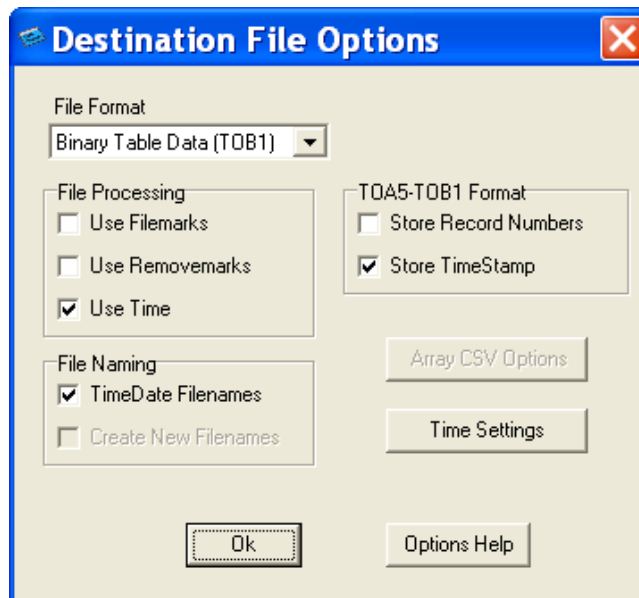

FIGURE 4-8. Destination File Option screen

TIP

To create an EdiRe raw format file list using the Interpreter, save the data in the TOB1 file format. If another format is needed at a later date, convert the TOB1 files into the other file format (see FIGURE 4-7).

- Set the file size (Bale size) in the “Time Settings” screen. For the time series files, use a one hour file size and for the online flux data, use a one day file size.

TIP Practice converting the data from the card and processing it with your off-line tools. Only through this type of experimentation will you determine the file sizes that work best for you.

- Finally, change the output file name. The default output file name is TOB1_stationname.ts_data.dat, where *stationname* is the datalogger’s station name and can be set using DevConfig.exe (part of LoggerNet). The factory default station name is the datalogger serial number. Right click on the *stationname.ts_data* file and select “Change Output File”.

NOTE If any other parameters are later changed, CardConvert will return to the default output file name.

- Click on the “Start Conversion” to start the conversion process (FIGURE 4-9).

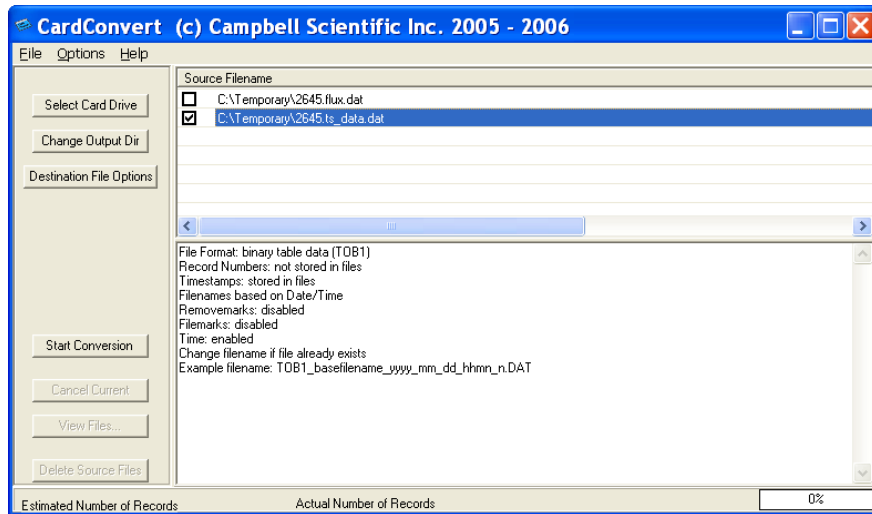

FIGURE 4-9. Fully configured CardConvert start up screen

The converted files will look something like the 20 Hz files shown in FIGURE 4-10. Each file name will consist of a user specified file name and the time stamp of the first record in each file with a one minute resolution. Note that the first file and last file in the folder are smaller than the rest. This is because they do not contain a complete hour of data.

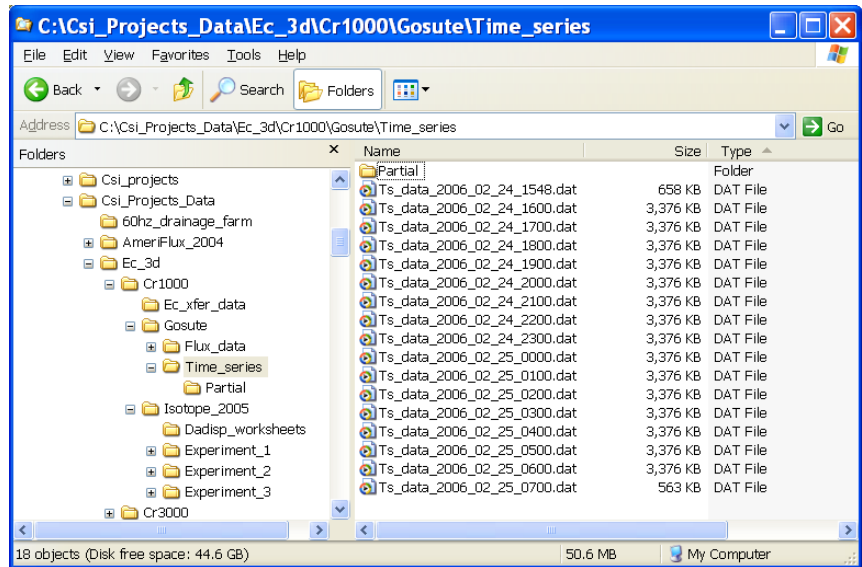

FIGURE 4-10. List of files created by CardConvert

4.1.4.1 Collecting Data with One Card

If a single card is used to collect the data and the data on the card is not deleted after copying it to the PC, the datalogger will append the data collected since the card was removed to the data file on the card. This means that the next time data is collected and converted from the PC/CF card, the last file in FIGURE 4-10 will contain a complete hour of data.

Before collecting data for the second and subsequent time, rename the last partial file from ..._0700.dat to ..._0700_1.dat. This will ensure that the complete version of this file is saved to the folder.

CardConvert will not overwrite existing files within a folder. Instead, it will append a “_n” to the filename, where n is a numeral. FIGURE 4-11 shows the name change to duplicate files. Note that the duplicate files get mixed in with the original files within the folder. Rename the duplicate file using a group file renaming utility. Specifically, find and replace the text “_1.dat” with “.bak”. Sort the files in the folder by extension and delete the “bak” files (see FIGURE 4-12).

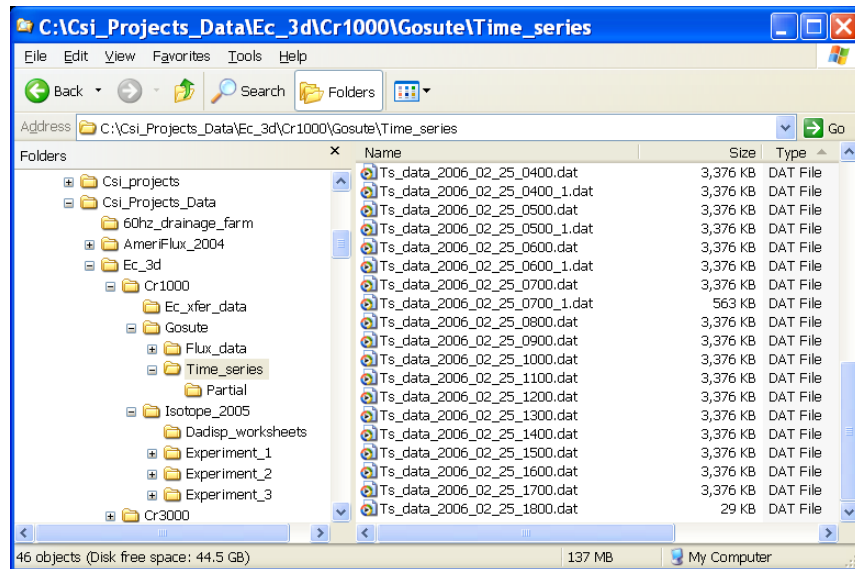

FIGURE 4-11. List of files created by CardConvert with duplicates

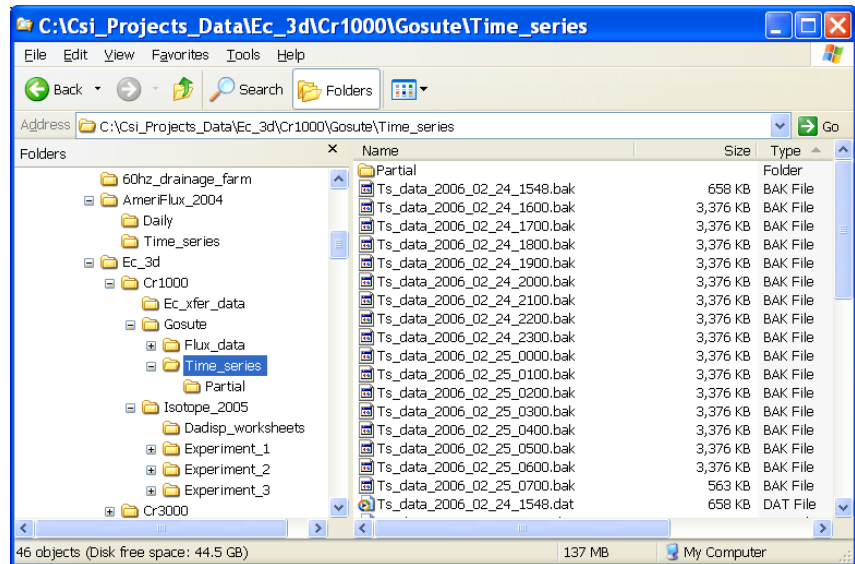

FIGURE 4-12. List of files where the duplicate files are renamed to *.bak

4.1.4.2 Collecting Data with Two Cards

Data can be collected using two cards. The card in the datalogger is removed and replaced with an empty one. The data from the original card is copied to the computer at some later time.

NOTE

Using two or more cards is a fast and efficient method of collecting data. Only new data is collected; however, two partial files within a “baling” period are created. Variable file lengths are not an issue with EdiRe.

Again, note that the first and last files (FIGURE 4-13) are smaller than the rest of the files. The next time data is retrieved from the datalogger, the file Ts_data_2000_02_25_0700.dat will be continued in another file (FIGURE 4-14).

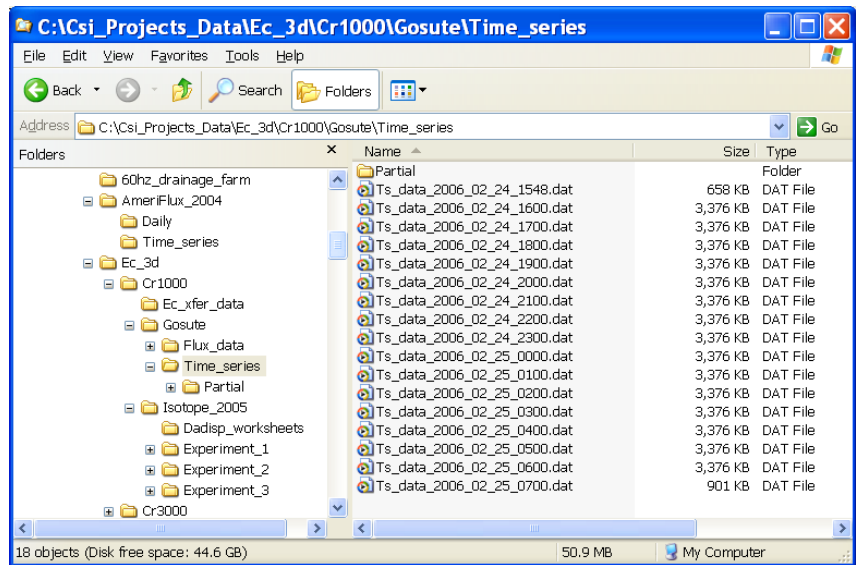

FIGURE 4-13. List of files collected the first time using two cards

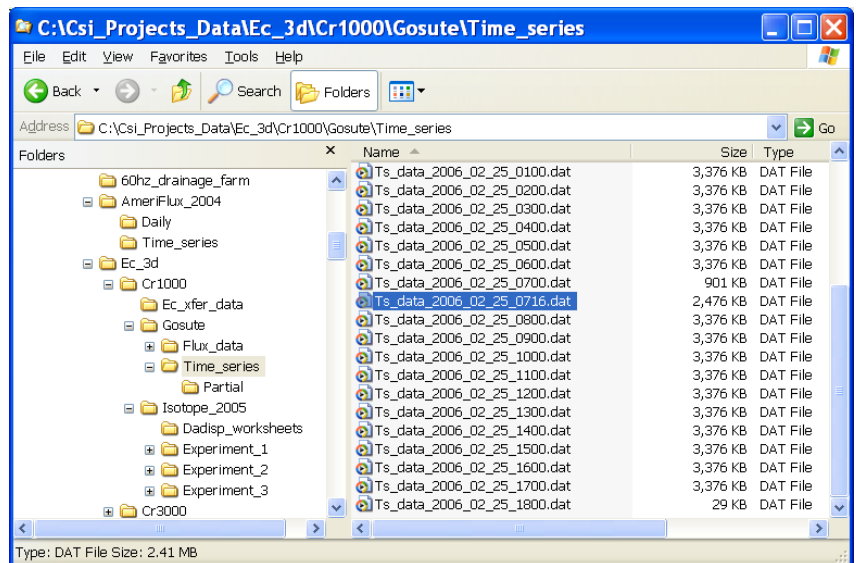

FIGURE 4-14. List of files collected the second time using two cards

4.2 Data Processing

There are several ways to process the raw time series data collected by the system. Some of these are considered standard by the community and others are subject to much debate. To gain a better understanding of the issues, review the literature.

4.2.1 Online Processing

The Open-Path Eddy-Covariance datalogger programs perform the processing listed below online and in real time. In many cases, no further processing of the data is required.

- Thirty minute statistics for the turbulence and meteorological variables, these include fluxes, means, and standard deviations. The output period can be changed by changing the Constant OUTPUT_PERIOD.
- Compute the mean moist air density, temperature, and vapor pressure. Air density is used to compute the sensible heat and momentum flux.
- Webb et al. (1980) term for latent heat flux and CO₂ flux. This term is separated into its two components, e.g., one term for temperature and the other for vapor density.
- Wind direction and wind speed from the sonic anemometer.
- Compute the KH20 Krypton Hygrometer oxygen correction.
- Cross-products (second moments) required for an off-line coordinate rotation following Kaimal and Finnigan (1994) and Tanner and Thurtell (1969).

NOTE

The datalogger programs do not apply a coordinate rotation to the data.

4.2.2 Off-line Processing with EdiRe

EdiRe is a powerful and flexible software package for processing Eddy-Covariance data collected by a Campbell Scientific system. It is available at no charge from the University of Edinburgh's ftp site (<http://www.geos.ed.ac.uk/abs/research/micromet/EdiRe/Downloads.html>). EdiRe can, using the Interpreter, read TOB1 data files. EdiRe will sort the input data files by date and time, and can deal with files that are not the same size, e.g., collected using two cards.

Some of the available EdiRe processing functions are:

- Statistics for the turbulence and meteorological variables, these include means, standard deviations, and covariances.
- Filtering the data (detrending, recursive, FIR, exponential).

- Spatial separation correction or maximum covariance.
- Coordinate rotation (mean vertical wind = 0 or planar fit).
- Spectral analysis.
- Wavelet analysis.
- Webb et al. (1980) term for latent heat flux and CO₂ flux. This term is separated into its components due to temperature and to vapor density fluctuations.
- Wind direction and wind speed from the sonic anemometer.
- KH20 Krypton Hygrometer oxygen correction.

There is a certain level of complexity inherent in any software package with EdiRe's flexibility. At the University of Edinburgh ftp site you will find an online user forum (<http://www.geos.ed.ac.uk/abs/research/micromet/EdiRe/EdiReForum/>), FAQ (http://www.geos.ed.ac.uk/abs/research/micromet/EdiRe/Help_information.html), and tutorials (<http://www.geos.ed.ac.uk/abs/research/micromet/EdiRe/Tutorials/>).

Along with the information on the University of Edinburgh's ftp site, see the EdiRe online help and the Campbell Scientific Application Note on using EdiRe. EdiRe lends itself to experimentation. The best way to learn how to use EdiRe is to experiment with it.

NOTE

EdiRe is not a Campbell Scientific product. Campbell Scientific provides limited support of EdiRe, specifically in reading in TOB1 data files. If further support is required, contact the support personnel listed at <http://www.geos.ed.ac.uk/abs/research/micromet/edisol/edicontact.htm>.

4.2.2.1 Creating Raw File Format and Processing Lists

Start EdiRe, select the Processing | Interpreter menu. Fill out the Interpreter screen as shown in FIGURE 4-15. In the "Sample file" pull down menu, navigate to the folder that contains the raw time series data and select one of the TOB1 files (FIGURE 4-16). Do the same for the "Format list file name" and "Processing List file name". After the Interpreter screen is filled out, it should look something like FIGURE 4-17. Now click on the "Create" button.

EdiRe will estimate the data collection frequency and display this estimate in a pop-up window. The estimate will be wrong because EdiRe includes the header information as data records in the file. Enter the correct data collection frequency (FIGURE 4-18). Now, click on "OK" and then "OK" again. EdiRe will create and load the format and processing lists.

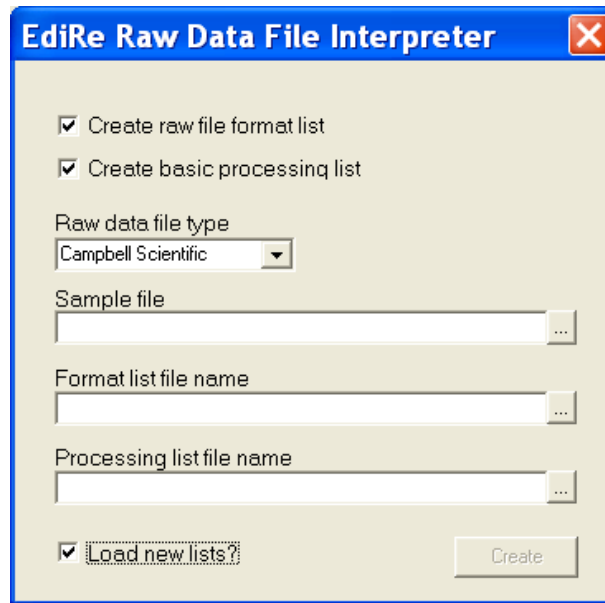

FIGURE 4-15. Interpreter settings to read a Campbell Scientific TOB1 data file

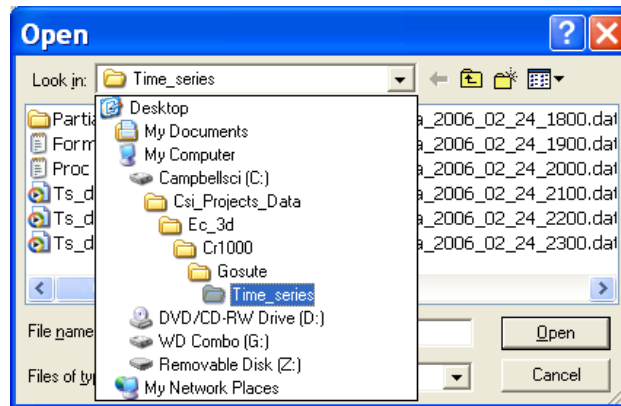

FIGURE 4-16. Folder that contains the raw TOB1 time series data files

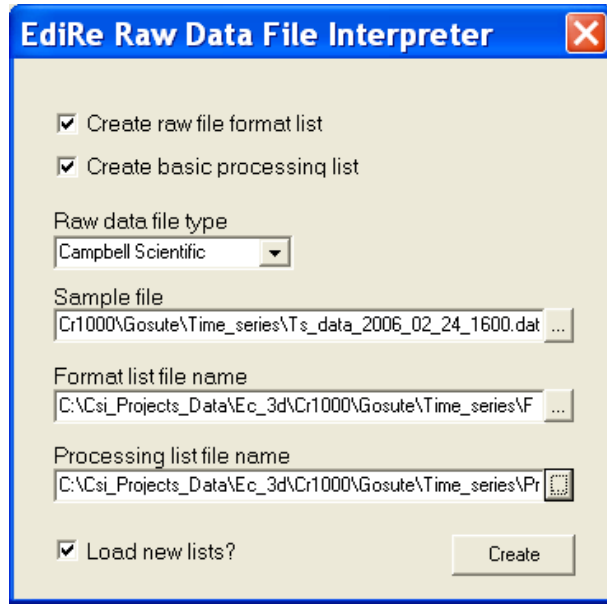

FIGURE 4-17. Completed Interpreter screen

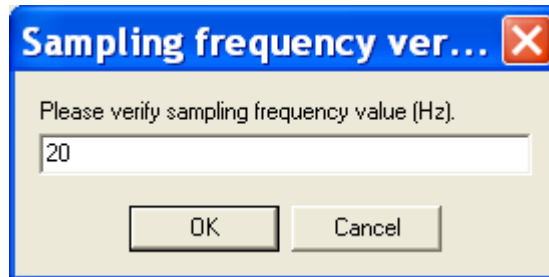
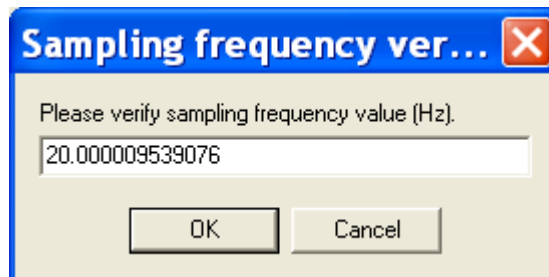

FIGURE 4-18. Estimated sample frequency and correct sample frequency

4.2.2.2 Example EdiRe Raw File Format and Processing Lists

To view the Lists in EdiRe, select the Processing | Options menu. The “Raw File Format” list. The default “Processing Steps” list must be modified for your specific application.

The Processing Steps list has the default instructions needed to extract the data from the TOB1 file (FIGURE 4-19). Additional instructions can be found in the “Processing Items” list. To configure the instruction, select the instruction parameter and enter values either from the “Processing Item Parameter” pull down menu, or enter output variable names in the “Processing Item Parameter” field using the keyboard.

The location of the output files, as comma separated values, can be specified in the “Output Files” tab or as part of the processing list with the “Location Output Files” instruction (FIGURE 4-20).

TIP Campbell Scientific recommends incorporating the output file destination as part of the processing list rather than changing the output file name in the “Output File” tab. This will prevent the accidental merger of results from multiple stations.

The mean and standard deviation of a variable is found using the “1 Chn Statistics” instruction, covariances and fluxes are found using the “2 Chn Statistics” instruction. The results of the processing can be plotted with the “Plot Value” instruction, see FIGURE 4-21, FIGURE 4-22, and FIGURE 4-23.

Other useful instructions are: Rotation Coefficients, Rotation, Remove Lag, Cross Correlate, Wind Direction, Raw Subset, Set Value, Comments, User Defined, User Defined Fast, and Webb Correction. For additional information on EdiRe and its use, see the online help and the EdiRe application note published by Campbell Scientific

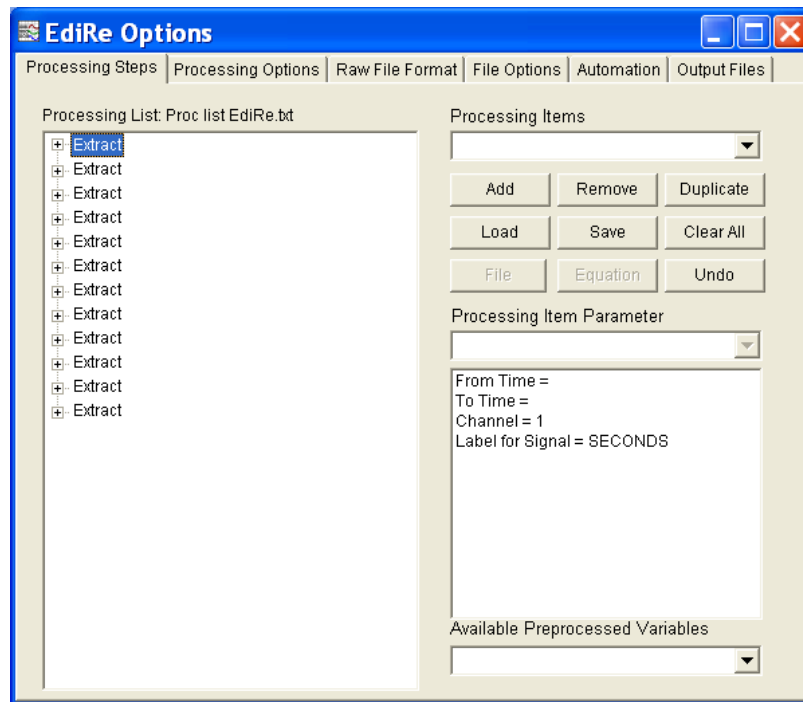

FIGURE 4-19. Default EdiRe processing list created by the Interpreter

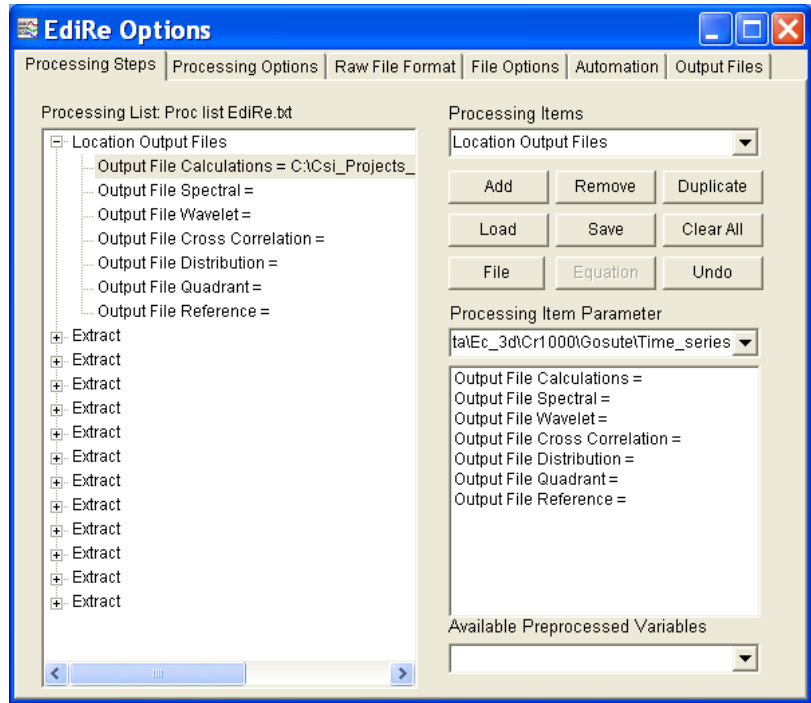

FIGURE 4-20. Output file location as part of the processing list

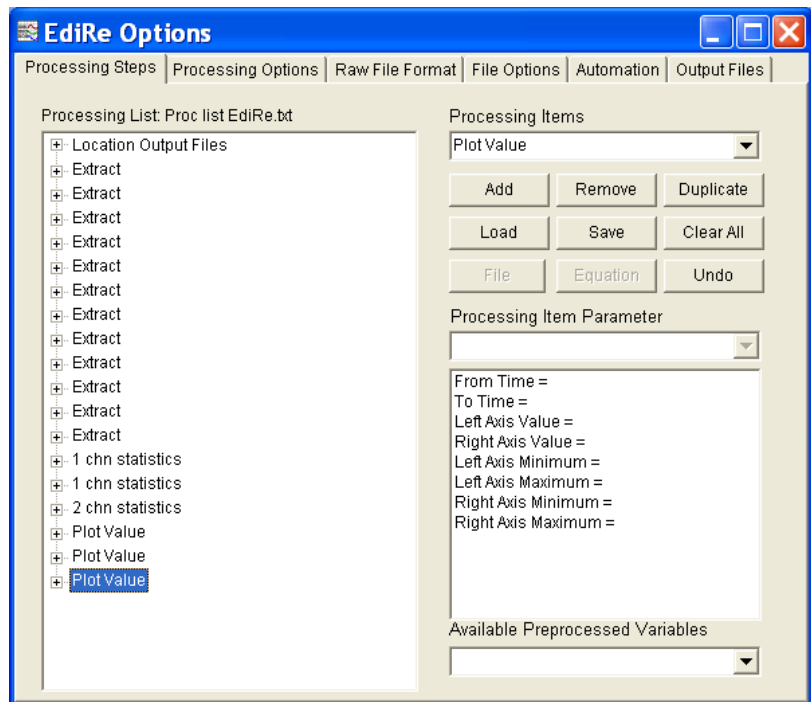

FIGURE 4-21. Output file location as part of the processing list

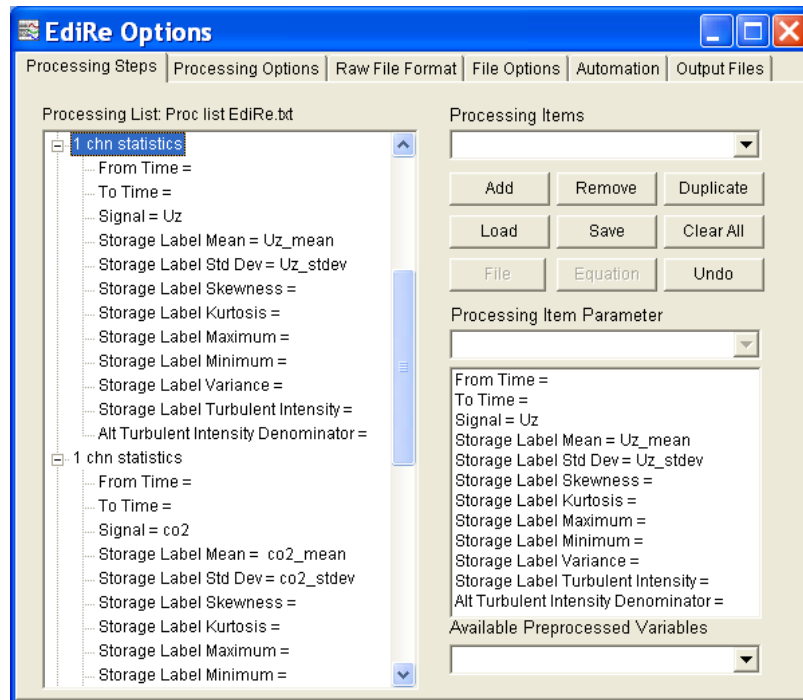

FIGURE 4-22. Processing U_z and CO_2 with 1 Chn Statistics instruction

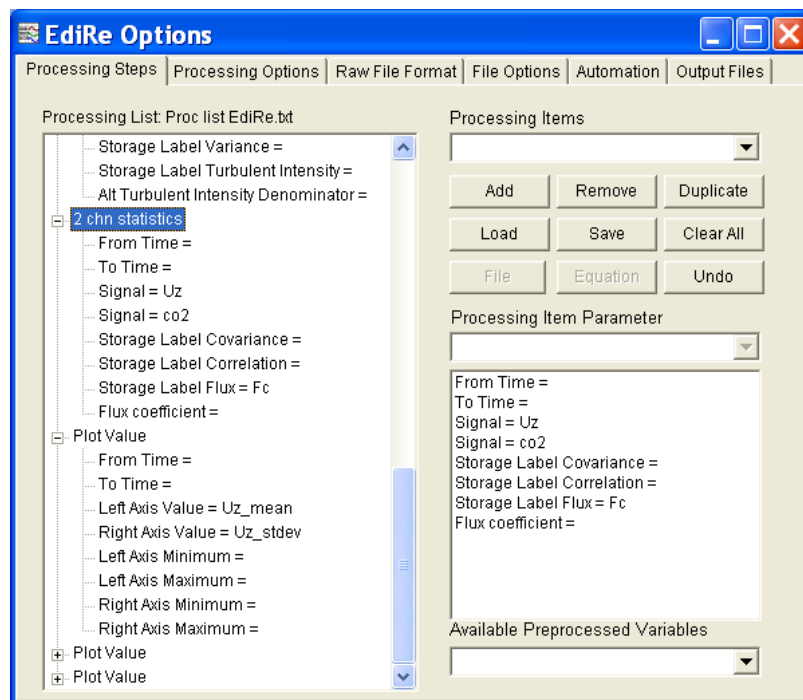

FIGURE 4-23. Computing CO_2 flux with 2 Chn Statistics and graphing U_z statistic with Plot Value instruction

5. Basic Eddy-Covariance Theory

Appendix B lists several references on eddy-covariance flux measurements. The following text books are particular informative:

Atmospheric Boundary Layer Flows, Their Structure and Measurement (Kaimal and Finnigan, 1994)

A Brief Practical Guide to Eddy Covariance Flux Measurements: Principles and Workflow Examples for Scientific and Industrial Applications (Burba and Anderson, 2010)

Eddy Covariance, A Practical Guide to Measurement and Data Analysis (Abuinet et al., 2012)

Handbook of Micrometeorology. A Guide for Surface Flux Measurements and Analysis (Lee et al., 2004)

Workshop on Micrometeorology (Haugen, 1973)

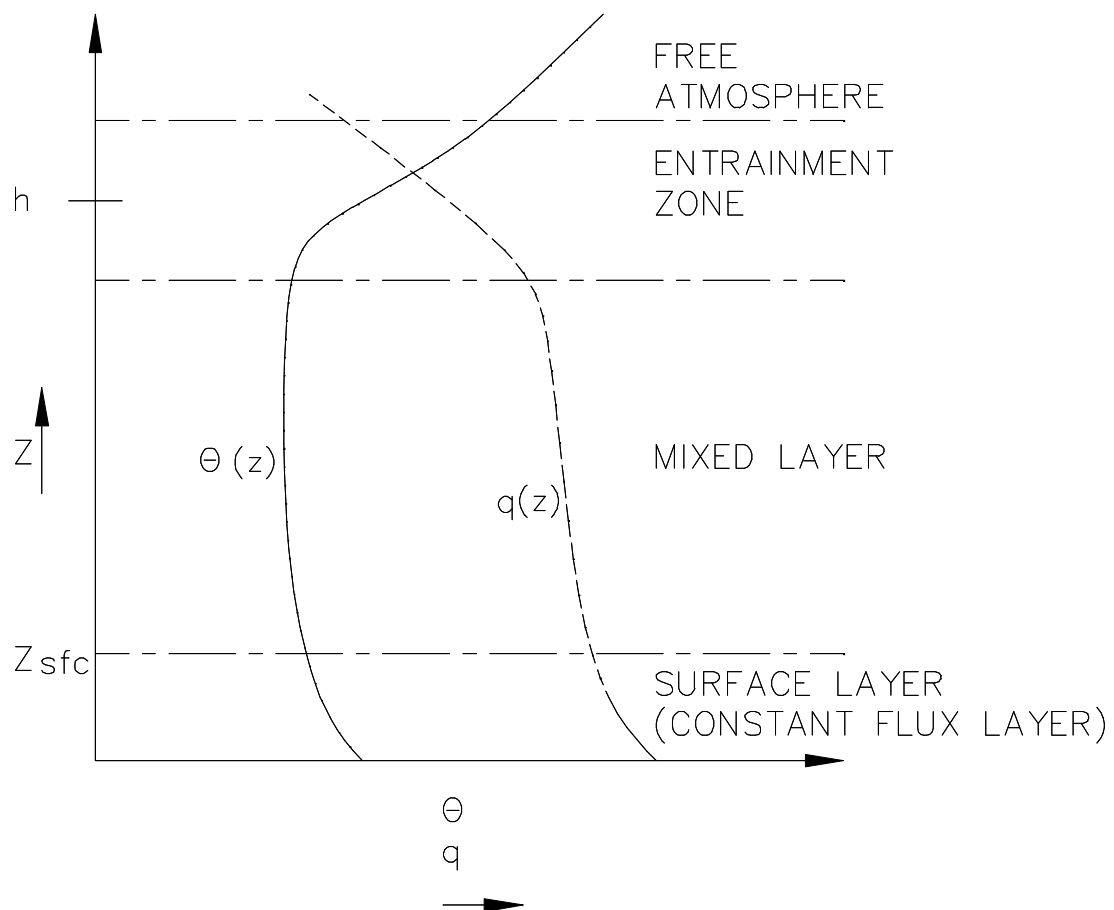

FIGURE 5-1. Ideal vertical profiles of virtual potential temperature and specific humidity depicting all the layers of the atmospheric boundary layer

The surface layer (FIGURE 5-1) is comprised of approximately the lower 10% of the atmospheric boundary layer (ABL). The fluxes of water vapor and heat within this layer are nearly constant with height when the following criteria are met: the surface has approximate horizontal homogeneity; and the relationship $z/h \ll 1 \ll z/z_{om}$ is true, where z_{sfc} is the height of the surface layer, h is the height of the ABL, and z_{om} is the roughness length of momentum. When the above conditions are met, the flux of carbon dioxide, water vapor and heat, within the surface layer, may be written as:

$$F_c = \overline{\rho'_c U'_z} \quad (1)$$

$$LE = L_v \overline{\rho'_v U'_z} \quad (2)$$

$$H = \rho_a C_p \overline{T' U'_z} \quad (3)$$

where F_c is the carbon dioxide flux, ρ'_c is the instantaneous deviation of the carbon dioxide density from the mean, U'_z is the instantaneous deviation of vertical wind speed from the mean, LE is the latent heat flux, L_v is the latent heat of vaporization, ρ'_v is the instantaneous deviation of the water vapor density from the mean, H is the sensible heat flux, ρ_a is the density of air, C_p is the heat capacity of air at a constant pressure, T' is the instantaneous deviation of air temperature from the mean (Stull, 1988; Massman et al., 2004).

The quantities $\overline{\rho'_c U'_z}$, $\overline{\rho'_v U'_z}$, and $\overline{T' U'_z}$ are the covariances between vertical wind speed and carbon dioxide density; vertical wind speed and vapor density; and vertical wind speed and temperature. These quantities are computed online by the CRBasic datalogger as are the cross products (second order moments) required to apply a post processing coordinate rotation following Kaimal and Finnigan (1994) and Tanner and Thurtell (1969).

The Open-Path Eddy-Covariance system directly measures latent and sensible heat flux. If net radiation and soil heat flux are also measured, energy balance closure may be examined using the surface energy balance equation:

$$R_n - G = H + LE \quad (4)$$

where R_n is the net radiation and G is the total soil heat flux. H , LE , and G are defined as positive away from the surface and R_n is positive toward the surface; F_c is defined, following the micrometeorological sign convention, as positive away from the surface.

If a FW05 finewire thermocouple is not part of the system, the sensible heat flux (H_c) can be computed from the vertical wind and humidity corrected sonic temperature.

Appendix A. CSAT3 Orientation

A.1 Determining True North and Sensor Orientation

The orientation of the CSAT3 negative x-axis is found by reading a magnetic compass and applying the site-specific correction for magnetic declination; where the magnetic declination is the number of degrees between True North and Magnetic North. Magnetic declination for a specific site can be obtained from a USGS map, local airport, or through a NOAA web calculator (Section A.2). A general map showing magnetic declination for the Conterminous United States in 2004 is shown in FIGURE A-1.

Magnetic Declination for the U.S. 2004

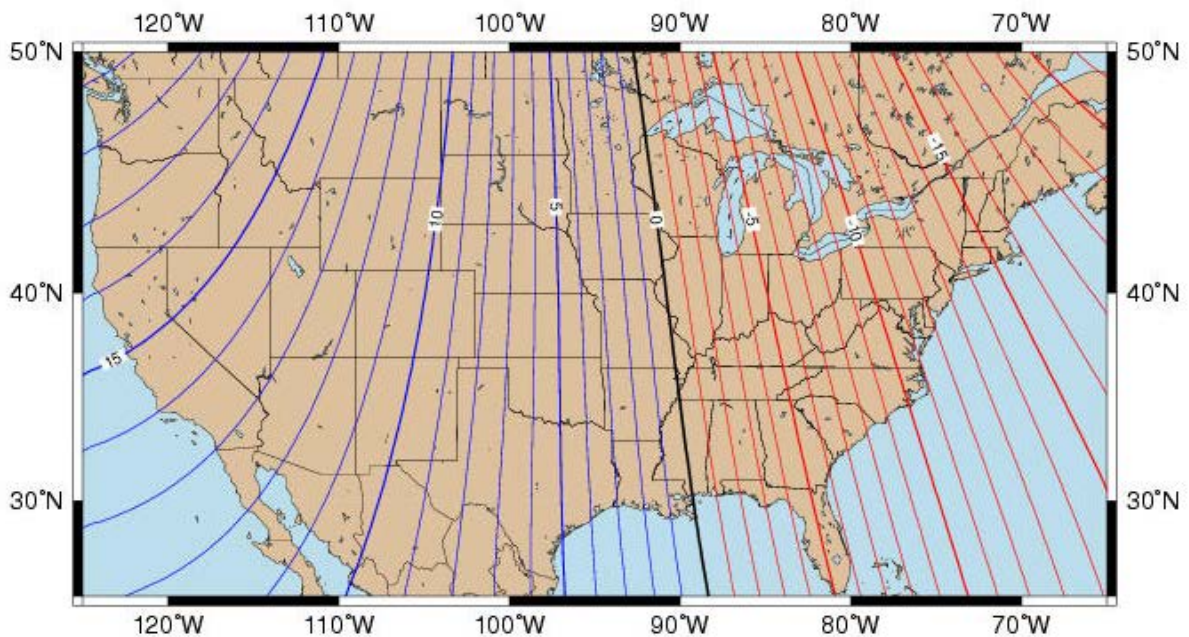

Mercator Projection

Contours of Declination of the Earth's magnetic field. Contours are expressed in degrees.
Contour Interval: 1 Degree (Positive declinations in blue, negative in red)

Produced by NOAA's National Geophysical Data Center (NGDC), Boulder, Colorado

<http://www.ngdc.noaa.gov>

Based on the International Geomagnetic Reference Field (IGRF), Epoch 2000 updated to December 31, 2004

The IGRF is developed by the International Association of Geomagnetism and Aeronomy (IAGA), Division V

FIGURE A-1. Magnetic declination for the conterminous United States (2004)

Declination angles are always subtracted from the compass reading to find True North. A declination angle East of True North is reported as positive a value and is subtracted from 360 (0) degrees to find True North as shown in FIGURE A-2. A declination angle West of True North is reported as a negative value and is also subtracted from 0 (360) degrees to find True North as shown in FIGURE A-3. Note that when a negative number is subtracted from a positive number, the resulting arithmetic operation is addition.

For example, the declination for Longmont, CO (10 June 2006) is 9.67° , thus True North is $360^\circ - 9.67^\circ$, or 350.33° as read on a compass. Likewise, the declination for Mc Henry, IL (10 June 2006) is -2.68° , and True North is $0^\circ - (-2.68^\circ)$, or 2.68° as read on a compass.

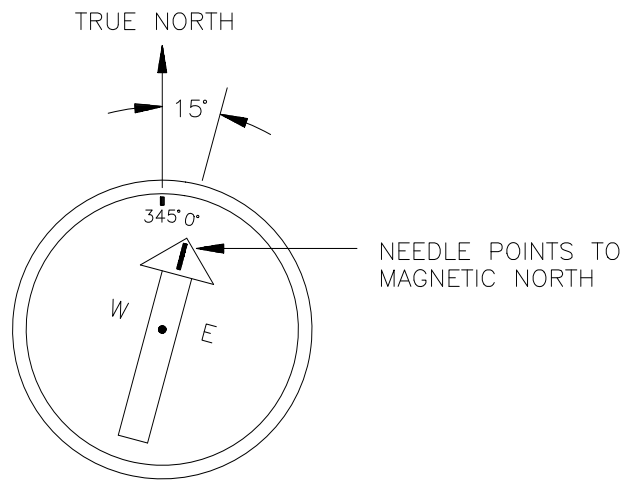

FIGURE A-2. A declination angle East of True North (positive) is subtracted from 360 (0) degrees to find True North

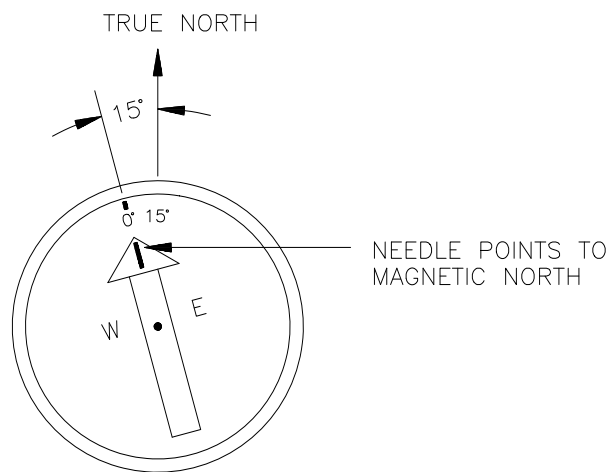

FIGURE A-3. A declination angle West of True North (negative) is subtracted from 0 (360) degrees to find True North

A.2 Online Magnetic Declination Calculator

The magnetic declination calculator web calculator published by NOAA's Geophysical Data Center is available at the following url <http://www.ngdc.noaa.gov/seg/geomag/jsp/struts/calcDeclination>. After the web page loads, enter the site zip code, or longitude and latitude, then click on the "Compute Declination" button (FIGURE A-4).



FIGURE A-4. Online magnetic declination calculator with inputs and output for Longmont, CO

The declination for Longmont, CO is 9.67 degrees (10 June 2006). As shown in FIGURE A-4, the declination for Colorado is positive (east of north), so true north for this site is $360 - 9.67$, or 350.33 degrees. The annual change is 8 minutes/year or 8 minutes west per year.

Appendix B. References

- Abuinet, M., Vesala, T., and Papale, D. (eds), 2012: *Eddy Covariance, A Practical Guide to Measurement and Data Analysis*, Springer, New York, 438 pp.
- Brutsaert, W.: 1982, *Evaporation into the Atmosphere*, D. Reidel Publishing Co., Dordrecht, Holland, 300.
- Buck, A. L.: 1976, "The Variable-Path Lyman-Alpha Hygrometer and its Operating Characteristics", *Bull. Amer. Meteorol. Soc.*, **57**, 1113-1118.
- Burba, G. G., and Anderson, D. J., 2010: *A Brief Practical Guide to Eddy Covariance Flux Measurements: Principles and Workflow Examples for Scientific and Industrial Applications*, LI-COR Biosciences, Lincoln, 211 pp.
- Campbell, G. S., and Tanner, B. D.: 1985, "A Krypton Hygrometer for Measurement of Atmospheric Water Vapor Concentration" *Moisture and Humidity*, ISA, Research Triangle Park, North Carolina.
- Dyer, A. J. and Pruitt, W. O.: 1962, "Eddy Flux Measurements Over a Small Irrigated Area", *J. Applied Meteorol.*, **1**, 471-473.
- Fleagle, R. G. and J. A. Businger, 1980: *An Introduction to Atmospheric Physics*. Academic Press, 432 pp.
- Gash, J. H. C.: 1986, "A Note on Estimating the Effect of a Limited Fetch On Micrometeorological Evaporation Measurements", *Boundary-Layer Meteorol.*, **35**, 409-413.
- Haugen, D. A. (ed), 1973: *Workshop on Micrometeorology*, American Meteorological Society, Boston, 392 pp.
- Kaimal, J. C. and J. A. Businger, 1963: A continuous wave sonic anemometer-thermometer, *J. Appl. Meteorol.*, **2**, 156-164.
- Kaimal, J. C. and Finnigan, J. J.: 1994, *Atmospheric Boundary Layer Flows, Their Structure and Measurement*, Oxford University Press, New York, 289 pages.
- Kaimal, J. C. and J. E. Gaynor, 1991: Another look at sonic thermometry, *Bound.-Layer Meteorol.*, **56**, 401-410.
- Mortensen, N. G., 1994: Flow-response characteristic of the Kaijo Denki omni-direction sonic anemometer (TR-61V), Riso-R-704(EN), Riso National Laboratory, Roskilde, Denmark.
- Lee, X., Massman, W., and Law, B. E. (eds.), 2004: *Handbook of Micrometeorology. A Guide for Surface Flux Measurements and Analysis*, Kluwer Academic Publishers, Boston, 250 pp.

- Schotanus, P., F. T. M. Nieuwstadt, and H. A. R. de Bruin, 1983: Temperature measurement with a sonic anemometer and its application to heat and moisture fluxes, *Bound.-Layer Meteorol.*, **26**, 81-93.
- Schuepp, P. H., Leclerc, M. Y., MacPherson, J. I., and Desjardins, R. L.: 1990, "Footprint Prediction of Scalar Fluxes from Analytical Solutions of the Diffusion Equation", *Bound.-Layer Meteorol.*, **50**, 355-373.
- Shuttleworth, W. J.: 1992, "Evaporation" (Chapter 4), in Maidment (ed), *Handbook of Hydrology*, Mc Graw-Hill, New York, 4.1-4.53.
- Stull, R. B.: 1988, *An Introduction to Boundary Layer Meteorology*, Kluwer Academic Publishers, Boston.
- Tanner, C. B. and Thurtell, G. W.: 1969, Anemoclinometer measurements of Reynolds stress and heat transport in the atmospheric surface layer, Final Report, United States Army Electronics Command, Atmospheric Sciences Laboratory, Fort Huachuca, Arizona.
- Tanner, B. D.: 1988, "Use Requirements for Bowen Ratio and Eddy Correlation Determination of Evapotranspiration", Proceedings of the 1988 Specialty Conference of the Irrigation and Drainage Division, ASCE, Lincoln, Nebraska, 19-21 July 1988.
- Wallace, J. M. and P. V. Hobbs, 1977: *Atmospheric Science: An Introductory Survey*. Academic Press, 350 pp.
- Warland, J. S., Dias, G. M., and Thurtell, G. W.: 2001, "A Tunable Diode Laser System for Ammonia Flux Measurements over Multiple Plots" *Environ. Pollut.*, **114**, 215-221.
- Webb, E.K., Pearman, G. I., and Leuning, R.: 1980, "Correction of Flux Measurement for Density Effects due to Heat and Water Vapor Transfer", *Quart. J. Roy. Meteor. Soc.*, **106**, 85-100.

Appendix C. OPEC200 Open Path Eddy Covariance System Quickstart Guide

1. Setup tripod and mount enclosures.

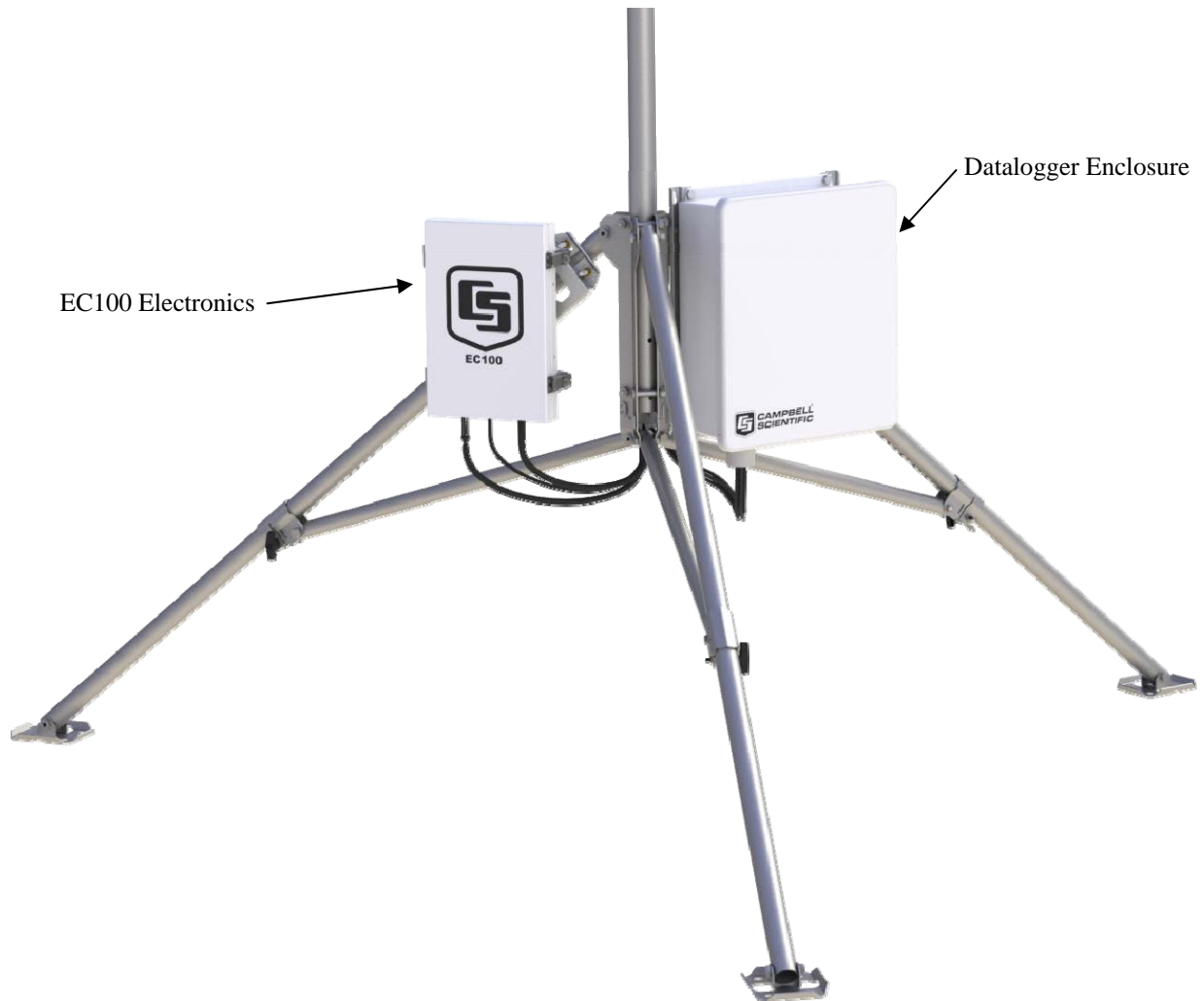

2. Ground tripod and enclosures.

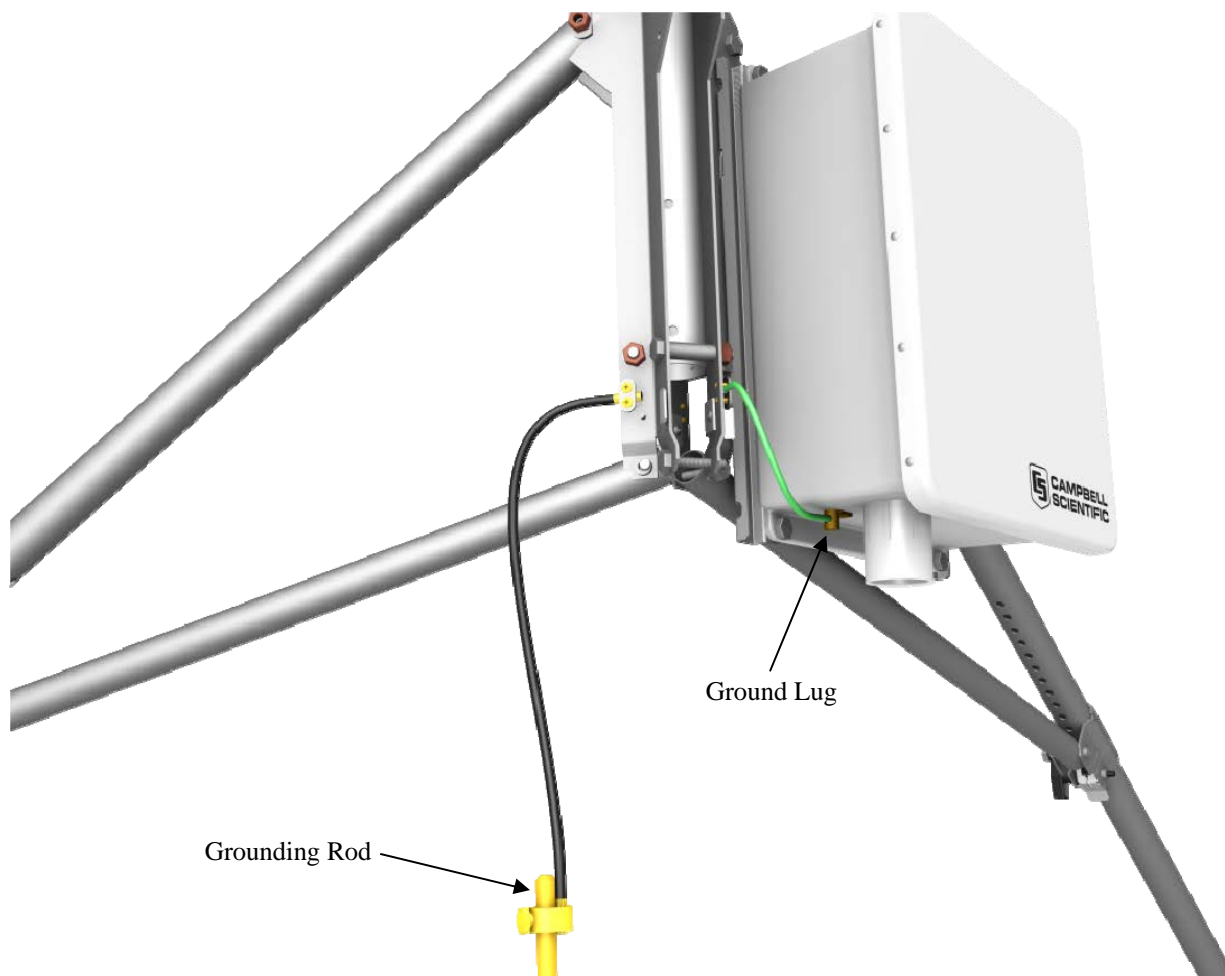

3. Setup tripod or mast with CM20X Crossarm.

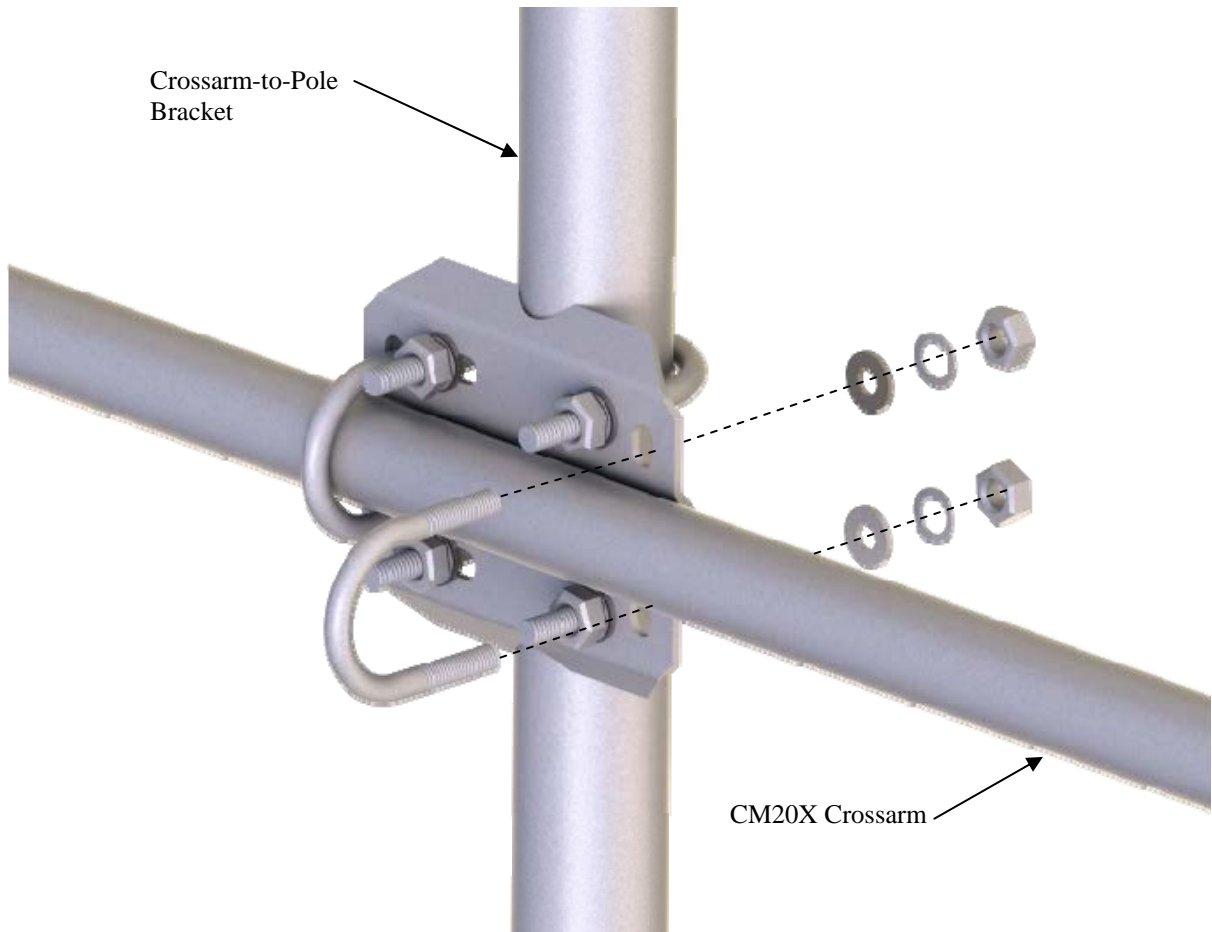

4. Mount the IRGASON into the prevailing wind.

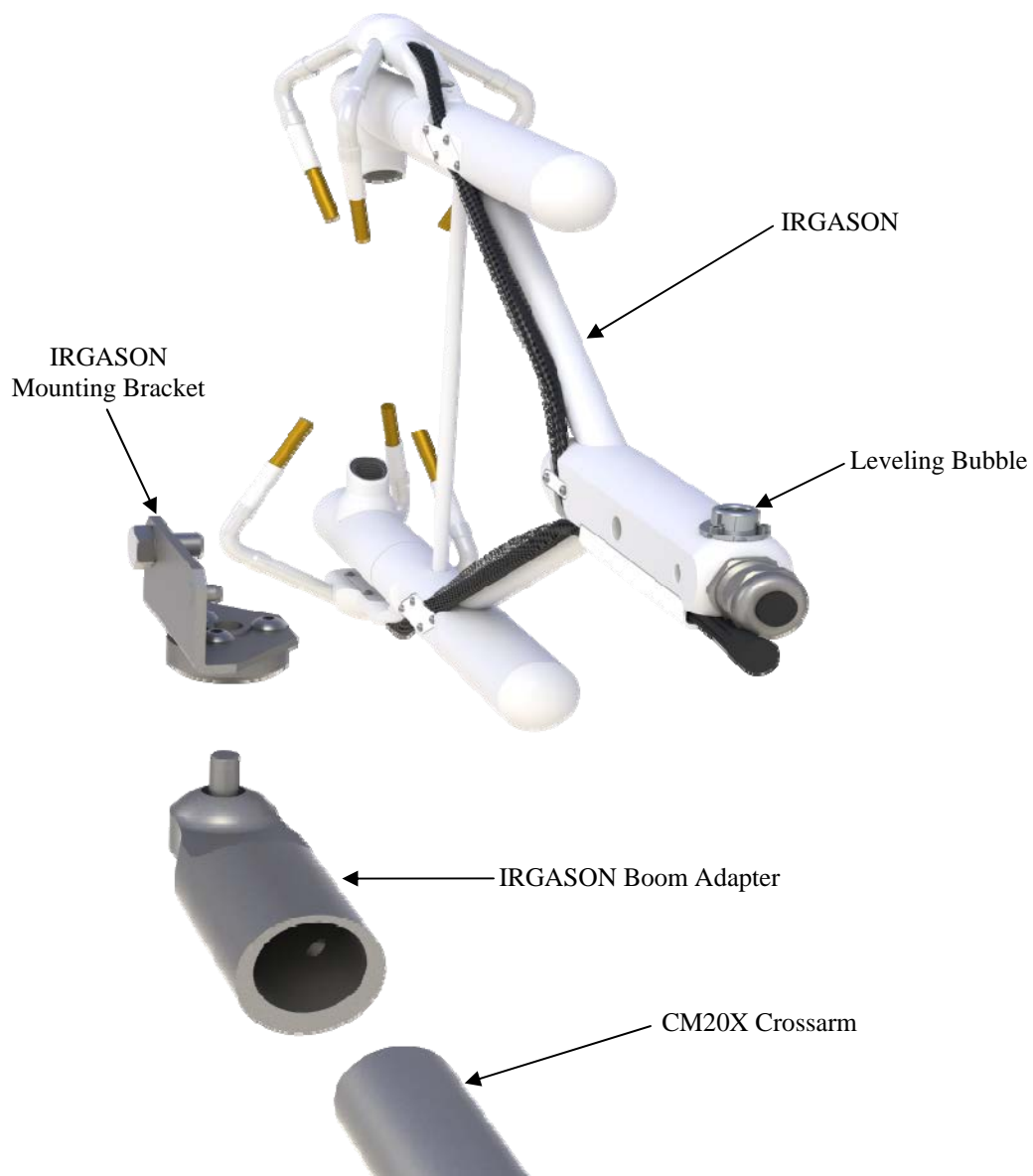

5. Mount the radiation shield and IRGASON Temperature Probe.

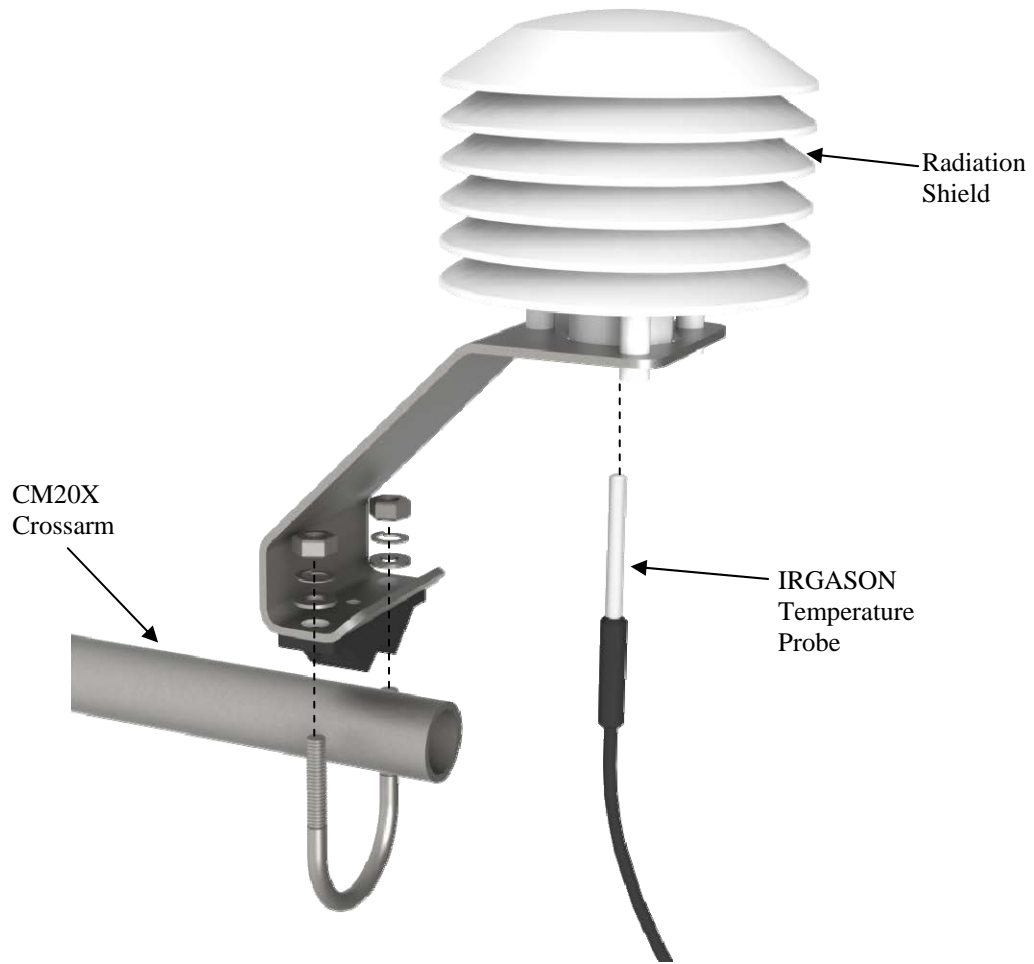

7. Connect system wiring and insert compact flash (CF) card.

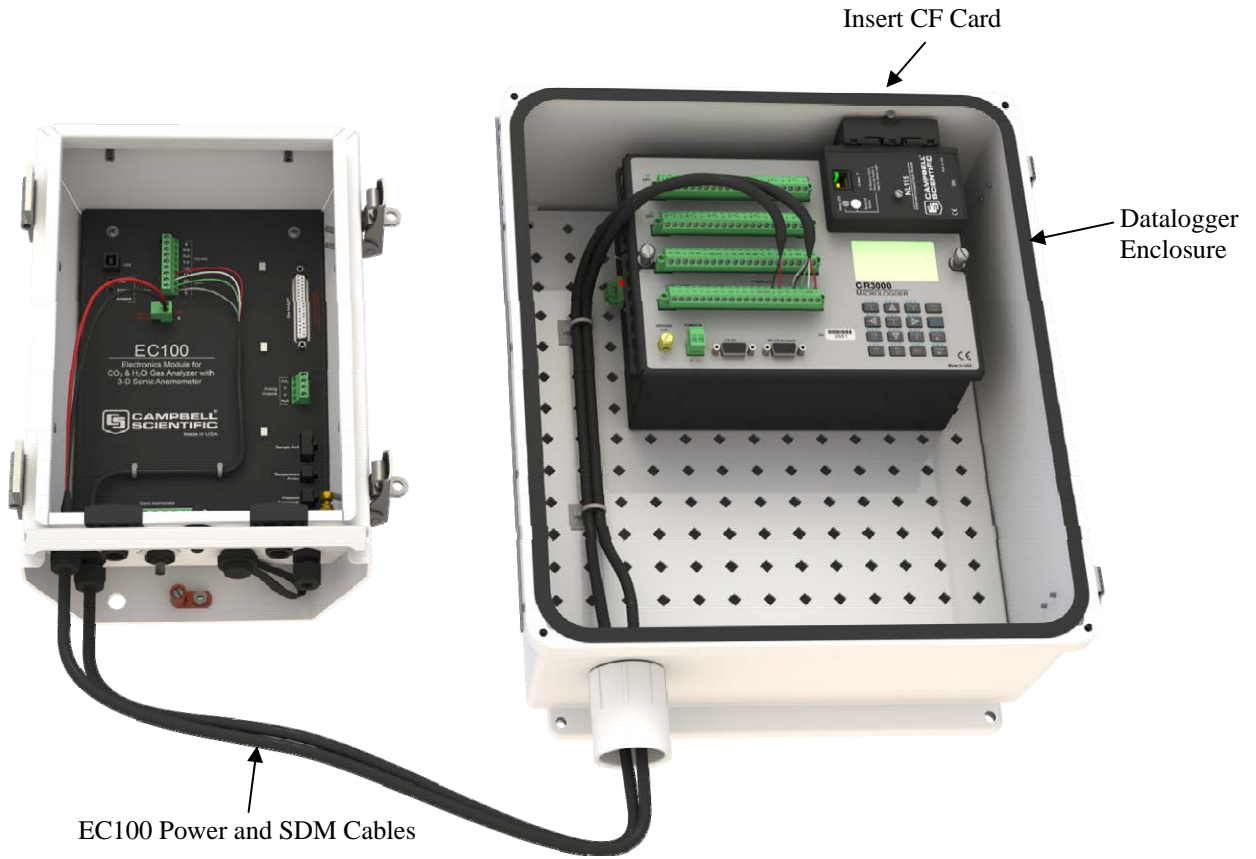

Power Cable (can connect here or directly to +12Vdc power supply)

SDM Cable

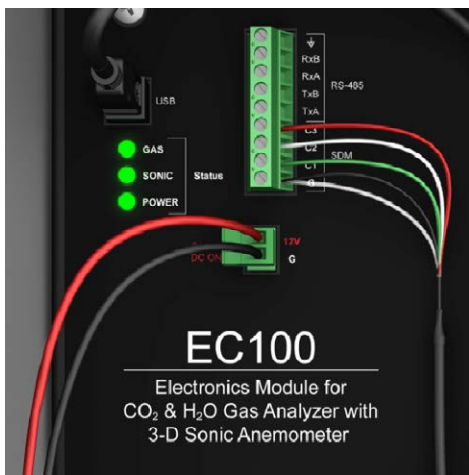

Power Cable

SDM Cable

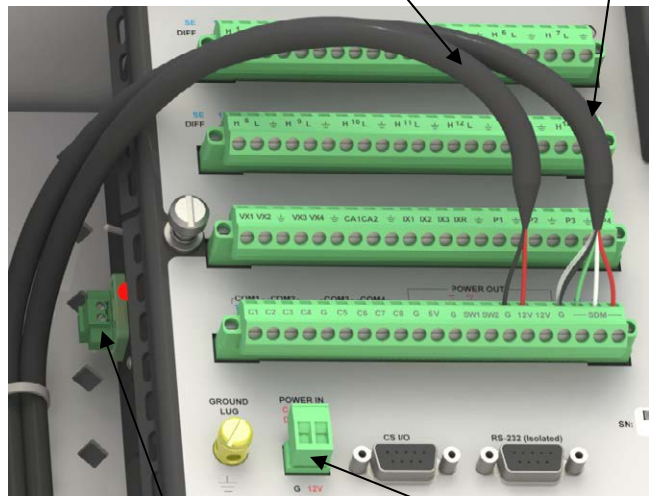

If datalogger has rechargeable base, connect cable from +17 to 28 Vdc or +18 Vac power supply here

Otherwise connect cable from +12Vdc power supply here

8. Turn on the power supply and use the datalogger keyboard display to set settings. (Follow the steps from left to right, top to bottom).

Press <Esc> to activate the display.
 Press <Enter> to display the System Control Menu.

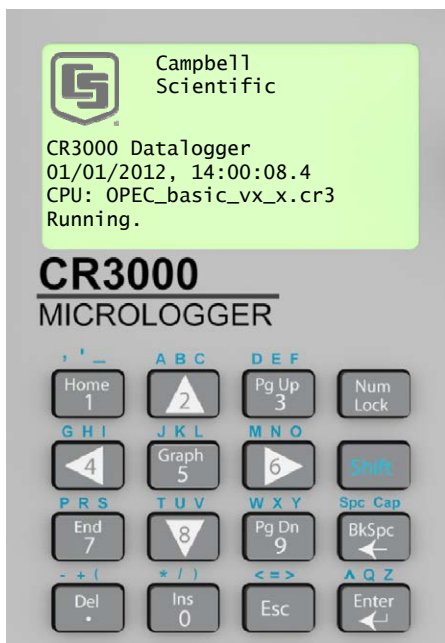

Select "Sonic Azmth".

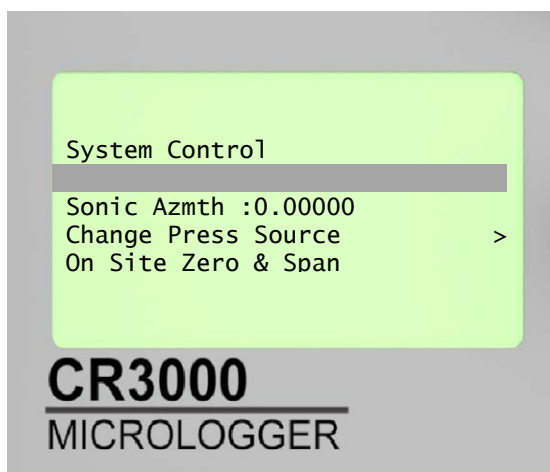

Enter in the azimuth (the angle in degrees between true north and the direction the IRGASON points), and press <ENTER>.

Press <Esc> to exit.

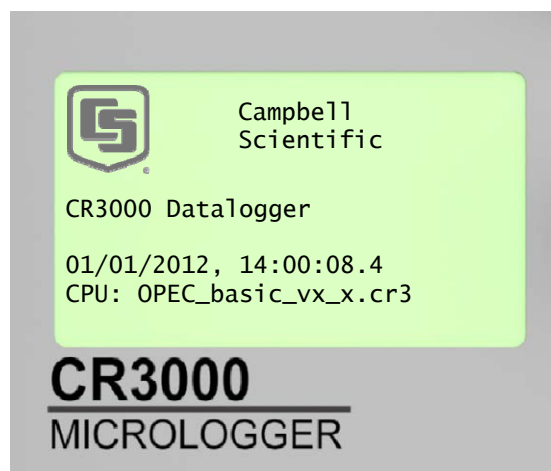
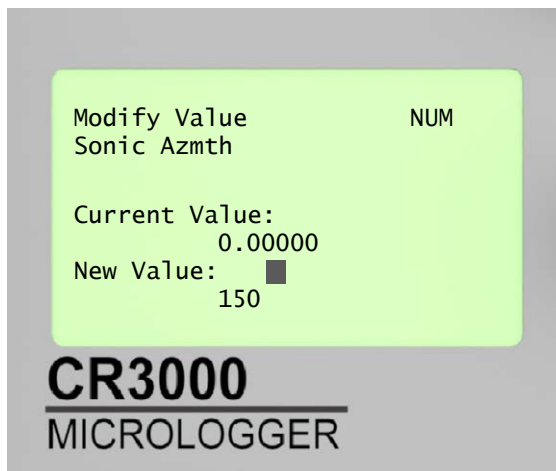

Campbell Scientific Companies

Campbell Scientific, Inc. (CSI)

815 West 1800 North
Logan, Utah 84321
UNITED STATES

www.campbellsci.com • info@campbellsci.com

Campbell Scientific Africa Pty. Ltd. (CSAf)

PO Box 2450
Somerset West 7129
SOUTH AFRICA

www.csafrica.co.za • cleroux@csafrica.co.za

Campbell Scientific Australia Pty. Ltd. (CSA)

PO Box 8108
Garbutt Post Shop QLD 4814
AUSTRALIA

www.campbellsci.com.au • info@campbellsci.com.au

Campbell Scientific do Brasil Ltda. (CSB)

Rua Apinagés, nbr. 2018 — Perdizes
CEP: 01258-00 — São Paulo — SP
BRASIL

www.campbellsci.com.br • vendas@campbellsci.com.br

Campbell Scientific Canada Corp. (CSC)

11564 - 149th Street NW
Edmonton, Alberta T5M 1W7
CANADA

www.campbellsci.ca • dataloggers@campbellsci.ca

Campbell Scientific Centro Caribe S.A. (CSCC)

300 N Cementerio, Edificio Breller
Santo Domingo, Heredia 40305
COSTA RICA

www.campbellsci.cc • info@campbellsci.cc

Campbell Scientific Ltd. (CSL)

Campbell Park
80 Hathern Road
Shepshed, Loughborough LE12 9GX
UNITED KINGDOM

www.campbellsci.co.uk • sales@campbellsci.co.uk

Campbell Scientific Ltd. (France)

3 Avenue de la Division Leclerc
92160 ANTONY
FRANCE

www.campbellsci.fr • info@campbellsci.fr

Campbell Scientific Spain, S. L.

Avda. Pompeu Fabra 7-9, local 1
08024 Barcelona
SPAIN

www.campbellsci.es • info@campbellsci.es

Please visit www.campbellsci.com to obtain contact information for your local US or international representative.