

INSTRUCTION MANUAL



LI190R Quantum Sensor

Revision: 4/16



Copyright © 1982-2016
Campbell Scientific, Inc.

Limited Warranty

“Products manufactured by CSI are warranted by CSI to be free from defects in materials and workmanship under normal use and service for twelve months from the date of shipment unless otherwise specified in the corresponding product manual. (Product manuals are available for review online at www.campbellsci.com.) Products not manufactured by CSI, but that are resold by CSI, are warranted only to the limits extended by the original manufacturer. Batteries, fine-wire thermocouples, desiccant, and other consumables have no warranty. CSI’s obligation under this warranty is limited to repairing or replacing (at CSI’s option) defective Products, which shall be the sole and exclusive remedy under this warranty. The Customer assumes all costs of removing, reinstalling, and shipping defective Products to CSI. CSI will return such Products by surface carrier prepaid within the continental United States of America. To all other locations, CSI will return such Products best way CIP (port of entry) per Incoterms ® 2010. This warranty shall not apply to any Products which have been subjected to modification, misuse, neglect, improper service, accidents of nature, or shipping damage. This warranty is in lieu of all other warranties, expressed or implied. The warranty for installation services performed by CSI such as programming to customer specifications, electrical connections to Products manufactured by CSI, and Product specific training, is part of CSI’s product warranty. **CSI EXPRESSLY DISCLAIMS AND EXCLUDES ANY IMPLIED WARRANTIES OF MERCHANTABILITY OR FITNESS FOR A PARTICULAR PURPOSE. CSI hereby disclaims, to the fullest extent allowed by applicable law, any and all warranties and conditions with respect to the Products, whether express, implied or statutory, other than those expressly provided herein.”**

Assistance

Products may not be returned without prior authorization. The following contact information is for US and international customers residing in countries served by Campbell Scientific, Inc. directly. Affiliate companies handle repairs for customers within their territories. Please visit www.campbellsci.com to determine which Campbell Scientific company serves your country.

To obtain a Returned Materials Authorization (RMA), contact CAMPBELL SCIENTIFIC, INC., phone (435) 227-9000. After an application engineer determines the nature of the problem, an RMA number will be issued. Please write this number clearly on the outside of the shipping container. Campbell Scientific's shipping address is:

CAMPBELL SCIENTIFIC, INC.

RMA# _____
815 West 1800 North
Logan, Utah 84321-1784

For all returns, the customer must fill out a "Statement of Product Cleanliness and Decontamination" form and comply with the requirements specified in it. The form is available from our website at www.campbellsci.com/repair. A completed form must be either emailed to repair@campbellsci.com or faxed to (435) 227-9106. Campbell Scientific is unable to process any returns until we receive this form. If the form is not received within three days of product receipt or is incomplete, the product will be returned to the customer at the customer's expense. Campbell Scientific reserves the right to refuse service on products that were exposed to contaminants that may cause health or safety concerns for our employees.

Safety

DANGER — MANY HAZARDS ARE ASSOCIATED WITH INSTALLING, USING, MAINTAINING, AND WORKING ON OR AROUND TRIPODS, TOWERS, AND ANY ATTACHMENTS TO TRIPODS AND TOWERS SUCH AS SENSORS, CROSSARMS, ENCLOSURES, ANTENNAS, ETC. FAILURE TO PROPERLY AND COMPLETELY ASSEMBLE, INSTALL, OPERATE, USE, AND MAINTAIN TRIPODS, TOWERS, AND ATTACHMENTS, AND FAILURE TO HEED WARNINGS, INCREASES THE RISK OF DEATH, ACCIDENT, SERIOUS INJURY, PROPERTY DAMAGE, AND PRODUCT FAILURE. TAKE ALL REASONABLE PRECAUTIONS TO AVOID THESE HAZARDS. CHECK WITH YOUR ORGANIZATION'S SAFETY COORDINATOR (OR POLICY) FOR PROCEDURES AND REQUIRED PROTECTIVE EQUIPMENT PRIOR TO PERFORMING ANY WORK.

Use tripods, towers, and attachments to tripods and towers only for purposes for which they are designed. Do not exceed design limits. Be familiar and comply with all instructions provided in product manuals. Manuals are available at www.campbellsci.com or by telephoning (435) 227-9000 (USA). You are responsible for conformance with governing codes and regulations, including safety regulations, and the integrity and location of structures or land to which towers, tripods, and any attachments are attached. Installation sites should be evaluated and approved by a qualified engineer. If questions or concerns arise regarding installation, use, or maintenance of tripods, towers, attachments, or electrical connections, consult with a licensed and qualified engineer or electrician.

General

- Prior to performing site or installation work, obtain required approvals and permits. Comply with all governing structure-height regulations, such as those of the FAA in the USA.
- Use only qualified personnel for installation, use, and maintenance of tripods and towers, and any attachments to tripods and towers. The use of licensed and qualified contractors is highly recommended.
- Read all applicable instructions carefully and understand procedures thoroughly before beginning work.
- Wear a **hardhat** and **eye protection**, and take **other appropriate safety precautions** while working on or around tripods and towers.
- **Do not climb** tripods or towers at any time, and prohibit climbing by other persons. Take reasonable precautions to secure tripod and tower sites from trespassers.
- Use only manufacturer recommended parts, materials, and tools.

Utility and Electrical

- **You can be killed** or sustain serious bodily injury if the tripod, tower, or attachments you are installing, constructing, using, or maintaining, or a tool, stake, or anchor, come in **contact with overhead or underground utility lines**.
- Maintain a distance of at least one-and-one-half times structure height, 20 feet, or the distance required by applicable law, **whichever is greater**, between overhead utility lines and the structure (tripod, tower, attachments, or tools).
- Prior to performing site or installation work, inform all utility companies and have all underground utilities marked.
- Comply with all electrical codes. Electrical equipment and related grounding devices should be installed by a licensed and qualified electrician.

Elevated Work and Weather

- Exercise extreme caution when performing elevated work.
- Use appropriate equipment and safety practices.
- During installation and maintenance, keep tower and tripod sites clear of un-trained or non-essential personnel. Take precautions to prevent elevated tools and objects from dropping.
- Do not perform any work in inclement weather, including wind, rain, snow, lightning, etc.

Maintenance

- Periodically (at least yearly) check for wear and damage, including corrosion, stress cracks, frayed cables, loose cable clamps, cable tightness, etc. and take necessary corrective actions.
- Periodically (at least yearly) check electrical ground connections.

WHILE EVERY ATTEMPT IS MADE TO EMBODY THE HIGHEST DEGREE OF SAFETY IN ALL CAMPBELL SCIENTIFIC PRODUCTS, THE CUSTOMER ASSUMES ALL RISK FROM ANY INJURY RESULTING FROM IMPROPER INSTALLATION, USE, OR MAINTENANCE OF TRIPODS, TOWERS, OR ATTACHMENTS TO TRIPODS AND TOWERS SUCH AS SENSORS, CROSSARMS, ENCLOSURES, ANTENNAS, ETC.

Table of Contents

PDF viewers: These page numbers refer to the printed version of this document. Use the PDF reader bookmarks tab for links to specific sections.

| | |
|---|------------|
| 1. Introduction | 1 |
| 2. Precautions | 1 |
| 3. Initial Inspection..... | 1 |
| 3.1 Ships With..... | 2 |
| 4. QuickStart..... | 2 |
| 5. Overview | 4 |
| 6. Specifications..... | 5 |
| 7. Installation | 6 |
| 7.1 Mount to a Tripod or Tower..... | 6 |
| 7.1.1 Tools Required..... | 6 |
| 7.1.2 Mounting Procedure..... | 7 |
| 7.1.2.1 CM225 Solar Sensor Mounting Stand..... | 7 |
| 7.1.2.2 015ARM..... | 9 |
| 7.2 Wiring | 10 |
| 7.3 Programming..... | 12 |
| 7.3.1 Input Range..... | 12 |
| 7.3.2 Multiplier | 13 |
| 7.4 Output Format Considerations | 13 |
| 8. Troubleshooting, Maintenance, and Calibration.... | 13 |
| 8.1 Troubleshooting | 14 |
| 8.2 Maintenance | 14 |
| 8.3 Calibration..... | 14 |
| 8.3.1 Taking the Sensor Apart | 15 |
| 8.3.1.1 Remove the Sensor..... | 15 |
| 8.3.1.2 If Using a Cover | 16 |
| 8.3.1.3 Putting On a Calibrated Sensor Head..... | 16 |
| 9. Acknowledgements | 17 |
| Appendices | |
| A. Importing Short Cut Code Into CRBasic Editor ... | A-1 |
| B. Example Programs..... | B-1 |
| B.1 Example CR1000 Program | B-1 |

B.2 Example CR6 Program..... B-2

Figures

5-1. LI190R spectral response 5
7-1. LI190R schematic 11

Tables

7-1. Datalogger Connections for Differential Measurements 11
7-2. Datalogger Connections for Single-Ended Measurements 11
7-3. Multiplier Required for Flux Density and Total Fluxes 13
8-1. Replacement Parts 15
B-1. Wiring for Example Programs..... B-1

CRBasic Examples

B-1. CR1000 Program..... B-1
B-2. CR6 Program..... B-2

LI190R Quantum Sensor

1. Introduction

The LI190R accurately measures Photosynthetic Photon Flux Density (PPFD) in both natural and artificial light. PPFD is the number of photons in the 400 to 700 nm waveband incident per unit time on a unit surface. Because PPFD describes photosynthetic activity, the LI190R is ideal for growth chambers and greenhouses.

NOTE

This manual provides information only for CRBasic dataloggers. It is also compatible with most of our retired Edlog dataloggers. For Edlog datalogger support, see an older LI190SB manual at www.campbellsci.com/old-manuals or contact a Campbell Scientific application engineer for assistance.

2. Precautions

- READ AND UNDERSTAND the *Safety* section at the front of this manual.
- Care should be taken when opening the shipping package to not damage or cut the cable jacket. If damage to the cable is suspected, consult with a Campbell Scientific application engineer.
- Although the LI190R is rugged, it should be handled as a precision scientific instrument.
- Keep the sensor clean. The vertical edge of the diffuser must be kept clean to maintain appropriate cosine correction.
- Clean the sensor only with water, mild detergent, or vinegar. Alcohol, organic solvents, abrasives, or strong detergents harm the acrylic materials, which will adversely affect the cosine response of the sensor.
- The black outer jacket of the cable is Santoprene® rubber. This compound was chosen for its resistance to temperature extremes, moisture, and UV degradation. However, this jacket will support combustion in air. It is rated as slow burning when tested according to U.L. 94 H.B. and will pass FMVSS302. Local fire codes may preclude its use inside buildings.

3. Initial Inspection

- Upon receipt of the LI190R, inspect the packaging and contents for damage. File damage claims with the shipping company.
- The model number and cable length are printed on a label at the connection end of the cable. Check this information against the shipping documents to ensure the correct product and cable length are received.

3.1 Ships With

- (1) *ResourceDVD* or Instruction Manual
- (1) Calibration Sheet

NOTE

The calibration sheet shipped with each sensor includes a serial number and calibration constant. The calibration constant is unique for each sensor, and is used to compute the multiplier for the measurement instruction in the datalogger program.

4. QuickStart

Short Cut is an easy way to program your datalogger to measure the LI190R and assign datalogger wiring terminals. *Short Cut* is available as a download on www.campbellsci.com and the *ResourceDVD*. It is included in installations of *LoggerNet*, *PC200W*, *PC400*, or *RTDAQ*.

The following procedure shows using *Short Cut* to program the LI190R.

1. Open *Short Cut*. Click **New Program**.

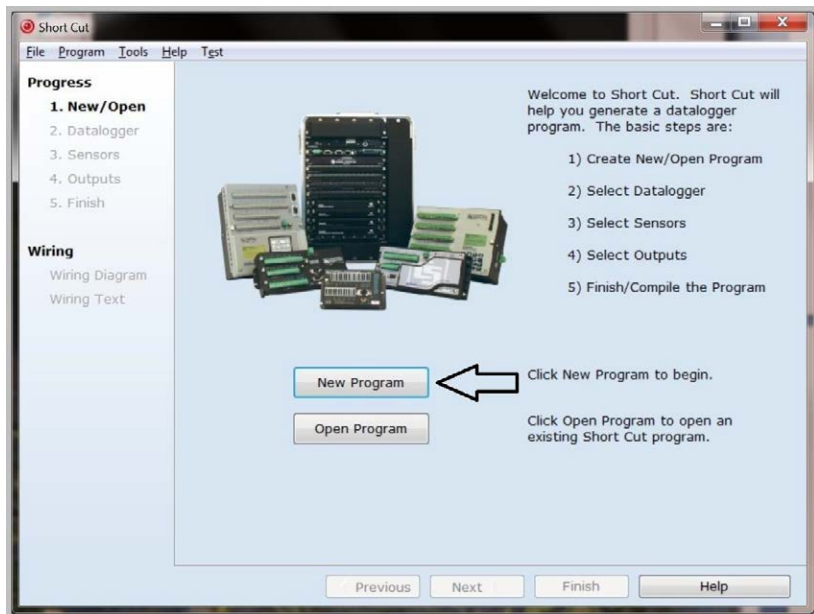

2. Select **Datalogger Model** and **Scan Interval** (default of 5 seconds is OK for most applications). Click **Next**.

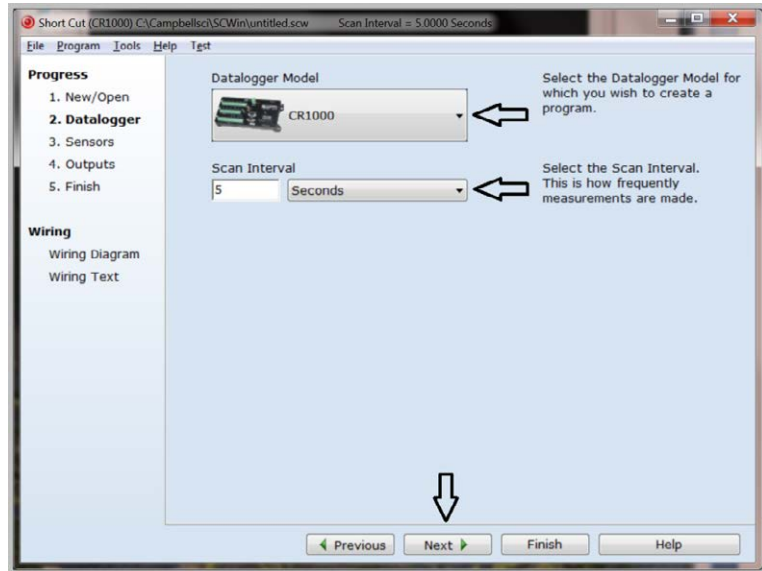

3. Under the **Available Sensors and Devices** list, select the **Sensors | Meteorological | Solar Radiation** folder. Select **LI190R Quantum Sensor**. Click  to move the selection to the **Selected** device window. Enter the **LI190R Output** that is provided on the calibration sheet shipped with the sensor. This value is unique to the individual sensor. The PAR flux density defaults to $\mu\text{mol m}^{-2}$ and the PAR total flux defaults to mmol m^{-2} . This can be changed by clicking the **PAR Flux Density** or **PAR Total Flux** box and selecting one of the other options.

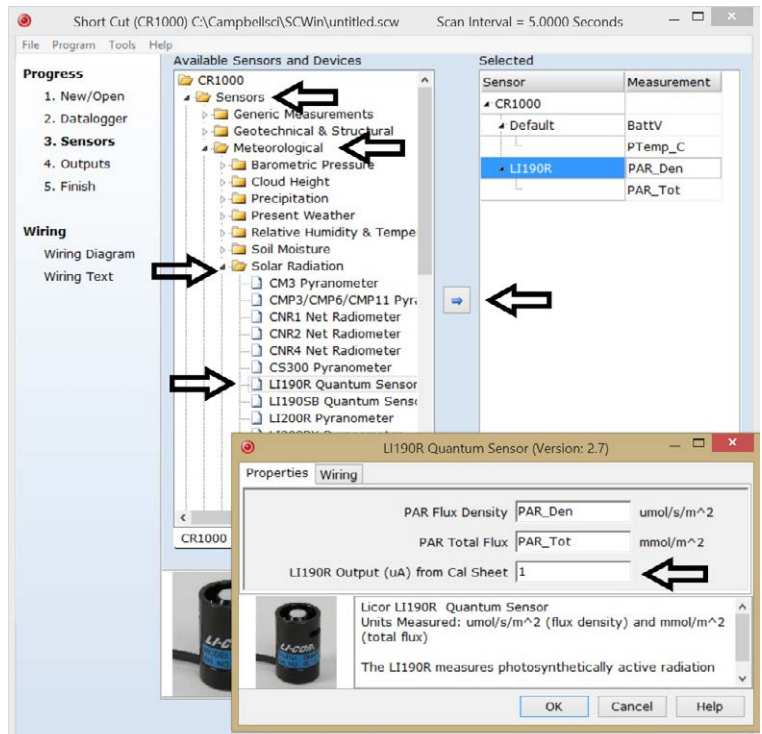

- After selecting the sensor, click **Wiring Diagram** to see how the sensor is to be wired to the datalogger. The wiring diagram can be printed now or after more sensors are added.

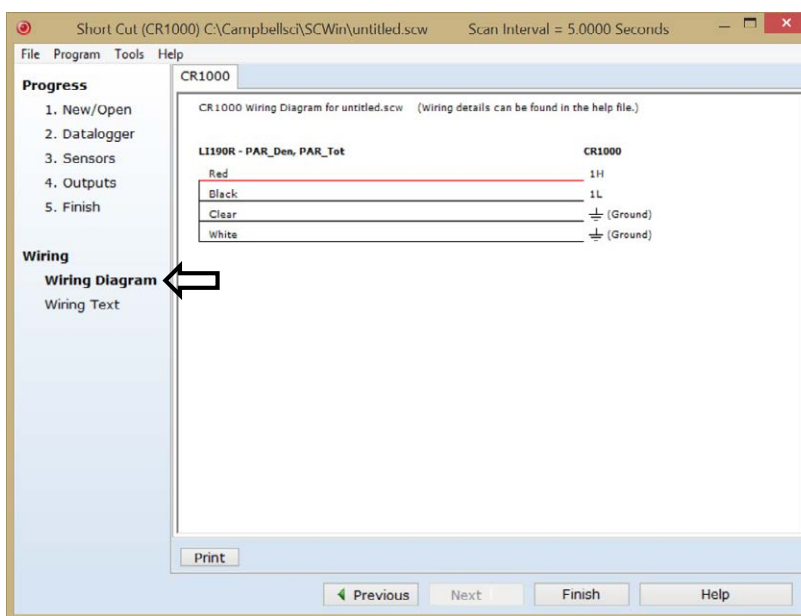

- Select any other sensors you have, then finish the remaining *Short Cut* steps to complete the program. The remaining steps are outlined in *Short Cut Help*, which is accessed by clicking on **Help | Contents | Programming Steps**.
- If *LoggerNet*, *PC400*, *RTDAQ*, or *PC200W* is running on your PC, and the PC to datalogger connection is active, you can click **Finish** in *Short Cut* and you will be prompted to send the program just created to the datalogger.
- If the sensor is connected to the datalogger, as shown in the wiring diagram in step 4, check the output of the sensor in the datalogger support software data display to make sure it is making reasonable measurements.

5. Overview

The LI190R quantum sensor measures photosynthetically active radiation (PAR) in the 400 to 700 nm waveband. The unit of measurement is micromoles per second per square meter ($\mu\text{mol s}^{-1}\text{m}^{-2}$).

The quantum sensor is designed to measure PAR received on a plane surface. The indicated sensor response (FIGURE 5-1) is selected because it approximates the photosynthetic response of plants for which data are available. A silicon photodiode with an enhanced response in the visible wavelengths is used as the sensor. A visible band pass interference filter in combination with colored glass filters is mounted in a cosine corrected head.

Measuring PAR within plant canopies, greenhouses, controlled environment chambers, confined laboratory conditions, or at remote environmental monitoring sites are all typical applications for this sensor.

During the night, the LI190R may output a slightly negative value, caused by RF noise. Negative values may be set to zero in the datalogger program.

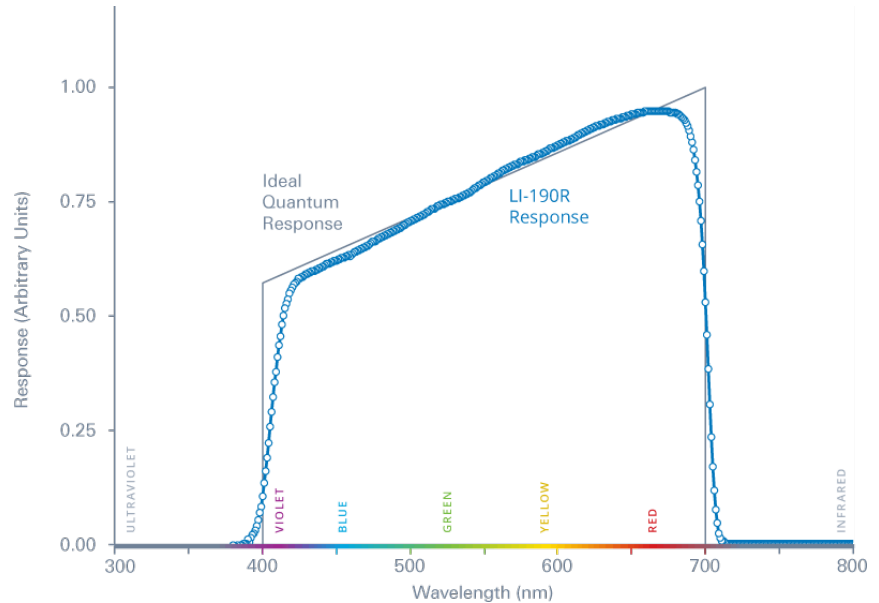

FIGURE 5-1. LI190R spectral response

The -L portion of the model number indicates that the LI190R has a user-specified cable length. Its cables can terminate in:

- Pigtails that connect directly to a Campbell Scientific datalogger.
- Connector that attaches to a prewired enclosure (cable termination option -PW).
- Connector that attaches to a CWS900-series interface (cable termination option -CWS). Connection to a CWS900-series interface allows this sensor to be used in a wireless sensor network.

6. Specifications

Features:

- Ideal for growth chambers and greenhouses
- Measures Photosynthetic Photon Flux Density (PPFD) in both natural and artificial light
- Compatible with Campbell Scientific CRBasic dataloggers: CR300 series, CR6 series, CR800 series, CR1000, CR3000, CR5000, and CR9000(X)

Stability: $\pm 2\%$ change over a 1 year period

Response Time: <math>< 1 \mu\text{s}</math>

Temperature Dependence: 0.15% per $^{\circ}\text{C}$ maximum

| | |
|---------------------------------|--|
| Cosine Correction: | Cosine corrected up to 82° angle of incidence |
| Operating Temperature: | –40 to 65 °C |
| Relative Humidity: | 0 to 100% |
| Detector: | High stability silicon photovoltaic detector (blue enhanced) |
| Sensor Housing: | Weatherproof anodized aluminum case with acrylic diffuser and stainless steel hardware; O-ring seal on the removable base and cable assembly |
| Diameter: | 2.36 cm (0.93 in) |
| Height: | 3.63 cm (1.43 in) |
| Weight: | 84 g (2.96 oz) |
| Calibration: | ±5% traceable to the U.S. National Institute of Standards Technology (NIST) |
| Sensitivity: | Typically 5 to 10 µA per 1000 µmol s ⁻¹ m ⁻² |
| Linearity: | Maximum deviation of 1% up to 10,000 µmol s ⁻¹ m ⁻² |
| Shunt Resistor: | 604 Ω, 0.1%, 25 PPM |
| Light Spectrum Waveband: | 400 to 700 nm |

7. Installation

If you are programming your datalogger with *Short Cut*, skip Section 7.2, *Wiring* (p.10), and Section 7.3, *Programming* (p.12). *Short Cut* does this work for you. See Section 4, *QuickStart* (p. 24), for a *Short Cut* tutorial.

7.1 Mount to a Tripod or Tower

7.1.1 Tools Required

Tools required for installation on a tripod or tower:

- Small and medium Phillips screwdrivers
- 1/2-inch open-end wrench
- Tape measure
- UV-resistant wire ties
- Side-cut pliers
- Compass
- Step ladder

7.1.2 Mounting Procedure

7.1.2.1 CM225 Solar Sensor Mounting Stand

CAUTION

The CM225 should never be mounted directly to a vertical pipe. Instead the CM225 should be mounted to a crossarm. This avoids reflections from the vertical pipe onto the sensor.

1. Mount the crossarm to the tripod or tower.
2. Place the CM225's U-bolt in the bottom holes and secure the CM225 to the crossarm by tightening the U-bolt nuts.

Mounting Screws

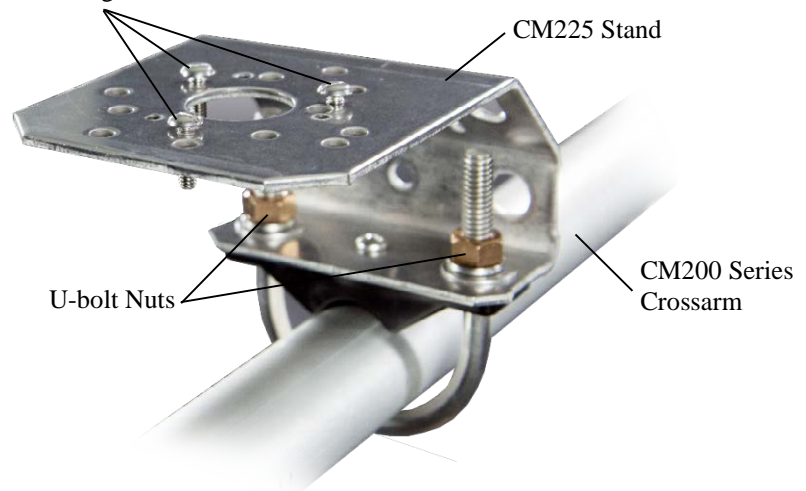

3. Place the LI190R in the center of the LI2003S base/leveling fixture and secure the LI190R to the LI2003S by tightening the small Phillips screws.

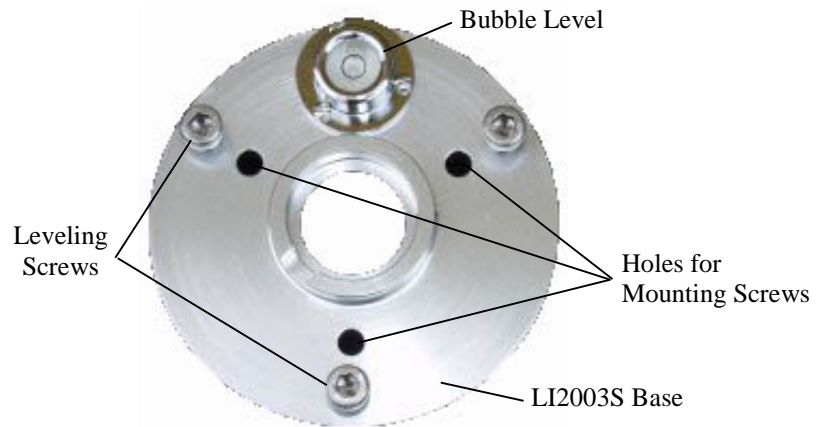



4. Loosely mount the LI2003S base/leveling fixture on the CM225. Do not fully tighten the three mounting screws.

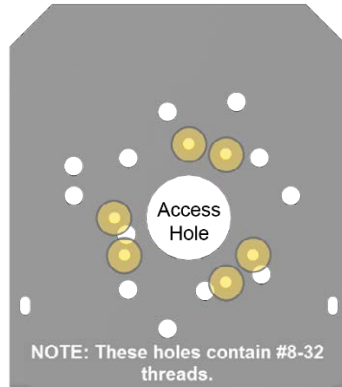

Threaded mounting holes used with the LI190R are indicated in yellow.

5. Turn the leveling screws as required to bring the bubble of the bubble level within the ring.

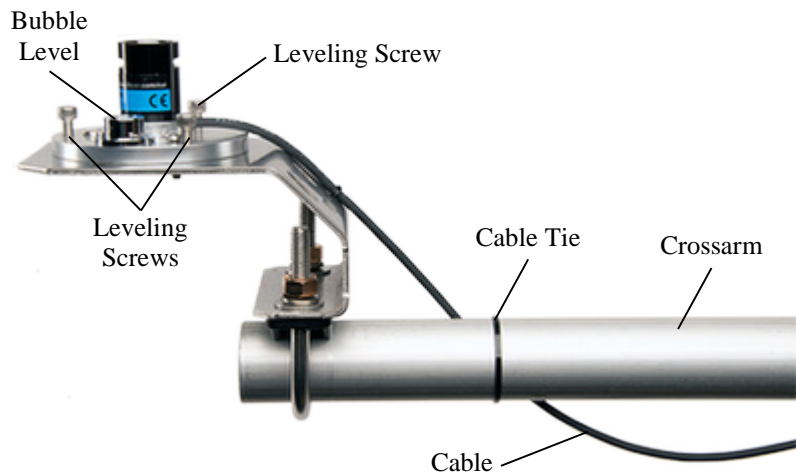

6. Tighten the mounting screws to secure the assembly in its final position. Check that the pyranometer is still correctly leveled and adjust as necessary.
7. Route the sensor cable along the underside of the crossarm to the tripod/tower, and to the instrument enclosure.
8. Secure the cable to the crossarm and mast using cable ties.
9. Remove the red cap after installing the sensor. Save this cap for shipping or storing the sensor.

7.1.2.2 015ARM

1. Secure the 015ARM to the mast by tightening the U-bolt nuts.

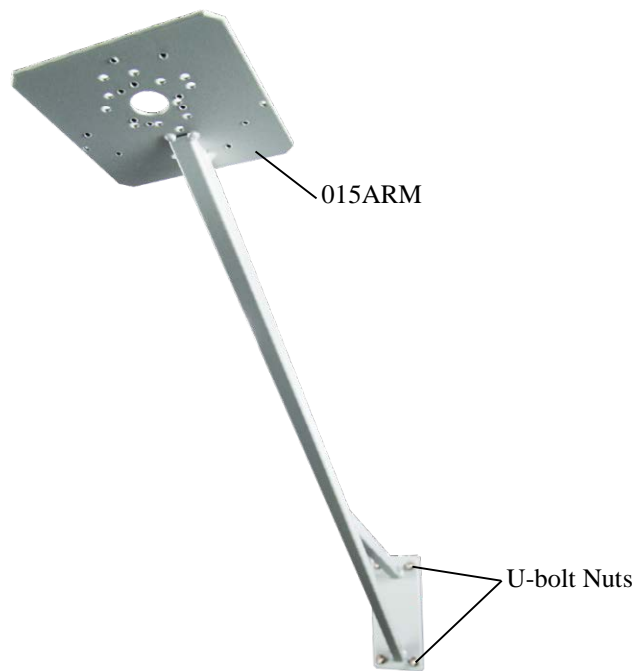

2. Place the LI190R in the center of the LI2003S base/leveling fixture and secure the LI190R to the LI2003S by tightening the small Phillips screws.

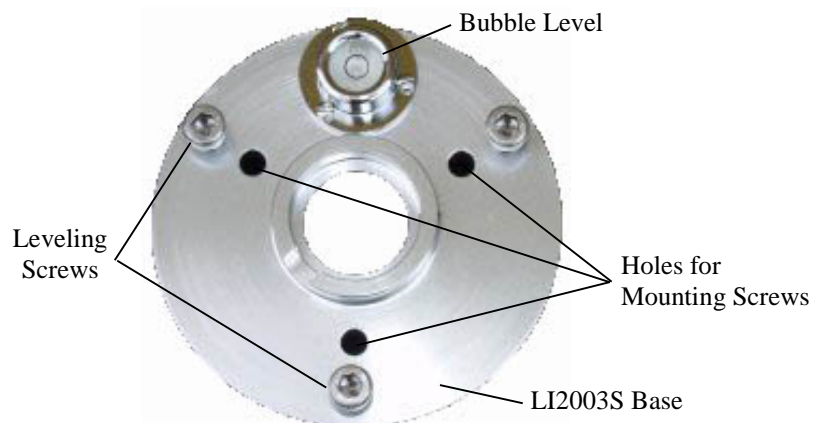

- Loosely mount the LI2003S base/leveling fixture on the 015ARM. Do not fully tighten the three mounting screws.

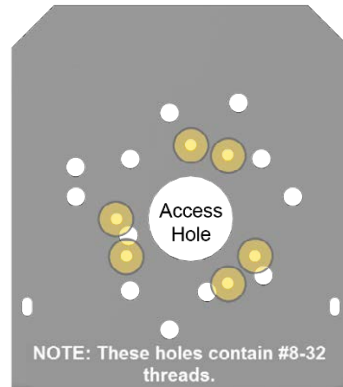

Threaded mounting holes used with the LI190R are indicated in yellow.

- Turn the leveling screws as required to bring the bubble of the bubble level within the ring.
- Tighten the mounting screws to secure the assembly in its final position. Check that the pyranometer is still correctly leveled and adjust as necessary.
- Route the sensor cable along the underside of the 015ARM's arm to the tripod/tower, and to the instrument enclosure.
- Secure the cable to the mounting arm and mast using cable ties.

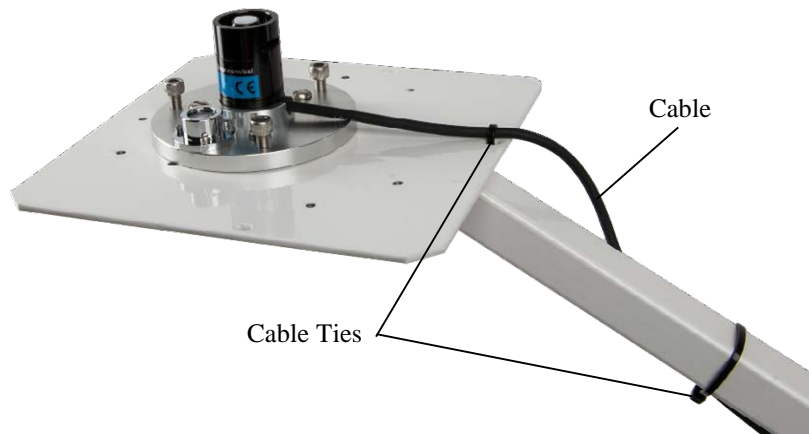

- Remove the red cap after installing the sensor. Save this cap for shipping or storing the sensor.

7.2 Wiring

A schematic diagram of the LI190R is shown in [FIGURE 7-1](#).

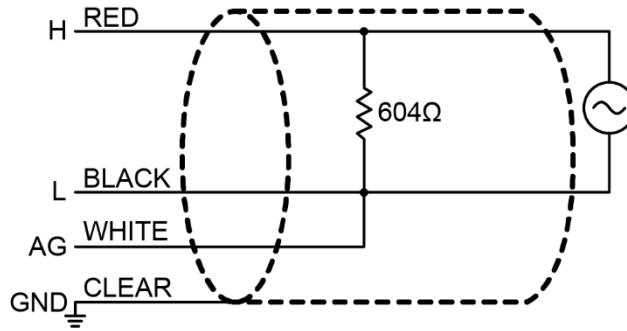

FIGURE 7-1. LI190R schematic

The LI190R is measured using either differential analog channels or single-ended analog channels. A differential voltage measurement is recommended because it has better noise rejection than a single-ended measurement.

Connections to Campbell Scientific dataloggers for a differential measurement are given in TABLE 7-1. Connections to Campbell Scientific dataloggers for a single-ended measurement are given in TABLE 7-2.

| TABLE 7-1. Datalogger Connections for Differential Measurements | | |
|---|------------------|---|
| Wire Color | Wire Function | Datalogger Connection Terminal |
| Red | Signal | U configured for differential high input ¹ , DIFF H (differential high, analog-voltage input) |
| Black | Signal Reference | U configured for differential input low ¹ , DIFF L (differential low, analog-voltage input) |
| White | Analog Ground | AG or \perp (analog ground) |
| Clear | Shield | AG or \perp (analog ground) |

¹U channels are automatically configured by the measurement instruction.

| TABLE 7-2. Datalogger Connections for Single-Ended Measurements | | |
|---|------------------|--|
| Wire Color | Wire Function | Datalogger Connection Terminal |
| Red | Signal | U configured for single-ended analog input ¹ , SE (single-ended, analog-voltage input) |
| Black | Signal Reference | AG or \perp (analog ground) |
| White | Analog Ground | AG or \perp (analog ground) |
| Clear | Shield | AG or \perp (analog ground) |

¹U channels are automatically configured by the measurement instruction.

7.3 Programming

Short Cut is the best source for up-to-date datalogger programming code. Programming code is needed when:

- Creating a program for a new datalogger installation
- Adding sensors to an existing datalogger program

If your data acquisition requirements are simple, you can probably create and maintain a datalogger program exclusively with *Short Cut*. If your data acquisition needs are more complex, the files that *Short Cut* creates are a great source for programming code to start a new program or add to an existing custom program.

NOTE

Short Cut cannot edit programs after they are imported and edited in *CRBasic Editor*.

A *Short Cut* tutorial is available in Section 4, *QuickStart* (p. 2). If you wish to import *Short Cut* code into *CRBasic Editor* to create or add to a customized program, follow the procedure in Appendix A, *Importing Short Cut Code Into CRBasic Editor* (p. A-1). Programming basics for CRBasic dataloggers are provided in the following sections. Complete program examples for CRBasic dataloggers can be found in Appendix B, *Example Programs* (p. B-1). Programming basics and programming examples for Edlog dataloggers are provided at www.campbellsci.com/old-manuals.

Output from the LI190R is a voltage ranging from 0 to a maximum of 10 mV depending on sensor calibration and radiation level, which is measured by the datalogger using a differential analog input channel. To measure the output, CRBasic dataloggers are programmed with the **VoltDiff()** instruction.

Nearby ac power lines, electric pumps, or motors can be a source of electrical noise. If the sensor or datalogger is located in an electrically noisy environment, the measurement should be made with the 60 or 50 Hz rejection integration option as shown in the example programs.

Solar radiation can be reported as an average flux density ($\mu\text{mol s}^{-1}\text{m}^{-2}$) or daily total flux density (mmol m^{-2}). The appropriate multipliers are listed in TABLE 7-3.

If a differential channel is not available, a single-ended measurement is a possibility; the **VoltSE()** instruction is used to make single-ended measurements. As a test, wire (TABLE 7-2) and program the LI190R to make a single-ended measurement and then wire (TABLE 7-1) and program the LI190R to make a differential measurement. Compare the results to determine the acceptability of a single-ended measurement.

7.3.1 Input Range

An example showing how to determine the optimum input range for a given sensor calibration and maximum PAR is given below. This is an example only. Your values will be different.

- Sensor Calibration: Assume the sensor calibration is $8 \mu\text{A}/1000 \mu\text{mol s}^{-1}\text{m}^{-2}$ ($1000 \mu\text{mol} = 1 \text{mmol}$). The LI190R outputs amperage

which is converted to voltage by a 604 ohm shunt resistor in the cable. To convert the calibration from microamps to millivolts, multiply the calibration by 0.604. The example calibration changes to 4.83 mV/mmol s⁻¹m⁻².

- **Maximum PAR:** A reasonable estimate of maximum PAR is 2 mmol s⁻¹m⁻².
- **Input Range Selection:** An estimate of the maximum input voltage is obtained by multiplying the calibration by the maximum expected PAR. That product is 9.66 mV for this example. Select the smallest input range which is greater than the maximum expected input voltage

Measurement integration time is specified in the input range parameter code. A more noise-free reading is obtained with the slow or 60 Hz rejection integration. A fast integration takes less power and allows for faster throughput.

7.3.2 Multiplier

The multiplier converts the millivolt reading to engineering units. Commonly used units and how to calculate the multiplier are shown in TABLE 7-3.

| TABLE 7-3. Multiplier Required for Flux Density and Total Fluxes | |
|---|--------------------------------|
| Units | Multiplier |
| $\mu\text{mol s}^{-1} \text{m}^{-2}$ | 1000/C (flux density) |
| mmol m^{-2} | $(1/C) \cdot t$ (total fluxes) |
| C = (LI-COR® calibration) • 0.604 t = datalogger program execution interval in seconds | |
| Unit Conversions $\mu\text{E}/\mu\text{mol}$ $(6.02 \times 10^{17} \text{ photons s}^{-1} \text{m}^{-2})/(\mu\text{mol s}^{-1} \text{m}^{-2})$ | |

7.4 Output Format Considerations

If solar radiation is totalized in units of mmol m⁻², there is a possibility of overranging the output limits. For CRBasic dataloggers, you can avoid this by using the IEEE4 or long data format.

The disadvantage of the high resolution formats is that it takes more memory per data point.

8. Troubleshooting, Maintenance, and Calibration

NOTE

All factory repairs and recalibrations require a returned material authorization (RMA) and completion of the “Declaration of Hazardous Material and Decontamination” form. Refer to the [Assistance](#) page at the beginning of this document for more information.

8.1 Troubleshooting

Symptom: -9999 or radiation values around 0

1. Check that the sensor is wired to the differential channel specified by the measurement instruction.
2. Verify that the range code is correct for the datalogger type.
3. Disconnect the sensor leads from the datalogger and use a DVM to check the voltage between the red (+) and the black (-) wires. You should see a voltage of 0 to 10 mV for 0 to 1000 Wm^{-2} radiation. No voltage indicates a problem with the photodiode, the cable, or the variable shunt resistor.

Symptom: Incorrect solar radiation

1. Make sure the top surface of the sensor head is clean and that the sensor is properly leveled.
2. Verify that the range, multiplier, and offset parameters are correct for the desired engineering units and datalogger type.

8.2 Maintenance

Keep the sensor clean and treat it as a scientific instrument to maintain the accuracy of the calibration. The vertical edge of the diffuser must be kept clean to maintain appropriate cosine correction.

Clean the sensor only with water and/or a mild detergent such as dishwashing soap. Vinegar can also be used to remove hard water deposits from the diffuser element if necessary.

CAUTION

Do not use alcohol, organic solvents, abrasives, or strong detergents to clean the diffuser element. Exposure to alcohol or organic solvents harm the acrylic materials of the sensor, which will adversely affect the cosine response of the sensor.

8.3 Calibration

Recalibrate the LI190R every two years.

The LI190R is designed so that the sensor can be separated into two parts — the sensor head containing the photodiode can be disconnected from the base and cabling. Calibration values follow the sensor head. Each sensor head has a unique calibration value. When the sensor is cabled at the factory, the sensor calibration value, as received from LI-COR®, is put on a heat shrink label close to the end of the cable. We recommend sending the entire sensor and cable to Campbell Scientific for recalibration. Along with a calibration certificate, a new heat shrink label will be put on the cable with the new calibration value.

In instances where it's problematic to send in the entire sensor and cable, you can send only the sensor head for recalibration. A new calibrated LI190R head can be used with the base or a protective cover put over it. Never leave the base

part of the sensor exposed to the environment while the sensor head is being calibrated.

NOTE The cable will no longer have the correct calibration information on the label when calibration is done in this manner.

The datalogger program will need to be updated with the new calibration value regardless of which method is used.

8.3.1 Taking the Sensor Apart

Replace the O-ring gasket on the base each time a sensor head is sent in for calibration. You will need the parts listed in TABLE 8-1; call for pricing.

| Part Number | Description | Notes |
|--------------------|--|---|
| 31976 | LI-COR® Replacement LI190R and LI200R O-ring | Replace this O-ring every time a sensor is separated. |
| *31977 | LI-COR® LI190R and LI200R Sensor Base Cover | Cover comes with three small Phillips screws. Cap and screws can be reused. |
| *32217 | LI-COR® LI190R Replacement Head | |

*Use one or the other; do not need both of them.

Tools needed:

- Small Phillips screwdriver
- Small slotted screwdriver

NOTE Collect all data from the datalogger before working on any sensors. Power the datalogger down while removing the sensor. Power can be applied to the datalogger after work is completed. The datalogger program can be run without a sensor attached, but the values will be erroneous. Write down the time and date that the station was worked on to keep track of when bad data occurs in the data file for these readings and when a calibrated sensor is put back in place.

8.3.1.1 Remove the Sensor

1. Remove the sensor from the leveling fixture.
2. Remove the three small Phillips screws from the underside of the sensor. Don't lose them.
3. Gently pull the sensor apart. Notice the two wires coming up from the base into a small printed circuit board. This printed circuit board has two gold-plated sockets that mate with two gold-plated pins from the sensor head.

4. With a small screwdriver, gently pry the printed circuit board away from the pins. Do not twist the wires any more than absolutely necessary. The figure below shows a separated LI200R sensor. The LI190R will look the same when disassembled.



5. Put the sensor head in a safe place.

8.3.1.2 If Using a Cover

1. Place the sensor cover (pn 31977) over the base and screw it into place using the three Phillips screws. Screw it down tight, but be careful not to strip the screw heads.
2. Secure the base and cover to the LI2003S leveling fixture.



8.3.1.3 Putting On a Calibrated Sensor Head

1. If using a cover:
 - a. Remove the base and cover from the LI2003S leveling fixture.
 - b. Turn the base over and remove the three small Phillips screws holding the cover in place. Don't lose the screws.
 - c. Remove the protective cover. Put the cover in a safe place.
2. Replace the O-ring (pn 31976) on the base with a new one. You might need to use a small slotted screwdriver to gently pry off the old O-ring.
3. The printed circuit board will only fit inside the sensor head one way. Line up the sensor head pins with the printed circuit board sockets and gently push them together. You might need to use a small slotted screwdriver to make sure the printed circuit board is completely seated into the mating sensor head.

4. Seat the sensor head on to the base and use the three small Phillips screws to secure the assembly. Screw it down tight, but be careful not to strip the screw heads.
5. Remember to update the datalogger program with the new sensor head calibration value.
6. Pack the head to be calibrated for shipment and send it to Campbell Scientific. Refer to the [Assistance](#) page at the beginning of this document for the required procedure for sending equipment to Campbell Scientific.

9. Acknowledgements

Campbell Scientific, Inc. gratefully acknowledges the contribution of LI-COR® to concepts, text, and images used in this manual.

Appendix A. Importing Short Cut Code Into CRBasic Editor

This tutorial shows:

- How to import a *Short Cut* program into a program editor for additional refinement
- How to import a wiring diagram from *Short Cut* into the comments of a custom program

Short Cut creates files, which can be imported into *CRBasic Editor*. Assuming defaults were used when *Short Cut* was installed, these files reside in the C:\campbellsci\SCWin folder:

- .DEF (wiring and memory usage information)
- .CR300 (CR300-series datalogger code)
- .CR6 (CR6-series datalogger code)
- .CR8 (CR800-series datalogger code)
- .CR1 (CR1000 datalogger code)
- .CR3 (CR3000 datalogger code)
- .CR5 (CR5000 datalogger code)
- .CR9 (CR9000(X) datalogger code)

Use the following procedure to import *Short Cut* code and wiring diagram into *CRBasic Editor*.

1. Create the *Short Cut* program following the procedure in Section 4, *QuickStart* (p. 2). Finish the program and exit *Short Cut*. Make note of the file name used when saving the *Short Cut* program.
2. Open *CRBasic Editor*.
3. Click **File** | **Open**. Assuming the default paths were used when *Short Cut* was installed, navigate to C:\CampbellSci\SCWin folder. The file of interest has the .CR300, .CR6, .CR8, .CR1, .CR3, .CR5, or .CR9 extension. Select the file and click **Open**.
4. Immediately save the file in a folder different from C:\Campbellsci\SCWin, or save the file with a different file name.

NOTE

Once the file is edited with *CRBasic Editor*, *Short Cut* can no longer be used to edit the datalogger program. Change the name of the program file or move it, or *Short Cut* may overwrite it next time it is used.

5. The program can now be edited, saved, and sent to the datalogger.
6. Import wiring information to the program by opening the associated .DEF file. Copy and paste the section beginning with heading “-Wiring for CRXXX-” into the CRBasic program, usually at the head of the file. After pasting, edit the information such that an apostrophe (') begins each line. This character instructs the datalogger compiler to ignore the line when compiling.

Appendix B. Example Programs

The example programs measure the LI190R every 10 s, and converts the mV output to $\mu\text{mol s}^{-1}\text{m}^{-2}$ and mmol m^{-2} . It outputs an hourly average flux ($\mu\text{mol s}^{-1}\text{m}^{-2}$) and a daily total flux density (mmol m^{-2}).

Wiring for the example is given in TABLE B-1. The multipliers is based upon a sensor calibration constant of $6.45 \mu\text{A}/1000 \mu\text{mol s}^{-1}\text{m}^{-2}$.

TABLE B-1. Wiring for Example Programs

| Color | Description | CR1000 | CR6 |
|-------|------------------|--------|-----|
| Red | Signal | 1H | U1 |
| Black | Signal Reference | 1L | U2 |
| White | Analog Ground | ⊥ | ⊥ |
| Clear | Shield | ⊥ | ⊥ |

B.1 Example CR1000 Program

CRBasic Example B-1. CR1000 Program

```
'CR1000

'Declare Variables and Units
Public PAR_Den
Public PAR_Tot

Units PAR_Den= $\mu\text{mol/s/m}^2$ 
Units PAR_Tot= $\text{mmol/m}^2$ 

'Define Data Tables
DataTable(Table1,True,-1)
  DataInterval(0,60,Min,10)
  Average(1,PAR_Den,FP2,False)
EndTable

DataTable(Table2,True,-1)
  DataInterval(0,1440,Min,10)
  Totalize(1,PAR_Tot,IEEE4,False)
EndTable

'Main Program
BeginProg
  Scan(10,Sec,1,0)
  'LI190R Quantum Sensor measurements PAR_Tot and PAR_Den:
  VoltDiff(PAR_Den,1,mV25,1,True,0,_60Hz,1,0) 'Use 20 mV range for CR3000, CR5000
  'Set negative values to zero
  If PAR_Den<0 Then PAR_Den=0
  PAR_Tot=PAR_Den*2.56686 'Multipliers will differ for each sensor and scan rate
  PAR_Den=PAR_Den*256.686
  'Call Data Tables and Store Data
  CallTable(Table1)
  CallTable(Table2)
NextScan
EndProg
```

B.2 Example CR6 Program

CRBasic Example B-2. CR6 Program

```

'CR6 Series

'Declare Variables and Units
Public BattV
Public PTemp_C
Public PAR_Den
Public PAR_Tot

Units BattV=Volts
Units PTemp_C=Deg C
Units PAR_Den=umol/s/m^2
Units PAR_Tot=mmol/m^2

'Define Data Tables
DataTable(Table1,True,-1)
  DataInterval(0,60,Min,10)
  Average(1,PAR_Den,FP2,False)
EndTable

DataTable(Table2,True,-1)
  DataInterval(0,1440,Min,10)
  Minimum(1,BattV,FP2,False,False)
  Totalize(1,PAR_Tot,IIEEE4,False)
EndTable

'Main Program
BeginProg
  'Main Scan
  Scan(10,Sec,1,0)
  'Default Datalogger Battery Voltage measurement 'BattV'
  Battery(BattV)

  'Default Wiring Panel Temperature measurement 'PTemp_C'
  PanelTemp(PTemp_C,60)

  'LI190R Quantum Sensor measurements 'PAR_Tot' and 'PAR_Den
  VoltDiff(PAR_Den,1,mV200,U1,True,0,60,1,0)
  If PAR_Den<0 Then PAR_Den=0
  PAR_Tot=PAR_Den*2.566867
  PAR_Den=PAR_Den*256.6867

  'Call Data Tables and Store Data
  CallTable Table1
  CallTable Table2
NextScan
EndProg

```

Campbell Scientific Companies

Campbell Scientific, Inc.

815 West 1800 North
Logan, Utah 84321
UNITED STATES

www.campbellsci.com • info@campbellsci.com

Campbell Scientific Canada Corp.

14532 – 131 Avenue NW
Edmonton AB T5L 4X4
CANADA

www.campbellsci.ca • dataloggers@campbellsci.ca

Campbell Scientific Africa Pty. Ltd.

PO Box 2450
Somerset West 7129
SOUTH AFRICA

www.campbellsci.co.za • cleroux@csafrica.co.za

Campbell Scientific Centro Caribe S.A.

300 N Cementerio, Edificio Breller
Santo Domingo, Heredia 40305
COSTA RICA

www.campbellsci.cc • info@campbellsci.cc

Campbell Scientific Southeast Asia Co., Ltd.

877/22 Nirvana@Work, Rama 9 Road
Suan Luang Subdistrict, Suan Luang District
Bangkok 10250
THAILAND

www.campbellsci.asia • info@campbellsci.asia

Campbell Scientific Ltd.

Campbell Park
80 Hathern Road
Shephed, Loughborough LE12 9GX
UNITED KINGDOM

www.campbellsci.co.uk • sales@campbellsci.co.uk

Campbell Scientific Australia Pty. Ltd.

PO Box 8108
Garbutt Post Shop QLD 4814
AUSTRALIA

www.campbellsci.com.au • info@campbellsci.com.au

Campbell Scientific Ltd.

3 Avenue de la Division Leclerc
92160 ANTONY
FRANCE

www.campbellsci.fr • info@campbellsci.fr

Campbell Scientific (Beijing) Co., Ltd.

8B16, Floor 8 Tower B, Hanwei Plaza
7 Guanghua Road
Chaoyang, Beijing 100004
P.R. CHINA

www.campbellsci.com • info@campbellsci.com.cn

Campbell Scientific Ltd.

Fahrenheitstraße 13
28359 Bremen
GERMANY

www.campbellsci.de • info@campbellsci.de

Campbell Scientific do Brasil Ltda.

Rua Apinagés, nbr. 2018 – Perdizes
CEP: 01258-00 – São Paulo – SP
BRASIL

www.campbellsci.com.br • vendas@campbellsci.com.br

Campbell Scientific Spain, S. L.

Avda. Pompeu Fabra 7-9, local 1
08024 Barcelona
SPAIN

www.campbellsci.es • info@campbellsci.es

Please visit www.campbellsci.com to obtain contact information for your local US or international representative.