

# INSTRUCTION MANUAL



## CS431 Submersible Pressure Transducer

Revision: 3/09



Copyright © 2008-2009  
Campbell Scientific, Inc.

# **Warranty and Assistance**

---

The **CS431 SUBMERSIBLE PRESSURE TRANSDUCER** is warranted by CAMPBELL SCIENTIFIC, INC. to be free from defects in materials and workmanship under normal use and service for twelve (12) months from date of shipment unless specified otherwise. Batteries have no warranty. CAMPBELL SCIENTIFIC, INC.'s obligation under this warranty is limited to repairing or replacing (at CAMPBELL SCIENTIFIC, INC.'s option) defective products. The customer shall assume all costs of removing, reinstalling, and shipping defective products to CAMPBELL SCIENTIFIC, INC. CAMPBELL SCIENTIFIC, INC. will return such products by surface carrier prepaid. This warranty shall not apply to any CAMPBELL SCIENTIFIC, INC. products which have been subjected to modification, misuse, neglect, accidents of nature, or shipping damage. This warranty is in lieu of all other warranties, expressed or implied, including warranties of merchantability or fitness for a particular purpose. CAMPBELL SCIENTIFIC, INC. is not liable for special, indirect, incidental, or consequential damages.

Products may not be returned without prior authorization. The following contact information is for US and International customers residing in countries served by Campbell Scientific, Inc. directly. Affiliate companies handle repairs for customers within their territories. Please visit [www.campbellsci.com](http://www.campbellsci.com) to determine which Campbell Scientific company serves your country.

To obtain a Returned Materials Authorization (RMA), contact CAMPBELL SCIENTIFIC, INC., phone (435) 753-2342. After an applications engineer determines the nature of the problem, an RMA number will be issued. Please write this number clearly on the outside of the shipping container. CAMPBELL SCIENTIFIC's shipping address is:

**CAMPBELL SCIENTIFIC, INC.**

RMA#\_\_\_\_\_

815 West 1800 North

Logan, Utah 84321-1784

For all returns, the customer must fill out a "Declaration of Hazardous Material and Decontamination" form and comply with the requirements specified in it. The form is available from our website at [www.campbellsci.com/repair](http://www.campbellsci.com/repair). A completed form must be either emailed to [shanna@campbellsci.com](mailto:shanna@campbellsci.com) or faxed to 435-750-9579. Campbell Scientific will not process any returns until we receive this form. If the form is not received within three days of product receipt or is incomplete, the product will be returned to the customer at the customer's expense. Campbell Scientific reserves the right to refuse service on products that were exposed to contaminants that may cause health or safety concerns for our employees.

CAMPBELL SCIENTIFIC, INC. does not accept collect calls.

# CS431 Table of Contents

---

*PDF viewers note: These page numbers refer to the printed version of this document. Use the Adobe Acrobat® bookmarks tab for links to specific sections.*

<b>1. General Description</b> .....	<b>1</b>
<b>2. Specifications</b> .....	<b>1</b>
<b>3. Installation</b> .....	<b>2</b>
3.1 Initial Inspection .....	2
3.2 Vent Tube .....	2
3.3 Water Depth.....	2
3.4 Well Installations .....	2
3.5 Other Installations.....	3
<b>4. Wiring</b> .....	<b>3</b>
4.1 Datalogger Connections.....	3
4.2 Grounding.....	4
<b>5. Datalogger Programming</b> .....	<b>4</b>
5.1 CRBasic Instructions .....	5
5.1.1 Example CRBasic Programs .....	6
5.1.1.1 Example CR1000 PROGRAM – STANDARD CALIBRATION.....	6
5.1.1.2 Example CR1000 PROGRAM – ENHANCED CALIBRATION.....	8
5.2 Edlog Instructions.....	9
5.2.1 Example Edlog Programs.....	10
5.2.1.1 Example CR10X PROGRAM – STANDARD .....	10
5.2.1.2 Example CR10X PROGRAM – Enhanced Measurement ..	11
5.2.1.3 Example CR10X PROGRAM – High Precision Measurement for 5 PSI Sensors .....	12
<b>6. Maintenance</b> .....	<b>13</b>
<b>7. Troubleshooting</b> .....	<b>14</b>
7.1 Erratic Readings .....	14
7.2 Oscillating Readings Over Time.....	14
7.3 Zero Readings When Pressurized.....	14
7.4 Grounding Issues .....	14

**Figures**

4.1. Typical Pressure Element Wiring ..... 3  
4-2. Typical Temperature Element Wiring ..... 4  
6-1. Desiccant Tube ..... 13

**Tables**

5-1. CR1000 Connections for Example Programs ..... 6

# CS431 Submersible Pressure Transducer

---

## 1. General Description

The CS431 PS9805 Pressure Transducer is manufactured by Instrumentation Northwest for use with Campbell Scientific dataloggers. It uses piezoresistive strain gage technology to measure water level and an on-board thermistor to measure temperature. Piezoresistive transducers include a strain gage bonded to a pressure-sensitive diaphragm. Electrical resistance changes as pressure changes on the diaphragm. Campbell Scientific dataloggers measure the resistance then convert the measured value to the desired units. The CS431 is compatible with most of our dataloggers (see datalogger compatibility in specifications).

The CS431 has a 316 stainless steel body and Viton® and Teflon® wire seals that resist corrosion. Its double-sealed cable harness protects the cable jacket and reduces the possibility of leakage. The end cone is interchangeable with a ¼" NPT inlet allowing easy hookup and field calibration. You can choose a polyurethane or Teflon cable. Both cable options are vented. An optional enhanced measurement calibration is available that allows more accurate compensation for temperature variations.

## 2. Specifications

Datalogger Compatibility: All except CR200 series; the CR500 and CR510 can measure water level only.

Available Pressure Ranges: 5, 10, 30, 50, 100 psi

Pressure Measurement Repeatability:  $\pm 0.1\%$  FSO, typical

Pressure Measurement Linearity:  $\pm 0.1\%$  FSO, typical

Temperature Error:  $\pm 2.0\%$  FSO, 0° to 40°C

Temperature Error when using Enhanced Temperature option:  $\pm 0.2\%$  FSO, 0° to 40°C

Typical Output Voltage Sensitivity: 15 to 16 mV/V at 20°C

Typical Bridge Resistance: 4 kohm at 20°C

Typical Excitation Voltage: 0.8 V

Compensated Temperature Range: 0° to 40°C

Operating Temperature Range: -5° to 70°C

Maximum Cable Length: 2000 ft

Dimensions: 0.84" (2.13 cm) diameter, 10.75" (27.31 cm) length

Weight: 3 lbs (1.4 kg) with 50 ft cable

Over Range Protection: 2X full scale range

## 3. Installation

### 3.1 Initial Inspection

Upon receipt of the CS431, inspect the packaging for any signs of shipping damage and, if found, report the damage to the carrier in accordance with policy. The contents of the package should also be inspected and a claim filed if any shipping related damage is discovered.

Care should be taken when opening the package not to damage or cut the cable jacket. If there is any question about damage having been caused to the cable jacket, a thorough inspection is prudent.

The model number and pressure range is etched on the housing. Check this information against the shipping documentation to ensure that the expected model number and range were received.

### 3.2 Vent Tube

A vent tube incorporated in the cable vents the sensor diaphragm to the atmosphere. This eliminates the need to compensate for changes in barometric pressure.

To prevent water vapor from entering the inner cavity of the sensor, the vent tube opening should terminate inside a desiccated enclosure or a desiccant tube.

### 3.3 Water Depth

For water level measurements, the CS431 must be installed below the water at a fixed depth. This depth should be chosen so that the water pressure will never exceed the sensor's pressure range. Otherwise, the output reading will not be correct, and can be damaged if pressure is excessive (2X full scale).

Pressure can be converted to feet of fresh water using the following equation:

$$1 \text{ psi} = 2.31 \text{ feet of water}$$

For example, the maximum depth with a pressure range of 0 to 5 psi is 11.55 feet of water.

### 3.4 Well Installations

Lower the transducer to an appropriate depth.

---

**CAUTION**

Do not drop the instrument or allow it to "free fall" down a well as this may damage the device.

---

Fasten the cable to the well head using cable ties or a weather proof strain-relief system (i.e., split mesh cable grip p/n 7421). The cable ties should wrap around the cable jacket; never suspend the CS431 from the connections at the top end of the cable. When securing the cable, care should be taken to avoid cable damage. Sharp bends or excessive pinching of the cable can cause damage and may pinch off the vent tube causing measurement errors.

Several readings should be taken to insure proper operation after installation.

### 3.5 Other Installations

The CS431 can be installed in any position; however, when it leaves the factory it is tested in the vertical position. Strapping the transducer body with tie wraps or tape will not hurt it.

If the CS431 is being installed in a fluid environment other than water, check the compatibility of the fluid with the wetted parts of the probe.

Because the CS431 is vented, a desiccant tube must always be attached to the CS431. When you receive the transducer, ensure that the desiccant is blue. Replace the desiccant if it is pink or white. Refer to Section 6 for more information about desiccant replacement schedule.

## 4. Wiring

### 4.1 Datalogger Connections

The pressure measurement requires two differential channels and one excitation channel, and the temperature measurement requires one single-ended channel and one excitation channel. Please note that the CR510 and CR500 dataloggers do not have enough channels to measure the temperature element. Therefore, the orange, brown, and black wires are not connected when using a CR510 or CR500.

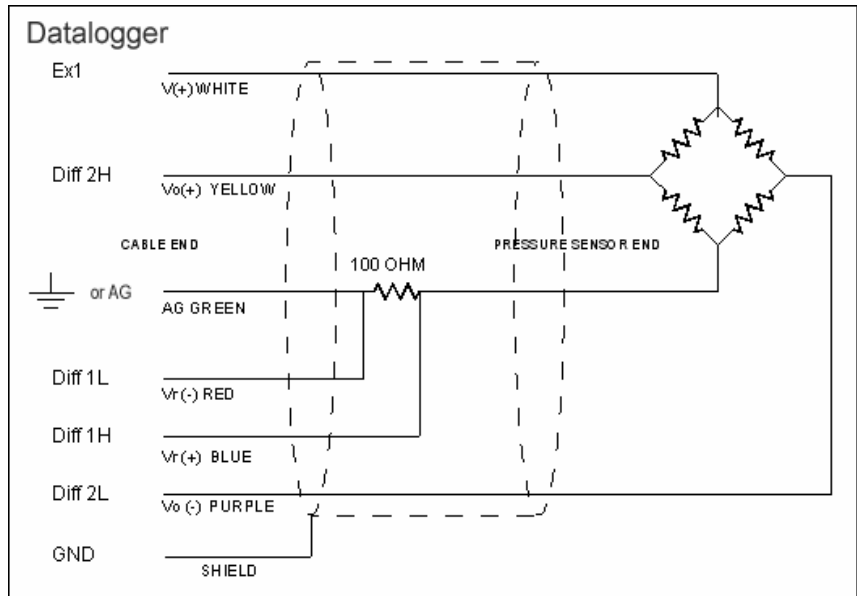

FIGURE 4.1. Typical Pressure Element Wiring

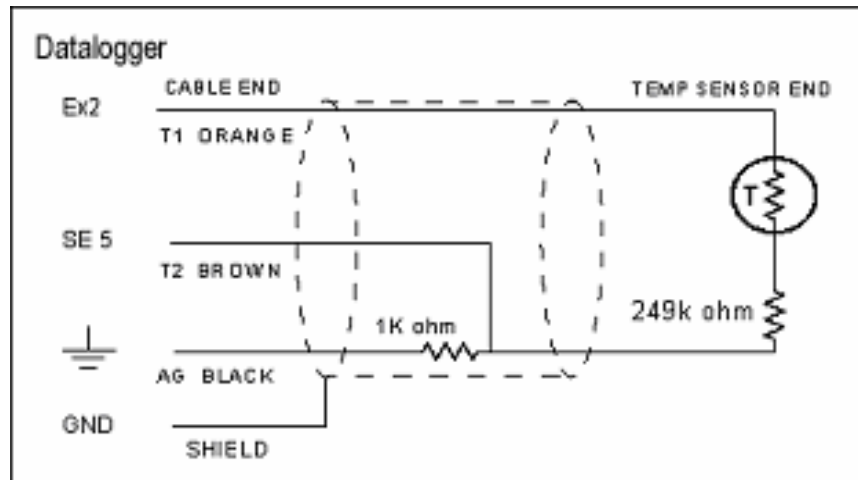

FIGURE 4-2. Typical Temperature Element Wiring

## 4.2 Grounding

**CAUTION**

Proper grounding is very important!

To prevent grounding issues, do the following:

- (1) Attach the sensor cable shield (the wrapped shield inside the cable) to the power ground (G terminal) on the datalogger.
- (2) Use a 12 AWG or larger wire to connect the datalogger's grounding lug with a grounding rod that has been driven into the earth.
- (3) If using an external power supply, tie the power supply and datalogger to the same earth ground

See also: Section 7.4 Grounding Issues.

## 5. Datalogger Programming

**NOTE**

This section is for users who write their own datalogger programs. A datalogger program to measure this sensor can be created using SCWIN ShortCut. You do not need to read this section to use ShortCut.

The following is the program structure typically used to get a pressure measurement:

- Apply 800 mV excitation across V+ (white) and AG (green).
- After a 25 millisecond delay, measure the reference voltage (Vr) across the 100 ohm resistor by measuring across Vr+ (blue) and Vr- (red).\*
- Measure the output voltage (Vo) across Vo- (purple) and Vo+ (yellow).



- Compute the normalized ratiometric output (L) as:  $L = (V_o/V_r) * 100$ .
- Apply calibration/scaling values (from INW calibration sheet) to convert to psi: multiplier \* L + offset.

To get the temperature measurement, the datalogger program should do the following:

- Apply excitation voltage across T1 (orange) and AG (black).
- Measure voltage output across T2 (brown) and AG (black).
- Apply math to process and linearize the measurement, resulting in degrees centigrade.

Two programming languages are used with our dataloggers, CRBasic and Edlog. CRBasic is compatible with our CR800, CR850, CR1000, CR3000, CR5000, and CR9000(X) dataloggers. Edlog is compatible with older dataloggers such as our CR7, CR500, CR510, CR10(X), 21X, and CR23X. Both CRBasic and Edlog are included in PC400, LoggerNet, and RTDAQ Datalogger Support Software. Example CRBasic programs are provided in Section 5.1.1. and example Edlog programs are provided in Section 5.2.1.

## 5.1 CRBasic Instructions

Apply 800 mV excitation voltage as follows:

```
ExciteV(Vx1,800,0)
```

Wait 25 milliseconds, as follows:

```
Delay(0,25,msec)
```

Use the VoltDiff( ) function to read Vr and Vo, as follows:

```
VoltDiff (Vr,1,mV25,1,false,0,_60Hz,1.0,0)
```

```
VoltDiff (Vo,1,mV25,2,true,0,_60Hz,1.0,0)
```

### NOTE

The fifth parameter (RevDiff) is false when measuring Vr and true when measuring Vo. When RevDiff is true a second measurement is made with the inputs reversed, in order to help compensate for offsets in the circuitry, thus giving a more accurate reading. On a 9805, the Vr (excitation) cannot be reversed, however, the Vo (output) can and should be to give the best readings.

Compute the L factor (normalized ratiometric output) as follows:

$$L = 100 * (V_o/V_r)$$

Apply calibration values and convert to pressure in psi as follows:

$$P = m * L + b$$

Where m and b are obtained from the calibration sheet supplied by INW.

For even more accurate readings, advanced calibration values can be applied. (See Section 5.1.1.2.)

Temperature is read using the Therm107 instruction, as follows:





```
Therm107 (Temp,1,5,Vx3,0,_60hz,1.0,0)
```

This function is designed for the thermistor used in the CS431. It automatically selects the excitation voltage and processes the result using the Steinhart-Hart calculation to get an output in degrees centigrade.

### 5.1.1 Example CRBasic Programs

The following two examples are for the CR1000 but other CRBasic dataloggers are programmed similarly. Table 5-1 shows the wiring used for these examples.

**TABLE 5-1. CR1000 Connections for Example Programs**

Single Ended Channel Number	Differential Channel Number	Sensor 1	Sensor2
1	1H	1 1H Vr+ (Blue)	
2	1L	Vr- (Red)	
		AG (Green)	
3	2H	Vo+ (Yellow)	
4	2L	Vo- (Purple)	
		Temperature AG (Black)	
5	3H	Temperature Out (Brown)	
6	3L		Temperature Out (Brown)
			
7	4H		Vr+ (Blue)
8	4L		Vr- (Red)
			AG (Green)
	Ex1	Excite (White)	Excite (White)
9	5H		Vo+ (Yellow)
10	5L		Vo- (Purple)
			Temperature AG (Black)
	Ex2	Temperature Excite (Orange)	Temperature Excite (Orange)
Ground Lug		Shield	Shield

#### 5.1.1.1 Example CR1000 PROGRAM – STANDARD CALIBRATION – Two Sensors

```

'Program = Sample Program for two CS431s
'Sensor 1 is 5 psig, Sensor 2 is 15 psig

'Declare Variables and Units
Public Mult(2)                'calibration multiplier, one per sensor
Public Offset(2)              'calibration offset, one per sensor
    'multipliers and offsets provided on INW calibration sheet

Public V(4)                   'reference voltage, then output voltage for each sensor
    'For example: V(1)=Vr for 1st sensor, V(2)=Vo for 1st sensor
    'V(3)=Vr for 2nd sensor, V(4)=Vo for 2nd sensor
    
```

(cont.)

```

Public Temp(2)                'temperature, one per sensor
Public L(2)                   'L factor (Vo/Vr * 100), one per sensor
Public P(2)                   'Standard calibrated pressure in psi, one per sensor

Public Batt_volt
Units Batt_Volt=Volts

'Define Data Tables
DataTable(Table1,True,-1)
  DataInterval(0,500,msec,10)
  Sample(1,Batt_Volt, IEEEE4)    'battery voltage
  Sample(4,V(),IEEEE4)          'excitation voltage, then output voltage, for each sensor

  'For example: V(1)=Vr for 1st sensor, V(2)=Vo for 1st sensor
  'V(3)=Vr for 2nd sensor, V(4)=Vo for 2nd sensor

  Sample (2,Temp(),Ieee4)        'temperature, one per sensor
  Sample (2,L(),Ieee4)           'L factor (Vo/Vr * 100), one per sensor
  Sample (2,P(),IEEEE4)         'Standard pressure in psi, one per sensor
EndTable

'Main Program
BeginProg

'Set multpliers and offsets - from calibration sheet
Mult(1) = 0.078165              'typical 5 psig sensor
Mult(2) = 0.1922972            'typical 15 psig sensor
Offset(1) = 0.022447           'typical 5 psig sensor
Offset(2) = 0.176678           'typical 15 psig sensor

Scan(500,mSec,1,0)             'scan once every 500 msec
  ExciteV (Vx1,800,0)           'excite voltage of 800 mV
  Delay (0,25,mSec)
  VoltDiff (V(1),1,mV25,1,false,0,_60Hz,1.0,0) 'Vr 1st sensor, diff ch 1
  VoltDiff (V(2),1,mV25,2,true,0,_60Hz,1.0,0)  'Vo 1st sensor, diff ch 2
  VoltDiff (V(3),1,mV25,4,false,0,_60Hz,1.0,0) 'Vr 2nd sensor, diff ch 4
  VoltDiff (V(4),1,mV25,5,true,0,_60Hz,1.0,0)  'Vo 2nd sensor, diff ch 5

  Therm107 (Temp(1),1,5,Vx3,0,_60hz,1.0,0)    'Temp Out 1st sensor, degC se ch 5
  Therm107 (Temp(2),1,6,Vx3,0,_60hz,1.0,0)    'Temp Out 2nd sensor, degC se ch 6

  L(1)=100*(V(2)/V(1))          'L factor for 1st sensor
  L(2)=100*(V(4)/V(3))          'L factor for 2nd sensor

  'Apply calibration values, results in psi
  P(1) = Mult(1)*L(1) + Offset(1)
  P(2) = Mult(2)*L(2) + Offset(2)

  CallTable Table1

NextScan
EndProg

```

**5.1.1.2 Example CR1000 PROGRAM – ENHANCED CALIBRATION – Two Sensors**

```
'Program = Sample Enhanced Program for two CS431s
'Sensor 1 is 5 psig, Sensor 2 is 15 psig

'Declare Variables and Units
Public m2(2)           'first calibration multiplier, one per sensor
Public m1(2)           'second calibration multiplier, one per sensor
Public m0(2)           'third calibration multiplier, one per sensor

Public b2(2)           'first calibration offset, one per sensor
Public b1(2)           'second calibration offset, one per sensor
Public b0(2)           'third calibration offset, one per sensor

Public V(4)            'reference voltage, then output voltage for each sensor
'For example: V(1)=Vr 1st sensor, V(2)=Vo 1st sensor
'V(3)=Vr 2nd sensor, V(4)=Vo 2nd sensor

Public Temp(2)         'temperature, one per sensor
Public L(2)            'L factor (Vo/Vr * 100), one per sensor
Public P(2)            'Enhanced calibrated pressure in psi, one per sensor

Public Batt_volt
Units Batt_Volt=Volts

Dim me
Dim be

'Define Data Tables
DataTable(Table1,True,-1)
  DataInterval(0,500,msec,10)
  Sample(1,Batt_Volt, IEEEE4)           'battery voltage
  Sample(4,V(),IEEEE4)                 'excitation voltage, then output voltage, each sensor

  'For example: V(1)=Vr for 1st sensor, V(2)=Vo for 1st sensor
  'V(3)=Vr for 2nd sensor, V(4)=Vo for 2nd sensor

  Sample (2,Temp(),Ieee4)              'temperature, one per sensor
  Sample (2,L(),Ieee4)                 'L factor (Vo/Vr * 100), one per sensor
  Sample (2,P(),IEEEE4)                'Standard pressure in psi, one per sensor
EndTable

'Main Program
BeginProg

'Set multpliers and offsets - from calibration sheet
'Sensor 1 (typical 5 psig sensor)
  m2(1) = -0.00000042199
  m1(1) = 0.00002049701
  m0(1) = 0.07816585737
  b2(1) = 0.00001242100
  b1(1) = 0.00099866224
  b0(1) = 0.02247116187
```

(cont.)

```

'Sensor 2 (typical 15 psig sensor)
  m2(2) = 0.000000133861
  m1(2) = 0.000001790422
  m0(2) = 0.192297242812
  b2(2) = 0.000040080304
  b1(2) = -0.001486634952
  b0(2) = 0.176678958007

Scan(500,mSec,1,0)           'scan once every 500 msec
  ExciteV (Vx1,800,0)        'excite voltage of 800 mV
  Delay (0,25,mSec)
  VoltDiff (V(1),1,mV25,1,false,0,_60Hz,1.0,0)  'Vr 1st sensor, diff ch 1
  VoltDiff (V(2),1,mV25,2,true,0,_60Hz,1.0,0)   'Vo 1st sensor, diff ch 2
  VoltDiff (V(3),1,mV25,4,false,0,_60Hz,1.0,0)  'Vr 2nd sensor, diff ch 4
  VoltDiff (V(4),1,mV25,5,true,0,_60Hz,1.0,0)   'Vo 2nd sensor, diff ch 5

  Therm107 (Temp(1),1,5,Vx3,0,_60hz,1.0,0)      'Temp Out 1st sensor, degC se ch 5,
  Therm107 (Temp(2),1,6,Vx3,0,_60hz,1.0,0)      'Temp Out 2nd sensor, degC se ch 6
  L(1)=100*(V(2)/V(1))                          'L factor for 1st sensor
  L(2)=100*(V(4)/V(3))                          'L factor for 2nd sensor

' Apply enhanced calibration values, results in psi
' Sensor 1
  me = (m2(1) * Temp(1)^2) + (m1(1) * Temp(1)) + m0(1)
  be = (b2(1) * Temp(1)^2) + (b1(1) * Temp(1)) + b0(1)
  P(1) = me * L(1) + be 'pressure in psi
' Sensor 2
  me = (m2(2) * Temp(2)^2) + (m1(2) * Temp(2)) + m0(2)
  be = (b2(2) * Temp(2)^2) + (b1(2) * Temp(2)) + b0(2)
  P(2) = me * L(2) + be           'pressure in psi

CallTable Table1

NextScan
EndProg

```

## 5.2 Edlog Instructions

To program for pressure measurement, a Instruction 8 is used to power the sensor, and measure two output voltages. The results of this measurement are then mathematically converted to pressure units. This technique automatically compensates for voltage drops in the cable and minimizes AC noise.

For programming the temperature measurement, the thermistor circuit is measured with Instruction 11. If desired INW can provide an enhanced calibration that takes the pressure and temperature measurements and mathematically corrects the pressure measurement for thermal errors. This calibration method typically reduces temperature errors by a factor of 10 (see Section 5.2.1.2).

## 5.2.1 Example Edlog Programs

The following two examples are for the CR10X but other Edlog dataloggers are programmed similarly.

### 5.2.1.1 Example CR10X PROGRAM – STANDARD – One Sensor

In the following example

V<sub>r</sub> = differential voltage at diff channel 1  
 V<sub>o</sub> = differential voltage at diff channel 2  
 L = pressure measurement in nominal units  
 P = pressure measurement in psi units using provided calibration values m and b from calibration data sheet for the specific sensor being used  
 T = temperature measurement in degrees C

```

1: Ex-Del-Diff (P8)
  1: 2      Reps
  2: 3      25 mV Slow Range
  3: 1      DIFF Channel
  4: 1      Excite all reps w/Exchan 1
  5: 1      Delay (units 0.01 sec)
  6: 800    mV Excitation
  7: 1      Loc [ Vr ]
  8: 1.0    Mult
  9: 0.0    Offset

; Calculate L factor

L=100*(Vo/Vr)

; Measure Temperature

2: Temp (107) (P11)
  1: 1      Reps
  2: 5      SE Channel
  3: 2      Excite all reps w/E2
  4: 4      Loc [ T ]
  5: 1.0    Mult
  6: 0.0    Offset

; L can be translated to a pressure measurement using the following formula,
; where m and b (in psi) are determined from device calibration sheet.

P=(m)*L + (b)

; Now data can be further processed or written to data storage memory.
    
```

**5.2.1.2 Example CR10X PROGRAM – Enhanced Measurement**

In the following example

$V_r$  = differential voltage at diff channel 1

$V_o$  = differential voltage at diff channel 2

$L$  = pressure measurement in nominal units

$m$  = calculated slope value from provided calibration values  $m_2$ ,  $m_1$ , and  $m_0$  from enhanced process calibration

$b$  = calculated offset value from provided calibration values  $b_2$ ,  $b_1$ , and  $b_0$  from enhanced process calibration

$P$  = pressure measurement in psi units using enhanced calibration values from calibration data sheet for the specific sensor being used

$T$  = temperature measurement in degrees C

1: Ex-Del-Diff (P8)

```

1: 2      Reps
2: 3      25 mV Slow Range
3: 1      DIFF Channel
4: 1      Excite all reps w/Exchan 1
5: 1      Delay (units 0.01 sec)
6: 800    mV Excitation
7: 1      Loc [ Vr ]
8: 1.0    Mult
9: 0.0    Offset

```

*; Calculate L factor*

$L=100*(V_o/V_r)$

*; Measure Temperature*

2: Temp (107) (P11)

```

1: 1      Reps
2: 5      SE Channel
3: 2      Excite all reps w/E2
4: 4      Loc [ T ]
5: 1.0    Mult
6: 0.0    Offset

```

*; L can be translated to a pressure measurement using the following formula.*

*; Coefficients for m and b are developed from thermal characterization and provided with the enhanced ;calibration sheet.*

$P=(m)*L + (b)$

*;where  $m = (m_2)*T_2 + (m_1)*T + (m_0)$  and*

*;where  $b = (b_2)*T_2 + (b_1)*T + (b_0)$*

*; Now data can be further processed or written to data storage memory.*

**5.2.1.3 Example CR10X PROGRAM – High Precision Measurement for 5 PSI Sensors**

The Standard and Enhanced Measurement Programming Examples (see Section 5.2.1.1) result in a resolution of  $\pm 0.2$  inches. These methods use the 25 mV Slow Range of the CR10X. This level of resolution is acceptable for many measurement needs. However, in the 0 – 5 PSI range, greater resolution is often needed.

Using the High Precision Measurement Programming Example (below) will result in a resolution of  $\pm 0.03$  inches. This uses the 7.5 mV Slow Range of the CR10X.

In the example below:

- V<sub>r</sub> = differential voltage at diff channel 1
- V<sub>o</sub> = differential voltage at diff channel 2
- L = pressure measurement in nominal units
- P = pressure measurement in psi units using provided calibration values m and b from calibration data sheet for the specific sensor being used
- T = temperature measurement in degrees C

```

1: Ex-Del-Diff (P8)
  1: 1      Repts
  2: 3      25 mV Slow Range
  3: 1      DIFF Channel
  4: 1      Excite all reps w/Exchan 1
  5: 1      Delay (units 0.01 sec)
  6: 800    mV Excitation
  7: 1      Loc [ Vr ]
  8: 1.0    Mult
  9: 0.0    Offset

2: Ex-Del-Diff (P8)
  1: 1      Repts
  2: 2      7.5 mV Slow Range
  3: 2      DIFF Channel
  4: 1      Excite all reps w/Exchan 1
  5: 1      Delay (units 0.01 sec)
  6: 800    mV Excitation
  7: 2      Loc [ Vo ]
  8: 1.0    Mult
  9: 0.0    Offset

; Calculate L factor

L=100*(Vo/Vr)

; Measure Temperature

3: Temp (107) (P11)
  1: 1      Repts
  2: 5      SE Channel
  3: 2      Excite all reps w/E2
  4: 4      Loc [ T ]
  5: 1.0    Mult
  6: 0.0    Offset
    
```

(cont.)



;  $L$  can be translated to a pressure measurement using the following formula,  
 ; where  $m$  and  $b$  (in psi) are determined from device calibration sheet.

$$P=(m)*L + (b)$$

; Now data can be further processed or written to data storage memory.

## 6. Maintenance

Campbell Scientific recommends that the CS431 be factory recalibrated and checked every six months. Before a CS431 probe is sent to Campbell Scientific, the customer must get an RMA (returned material authorization) and fill out the Declaration of Hazardous Material and Decontamination form.

**Transducer - all models:** There are no user-serviceable parts.

**Cable:** Cable can be damaged by abrasion, sharp objects, twisting, crimping or crushing and pulling. Take care during installation and use to avoid cable damage. If a section of cable is damaged, it is recommended that you send your sensor back to replace the cable harness assembly.

**End Connections:** The contact areas (pins & sockets) of Mil-spec connectors will wear out with extensive use. If your application requires repeated connections (in excess of 5000 connections) other types of connectors can be provided. The connectors used on the CS431 are not submersible, but are designed to be splash-resistant.

### IMPORTANT

**Desiccant Tubes:** Inspect the Desiccant Tube at least once every two months. The desiccant is a bright blue color when active and dry; as moisture is absorbed, the color will begin to fade until becoming white indicating full saturation and time to replace.

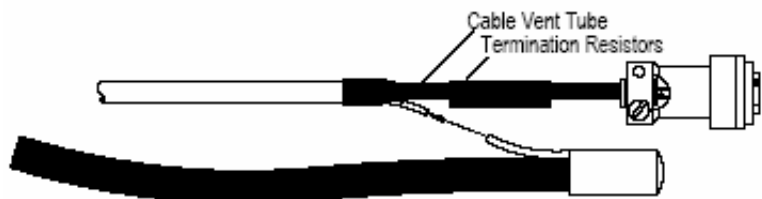

FIGURE 6-1. Desiccant Tube

## 7. Troubleshooting

### 7.1 Erratic Readings

Assuming that the datalogger is working properly, the first thing to check is the connection. Look for moisture between contacts or a loose or broken wire. If the connection appears alright, pull the transducer up to a known distance while monitoring its output. If the transducer responds as it should, but the reading is still erratic, most likely the cable is damaged. If the transducer does not respond as it should, the CS431 is most likely damaged. In either case, consult the factory.

Improper grounding can also cause erratic and erroneous readings (see Section 7.3—Grounding Issues).

### 7.2 Oscillating Readings Over Time

If your transducer is functioning properly but a cyclic effect is recorded in your data when water level changes have not occurred, you are probably seeing barometric changes. The amount is usually 0.5 to 1.5 feet of water. This can be caused by a plugged vent tube in the cable or actual water level changes in the aquifer itself in response to barometric pressure changes. This effect can occur in tight formations where the transducer will immediately pick up barometric changes but the aquifer will not. If you suspect you are having this type of problem, you should record the barometric pressure as well as the water level pressure and compensate the data.

If it appears that the vent tube is plugged, consult the factory. If a desiccant tube is not installed in line with the cable, water may have condensed in your vent tube causing it to plug. After you are finished installing the desiccant tube you can test the vent tube by applying a small amount of pressure to the end of the desiccant tube and seeing if this affects the transducer reading.

### 7.3 Zero Readings When Pressurized

An open circuit will cause continuous zero readings, which usually indicates a broken cable, a bad connection, or possibly a damaged transducer. Check the connector to see if a wire is loose, or if the cable has been cut. If these are not causing the problem, the transducer needs factory repair.

### 7.4 Grounding Issues

Both personnel and equipment need to be protected from high power spikes that may be caused by lightning, power line surges, or faulty equipment. Without a proper grounding system, a power spike will find the path of least resistance to earth ground – whether that path is through sensitive electronic equipment or the person operating the equipment. In order to ensure safety and prevent equipment damage, a grounding system must be used to provide a low resistance path to ground.

When using several pieces of interconnected equipment, each of which may have its own ground, problems with noise, signal interference, and erroneous readings may be noted. This is caused by a condition known as a *Ground Loop*. Because of natural resistance in the earth between the grounding points, current can flow between the points, creating an unexpected voltage difference and resulting erroneous readings.

The best method for minimizing ground loops is to tie all equipment (sensors, dataloggers, external power sources and any other associated equipment) to a **single common grounding point**.

To prevent grounding issues, do the following:

- (1) Attach the sensor cable shield (the wrapped shield inside the cable) to the power ground (G terminal) on the datalogger.
- (2) Use a 12 AWG or larger wire to connect the datalogger's grounding lug with a grounding rod that has been driven into the earth.
- (3) If using an external power supply, tie the power supply and datalogger to the same earth ground.





## **Campbell Scientific Companies**

---

### **Campbell Scientific, Inc. (CSI)**

815 West 1800 North  
Logan, Utah 84321  
UNITED STATES  
www.campbellsci.com  
info@campbellsci.com

### **Campbell Scientific Africa Pty. Ltd. (CSAf)**

PO Box 2450  
Somerset West 7129  
SOUTH AFRICA  
www.csafrica.co.za  
cleroux@csafrica.co.za

### **Campbell Scientific Australia Pty. Ltd. (CSA)**

PO Box 444  
Thuringowa Central  
QLD 4812 AUSTRALIA  
www.campbellsci.com.au  
info@campbellsci.com.au

### **Campbell Scientific do Brazil Ltda. (CSB)**

Rua Luisa Crapsi Orsi, 15 Butantã  
CEP: 005543-000 São Paulo SP BRAZIL  
www.campbellsci.com.br  
suporte@campbellsci.com.br

### **Campbell Scientific Canada Corp. (CSC)**

11564 - 149th Street NW  
Edmonton, Alberta T5M 1W7  
CANADA  
www.campbellsci.ca  
dataloggers@campbellsci.ca

### **Campbell Scientific Ltd. (CSL)**

Campbell Park  
80 Hathern Road  
Shepshed, Loughborough LE12 9GX  
UNITED KINGDOM  
www.campbellsci.co.uk  
sales@campbellsci.co.uk

### **Campbell Scientific Ltd. (France)**

Miniparc du Verger - Bat. H  
1, rue de Terre Neuve - Les Ulis  
91967 COURTABOEUF CEDEX  
FRANCE  
www.campbellsci.fr  
info@campbellsci.fr

### **Campbell Scientific Spain, S. L.**

Psg. Font 14, local 8  
08013 Barcelona  
SPAIN  
www.campbellsci.es  
info@campbellsci.es