

CS241

PT-1000 Class A,
Back-of-Module
Temperature Sensor



Table of contents

1. Introduction	1
2. Precautions	1
3. Initial inspection	1
4. QuickStart	2
5. Overview	4
6. Specifications	6
7. Installation	7
7.1 Circuit diagrams	8
7.2 Wiring	9
7.3 Data logger programming	11
7.3.1 Resistance measurement and conversion to temperature	12
7.4 Placement on a photovoltaic (PV) module	13
7.5 Mounting/cable strain relief	13
7.5.1 Adhesive mounting strip	13
7.5.2 Cable strain relief	13
7.5.3 Extreme sealing tape	15
7.6 Cable resistance/long cable lengths	16
7.7 Electrical noisy environments	17
8. Maintenance and troubleshooting	18
8.1 Maintenance	18
8.2 Troubleshooting	18
Appendix A. Importing Short Cut code into CRBasic Editor	19
Appendix B. Sensor material properties	20
B.1 3M F9473PC adhesive	20

1. Introduction

The CS241 temperature sensor uses a precision 1000 ohm Class A platinum resistance thermometer (PRT) to measure temperature. It is designed for measuring the back-of-photovoltaic (PV) module temperature but also can be used to measure the surface temperature of other devices. The CS241 can be measured with a 2-wire or 4-wire configuration and is compatible with most Campbell Scientific data loggers.

NOTE:

This manual provides information only for CRBasic data loggers. The sensor is also compatible with our retired Edlog data loggers. For Edlog data logger support, contact Campbell Scientific. Support for Edlog data loggers is no longer free; see www.campbellsci.com/news-edlog-retiring  for more information.

2. Precautions

- READ AND UNDERSTAND the [Safety](#) section at the back of this manual.
- Do not use epoxy to secure the sensor head to a PV module.
- Before mounting, the installers need to wash their hands and then clean the back of the PV module or other device using the isopropyl alcohol pad shipped with the sensor.
- Prying the sensor head off will likely damage both the sensor and PV module.
- Proper strain relief of the cable is required after mounting the sensor to the measurement surface ([Mounting/cable strain relief](#) (p. 13)).
- Placement of the cable inside a rugged conduit is advisable for cable runs over 4.5 m (15 ft), especially in locations subject to digging, mowing, traffic, power tools, animals, or lightning strikes.



3. Initial inspection

- Upon receipt of the sensor, inspect the packaging and contents for damage. File damage claims with the shipping company.

- The model number, cable length, and cable resistance are printed on a label at the connection end of the cable. Check this information against the shipping documents to ensure the expected product and cable length were received.

4. QuickStart

A video that describes data logger programming using *Short Cut* is available at:

www.campbellsci.com/videos/cr1000x-data-logger-getting-started-program-part-3 . *Short Cut* is an easy way to program your data logger to measure the sensor and assign data logger wiring terminals. *Short Cut* is available as a download on www.campbellsci.com . It is included in installations of *LoggerNet*, *RTDAQ*, or *PC400*.

The following procedure also shows using *Short Cut* to program the CS241.

1. Open *Short Cut* and click **Create New Program**.
2. Double-click the data logger model.
3. In the **Available Sensors and Devices** box, type CS241. You can also locate the sensor in the **Sensors > Temperature** folder. Double click the sensor model. The surface temperature defaults to degree C. This can be changed by clicking the **Temperature** box and selecting one of the other options. If using the 2-wire configuration, type the **Cable Resistance**. This value is unique for each sensor, and is printed on the heat shrink label attached to the sensor cable.

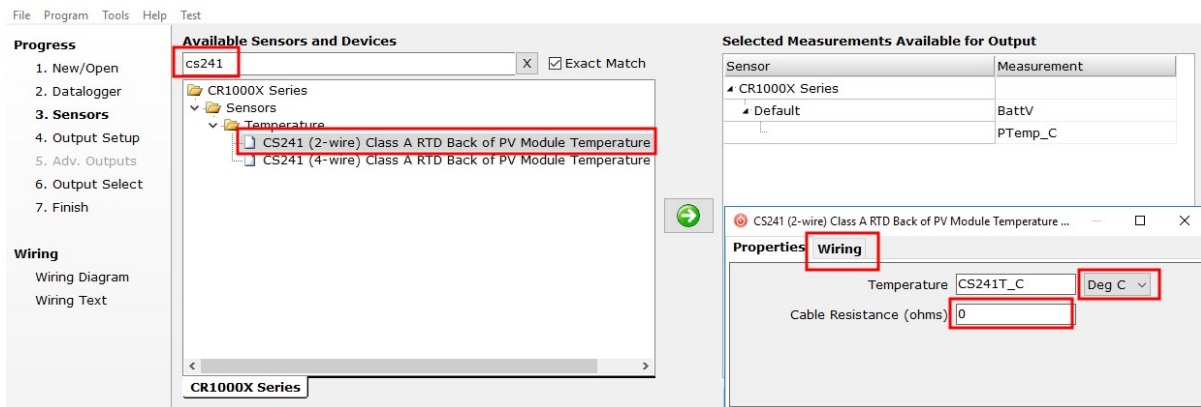

- Click on the **Wiring** tab to see how the sensor is to be wired to the data logger. Click **OK** after wiring the sensor.

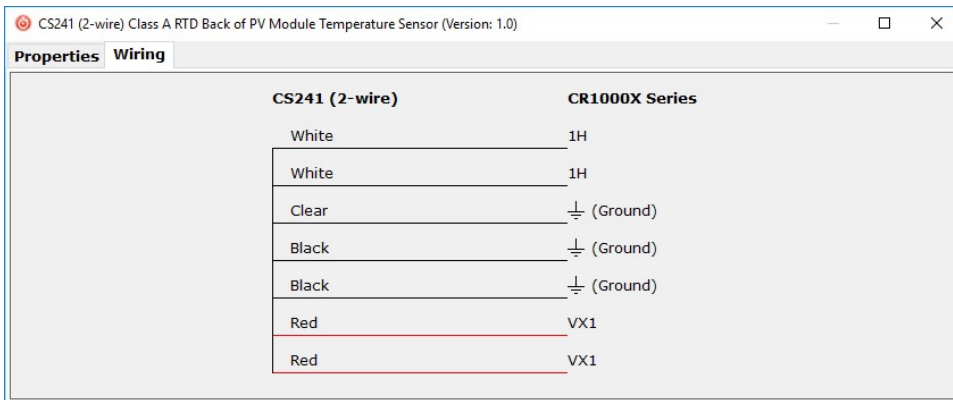

- Repeat steps three and four for other sensors you want to measure. Click **Next**.
- In **Output Setup**, type the scan rate, a meaningful table name, and the **Data Output Storage Interval**.

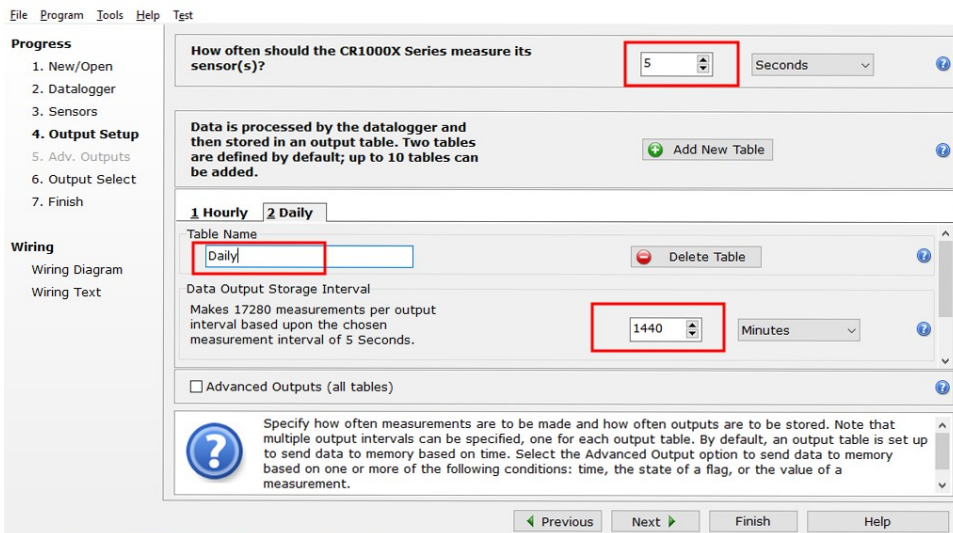

7. Select the measurement and its associated output option.

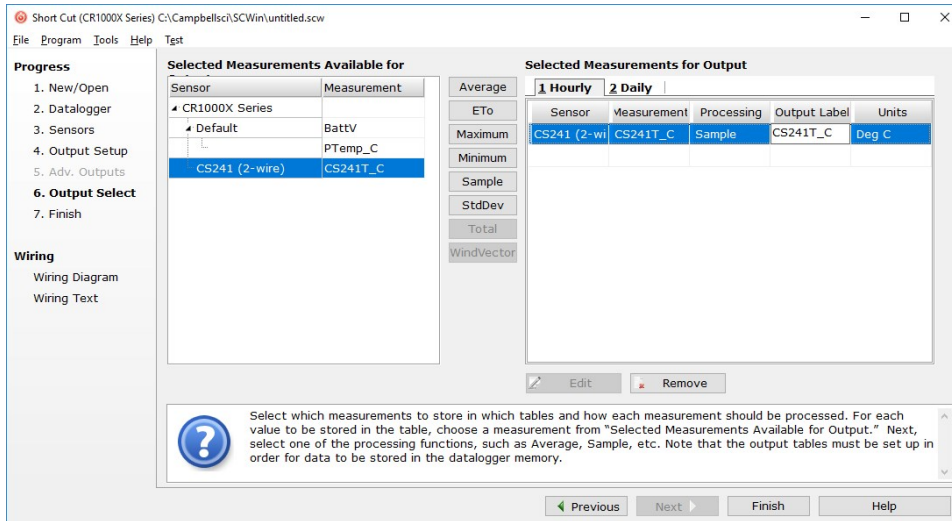

8. Click **Finish** and save the program. Send the program just created to the data logger if the data logger is connected to the computer.
9. If the sensor is connected to the data logger, check the output of the sensor in the data logger support software data display in *LoggerNet*, *RTDAQ*, or *PC400* to make sure it is making reasonable measurements.

5. Overview

The CS241 is a surface mountable platinum resistive thermometer (PRT) that measures back-of-module temperature for solar energy applications. It uses a precision PT-1000 Class A PRT to provide the highest level of accuracy. To withstand the harsh treatment that commonly occurs with meteorological station installation, the sensing element is safely housed inside a specially designed self-adhesive aluminum disk (FIGURE 5-1 (p. 5)).

The disk protects the PRT, particularly during installation, and promotes heat transfer from the surface. An adhesive tab on the disk fastens the sensor to the measurement surface.

The CS241 provides PV stakeholders with highly accurate back-of-module temperature, even at long cable lengths, in power performance modeling and simulation of solar energy applications. Back-of-module temperature is critical for any evaluation of effective irradiance and power conversion.



FIGURE 5-1. CS241 temperature sensor

Benefits and features:

- Designed for optimal performance on bifacial PV module
- Easy installation with maximum sensor-to-module bonding strength and smaller profile
- NIST-traceable, serialized calibration certificate supplied with every sensor
- Meets or exceeds IEC 61724 Class A performance specifications
- Precision PT-1000 Class A sensing element
- Compliant with IEC 60751, DIN EN 60751 (according to IEC 751)
- Suitable for use on floating PV arrays
- Slim design to minimize sensor impact on bifaciality (<2% of full-size cell area)
- Thermal conductance greater than 600 W/(m² K)
- Maximum sensor-to-module bonding
- High temperature rating to 150 °C
- User-selectable and standard cable lengths offered
- 2-wire or 4-wire configurations to satisfy accuracy even at long cable lengths
- Compatible with Campbell Scientific CRBasic data loggers: CR6, CR3000, CR1000X, CR800 series, CR300 series, CR1000

6. Specifications

Sensor:	Precision 1000 ohm Class A platinum sensing element
Class A sensor accuracy:	$\pm (0.15 + 0.002t)$ °C
Operating temperature range:	-40 to 150 °C
Temperature coefficient:	TCR = 3850 ppm/K
Long-term stability:	Maximum R_0 drift = 0.04% after 1000 hours at 400 °C
Measuring current:	0.1 to 0.3 mA
Temperature uncertainty:	$\pm(0.3$ to 0.4 °C) for the -40 to 100 °C measurement range when using the CR1000X data logger
Disk diameter:	2.54 cm (1.0 in)
Height:	0.419 cm (0.165 in)
Disk material:	Anodized aluminum
Weight:	~27 g (0.06 lb) with 1 m (3 ft) cable
Approvals:	Conforms with the Restriction of Hazardous Substances Directive (RoHS2)
Compliance:	View compliance documents at: www.campbellsci.com/cs241 Meets or exceeds IEC 61724 Class A performance specifications
Industrial standards:	Compliant with IEC 60751, DIN EN 60751, Industrial Design (IEC Class 4) (according to IEC 751)
IP rating:	IP68 rating (self certified): 1 m (3 ft) submersion for 90 minutes
EMC compliance:	Conforms with Electromagnetic Compatibility Directive (EMC)
RoHS2:	Conforms with Restriction of Hazardous Substances Directive (RoHS2)
POE compliance:	POE compliant (802.3af) to 100 meters when installed per recommendations in TIA TSB-184

CAT5e: Cable will meet CAT5e channel requirements to 100 meter length

Sensor cable (sensor head-to-M12 connector)

Cable diameter: 0.216 cm (0.085 in)
Cable length: 0.9 m (3 ft)
Jacket material: White semi-gloss perfluoroalkoxy (PFA), insulated
Jacket rating: -75 to 250 °C
Minimum bend radius: 6 mm (0.25 in) at least 6 mm (0.25 in) away from sensor disk
Connector: Circular plastic M12 , male 8-pin connector

Main cable (M12 connector to pigtail)

Cable diameter: 0.622 cm (0.245 in)
Jacket material: Black semi-gloss polyvinyl chloride (PVC), UL VW-1 sunlight resistant for outdoor use
UL: AWM 10012 1000V 105 °C

7. Installation

If you are programming your data logger with *Short Cut*, skip [Wiring](#) (p. 9) and [Data logger programming](#) (p. 11). *Short Cut* does this work for you. See [QuickStart](#) (p. 2) for a *Short Cut* tutorial. This section discusses the following:

7.1 Circuit diagrams	8
7.2 Wiring	9
7.3 Data logger programming	11
7.4 Placement on a photovoltaic (PV) module	13
7.5 Mounting/cable strain relief	13
7.6 Cable resistance/long cable lengths	16
7.7 Electrical noisy environments	17

7.1 Circuit diagrams

FIGURE 7-1 (p. 8) provides the circuit diagram for the 2-wire configuration. FIGURE 7-2 (p. 8) provides the circuit diagram for the 4-wire configuration.

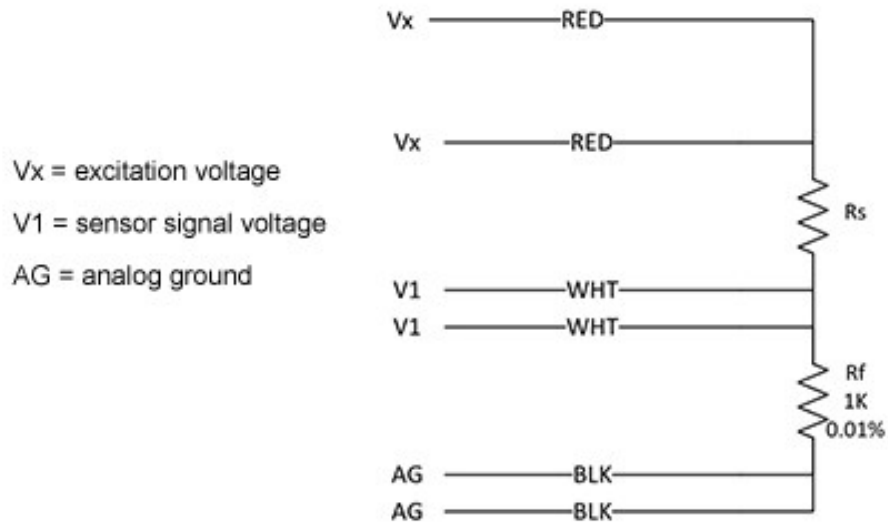

FIGURE 7-1. 2-Wire Circuit Diagram

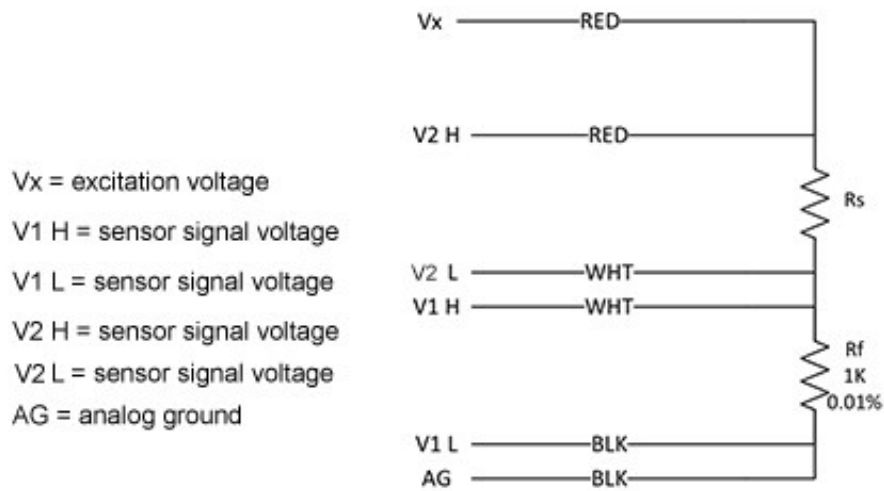

FIGURE 7-2. 4-Wire Circuit Diagram

7.2 Wiring

The CS241 sensor head includes a short, white cable with a circular plastic M12 type male 8-pin connector. A second cable with a mating circular plastic M12 type female 8-pin connector is used to attach the sensor to the data logger (see [FIGURE 7-3](#) (p. 9)). This cable is typically a black UV resistant, semi-gloss cable purchased with the CS241. However, a user-supplied cable can be used. [Table 7-1](#) (p. 10) and [Table 7-2](#) (p. 11) show the pin configuration. Using connectors between the sensor head and the data logger cable allows in-field sensor head replacement without disconnecting the cable from the data logger. Detailed information about the cables are provided in the [Specifications](#) (p. 6).

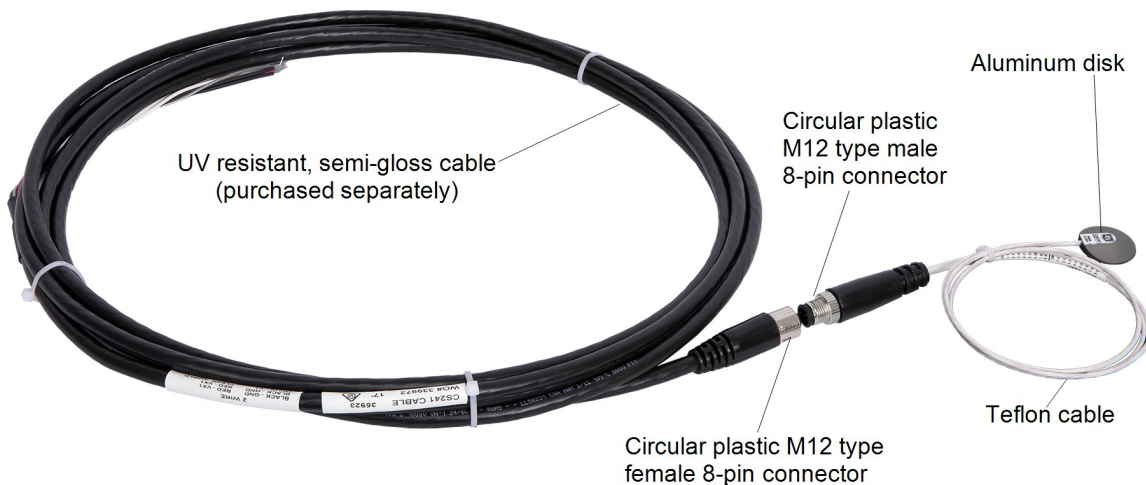

FIGURE 7-3. CS241 with black UV-resistant, semi-gloss cable

A fixed resistor is in the M12, male connector (see the following figure).

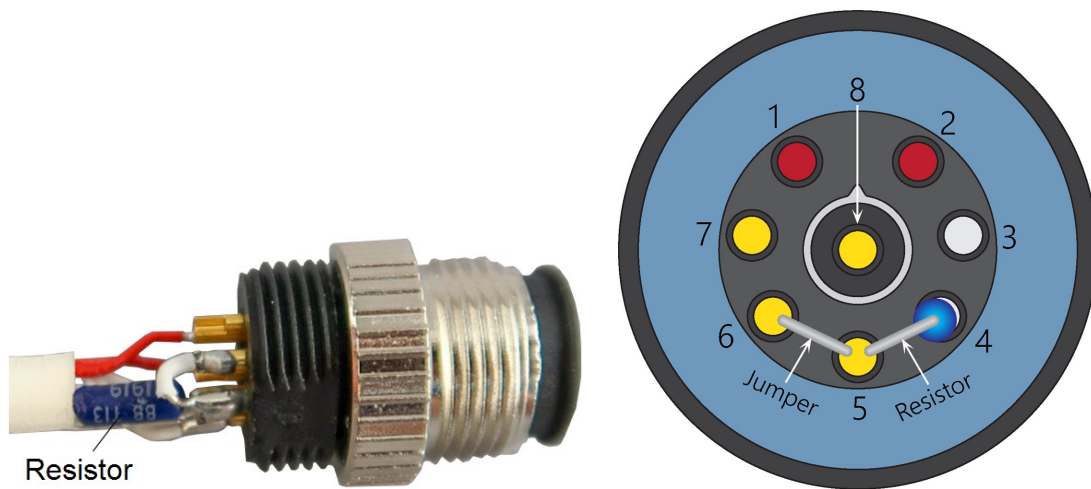

FIGURE 7-4. Resistor in M12 male connector. Right image shows pin numbers.

The data logger can measure the CS241 using either a 2-wire or 4-wire configuration. The 2-wire configuration accuracy decreases, relative to the 4-wire, as a function of the cable length. The 4-wire configuration eliminates resistance due to cable length and is the most accurate way to measure this sensor. The following tables provide the data logger connections for the 2-wire and 4-wire configurations.

Wire color	Pin number	Wire function	Data logger connection
Red	1	Voltage excitation	U configured for voltage excitation ¹ , EX, VX (voltage excitation)
Red	2	Voltage excitation	U configured for voltage excitation ¹ , EX, VX (voltage excitation)
White	3	Signal	U configured for single-ended analog input ¹ , SE (single-ended, analog-voltage input)
White	4	Signal	U configured for single-ended analog input ¹ , SE (single-ended, analog-voltage input)
Black	5	Signal reference	⊥ (analog ground)
Black	6	Signal reference	⊥ (analog ground)
Clear	N/C	Shield	⊥ (analog ground)

¹U terminals are automatically configured by the measurement instruction.

Table 7-2: Wire color, function, and data logger connection for 4-wire configuration

Wire color	Pin number	Wire function	Data logger connection
Red	1	Voltage excitation	U configured for voltage excitation ¹ , EX, VX (voltage excitation)
Red	2	Signal, high	U configured for differential input ¹ , DIFF H (differential high, analog-voltage input)
White	3	Signal reference	U configured for differential input ¹ , DIFF L (differential low, analog-voltage input)
White	4	Signal, high	U configured for differential input ¹ , DIFF H (differential high, analog-voltage input)
Black	5	Signal reference	U configured for differential input ¹ , DIFF L (differential low, analog-voltage input)
Black	6	Ground	⊥ (analog ground)
Clear	N/C	Shield	⊥ (analog ground)

¹U terminals are automatically configured by the measurement instruction.

7.3 Data logger programming

Short Cut is the best source for up-to-date data logger programming code. If your data acquisition requirements are simple, you can probably create and maintain a data logger program exclusively with **Short Cut**. If your data acquisition needs are more complex, the files that **Short Cut** creates are a great source for programming code to start a new program or add to an existing custom program.

NOTE:

Short Cut cannot edit programs after they are imported and edited in **CRBasic Editor**.

A **Short Cut** tutorial is available in [QuickStart](#) (p. 2). If you wish to import **Short Cut** code into **CRBasic Editor** to create or add to a customized program, follow the procedure in [Importing Short Cut code into CRBasic Editor](#) (p. 19). Programming basics for CRBasic data loggers are provided in the following section. Downloadable program example is available at www.campbellsci.com/downloads/cs241-example-programs .

If applicable, please read [Electrical noisy environments](#) (p. 17) and [Cable resistance/long cable lengths](#) (p. 16) prior to programming your data logger.

7.3.1 Resistance measurement and conversion to temperature

The CS241 program needs to measure the resistance of the CS241 then convert that resistance measurement to temperature. Accurate resistance measurements require a high-precision fixed resistor with low thermal coefficient. The CS241 includes a 1000 Ohm metal film resistor with 0.05% accuracy and 10 ppm or better thermal coefficient in the connector on the sensor side.

A 4-wire measurement using two differential analog terminals provides the most accurate measurement and gets rid of resistance of the long cable lengths often needed in a field installation. The following is a typical 4-wire measurement instruction for the CR1000X data logger:

```
BrHalf4W(CS241X,1,mV200,mV200,1,VX1,1,350,True,True,0,15000,1,0)
'Convert ratio to ohms
CS241Rs=CS241X *1000 '(1000 is the value of the fixed resistor)
'Calculate temperature from resistance
'1000 is the resistance of the PRT at 0 degree C
PRTCalc(CS241T_4W,1,CS241Rs/1000,1,1,0)
```

A 2-wire measurement using only one single ended analog terminal can also measure the sensing element resistance. In this case, the sensor-cable resistance (R_w) is included in the measurement. With careful analysis of the circuit, some of this error can be removed if the cable resistance is known. The cable resistance is provided on the sensor cable for this purpose. This resistance will vary with temperature and hence the correction is only approximate. The following is a typical 2-wire instruction for the CR1000X:

```
BrHalf(CS241X,1,mV200,5,VX1,1,350,True,0,15000,1,0)
'Convert ratio to ohms and remove cable resistance
'1000 is the value of the fixed resistor
CS241Rs=1000*((1-CS241X)/CS241X) + (Rw/2)*((1-2*CS241X)/CS241X)
'Calculate temperature from resistance
'1000 is the resistance of the PRT at 0 degree C
PRTCalc(CS241T_2W,1,CS241Rs/1000,1,1,0)
```

Where:

R_w is the cable resistance as shown on the cable

NOTE:

The CS241 is wired differently from what is shown in the help for instruction [BrHalf\(\)](#).

7.4 Placement on a photovoltaic (PV) module

The PV module may or may not have distinctive photocells. If the PV module does not have distinctive photocells, center the sensor on the back of the PV module. If the module has several distinctive photocells, center the sensor on the back of the photocell that is the middle of the PV module.

7.5 Mounting/cable strain relief

CAUTION:

Before mounting, the installers need to wash their hands and then clean the back of the PV module or other device using the isopropyl alcohol pad shipped with the sensor.

7.5.1 Adhesive mounting strip

A pressure-activated adhesive mounting strip is adhered to the flat surface of the aluminum disk. To mount the sensor, remove the paper from the mounting strip and place the disk on the back of the PV module or other device. Press the disk firmly for 2 to 3 seconds to initiate long-term bonding of the sensor to the surface. The mounting strip must be adhered to a clean surface for its adhesive to function properly.

CAUTION:

Do not use epoxy to secure the sensor head to a PV module.

7.5.2 Cable strain relief

NOTE:

Placement of the cable inside a rugged conduit is advisable for cable runs over 4.5 m (15 ft), especially in locations subject to digging, mowing, traffic, power tools, animals, or lightning strikes.

The cable must be properly strain relieved after mounting the sensor to the measurement surface. To accomplish this, the CS241 comes with three cable ties and three edge clips.

1. Fasten the edge clips at the top of the PV module in the following locations:
 - a. Above the sensor



- b. Next to the cable connector

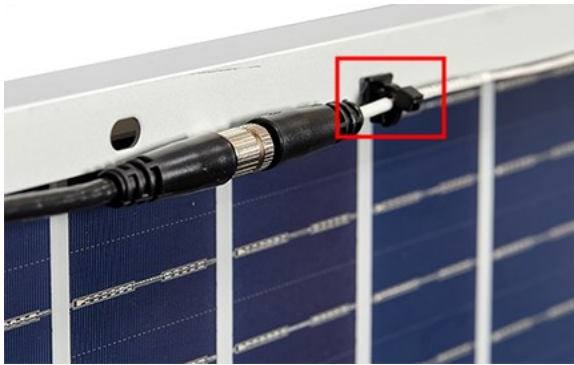

- c. At a top corner of the PV module

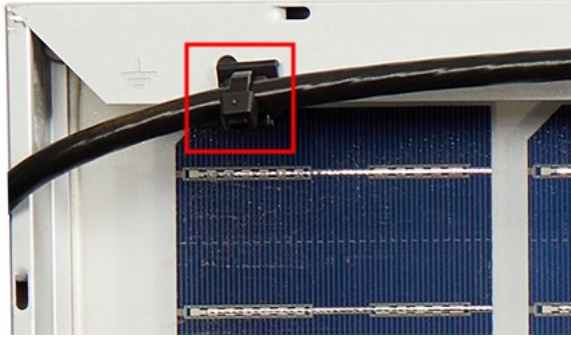

2. Use the cable ties to secure the cable to the edge clips.

7.5.3 Extreme sealing tape

The CS241 was designed to minimize surface area and mass. This design minimizes the effects of installation on bifacial modules and also increases the adhesion properties of the sensor to the module surface. When back-of-module temperatures may exceed 150 °C, use extreme sealing tape for additional adhesion and cabling relief.

To ensure the sensor disk and cable are adequately fastened to the measurement surface, use three strips of tape in two places each:

1. For strain relief, place the first strip of tape across the cable 20 to 40 cm (8 to 16 in) from the sensor head and rub the tape surface to remove bubbles.
2. Place the other strips of tape perpendicular and on top of the first strip of tape and rub the tape surface to remove bubbles. These strips of tape should form an H (FIGURE 7-5 (p. 16)).
3. To secure the sensor to the module surface, remove the paper from the bottom of the disk and adhere the disk to the PV module (Placement on a photovoltaic (PV) module (p. 13)).
4. Place a strip of tape across the sensor head, perpendicular to the cable and rub the tape surface to remove bubbles. Rub as close as possible to the sensor disk.
5. Place the two other strips of tape on the ends of the sensor disk, perpendicular to the first piece of tape and parallel to the cable then rub the tape surface into the module surface. See the following figure.

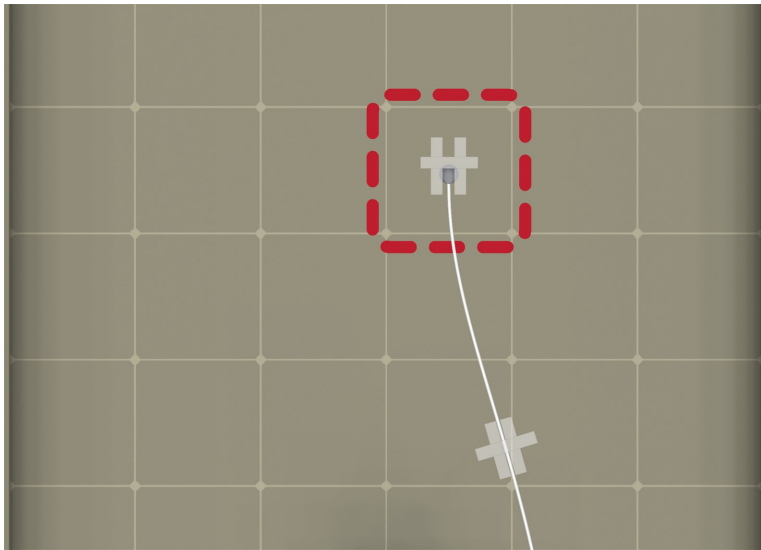

FIGURE 7-5. Proper tape usage

7.6 Cable resistance/long cable lengths

Placement of the cable inside a rugged conduit is advisable for cable runs over 4.5 m (15 ft), especially in locations subject to digging, mowing, traffic, power tools, animals, or lightning strikes.

Cable resistance can cause significant error ([FIGURE 7-6](#) (p. 17)). The 4-wire half bridge configuration is the best configuration for long cable lengths.

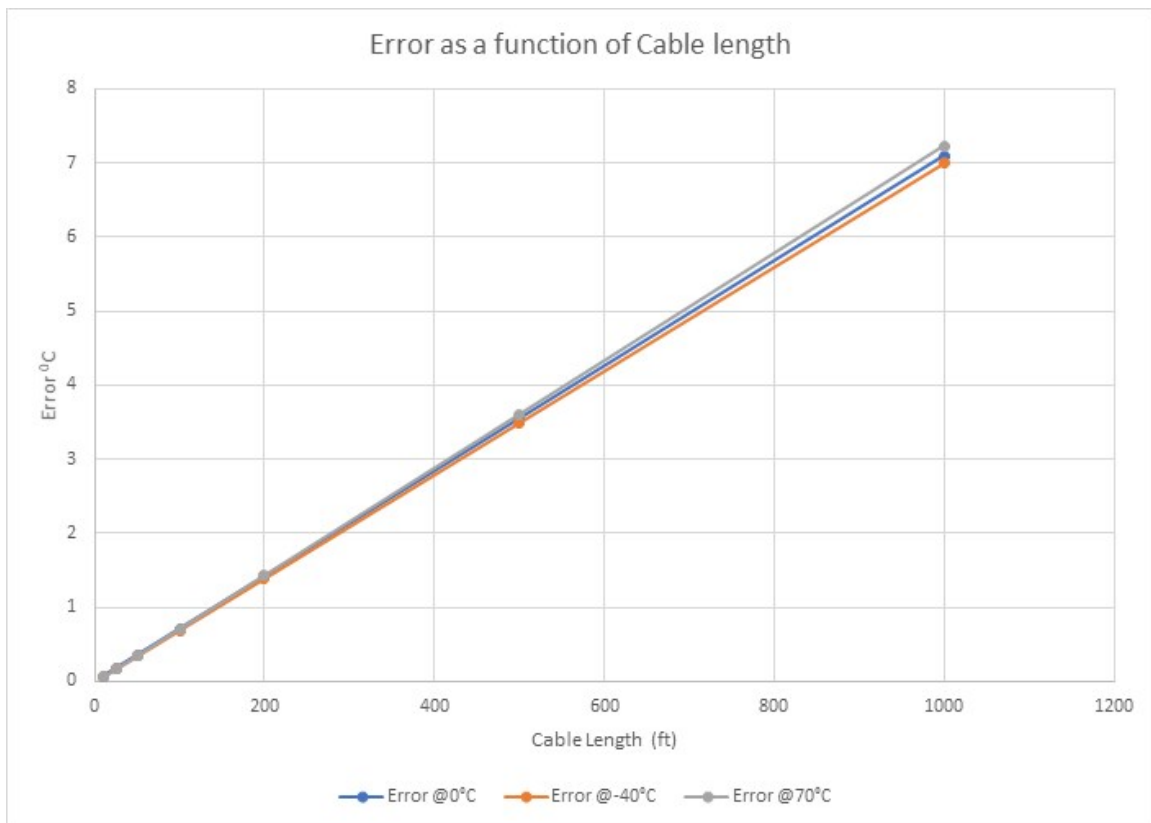

FIGURE 7-6. BrHalf (2-wire half bridge) measurement error as a function of cable length

The heat shrink label on the cable provides the cable resistance (ohms). When using the 2-wire configuration, subtract this cable resistance from the measured resistance value. The value included on the label is calculated with the following equation:

$$\text{Cable resistance} = 0.0274 \text{ ohm/feet} \times \text{cable length (in feet)}$$

Additional settling time may be required for cable lengths longer than 91 m (300 ft), where settling time is the delay before the measurement is made. The 60 and 50 Hz integration options include a 3 ms settling time; longer settling times can be typed into the **Settling Time** parameter in the [BrHalf4W\(\)](#) or [BrHalf\(\)](#) instruction.

7.7 Electrical noisy environments

AC power lines, pumps, power inverters, and motors can be the source of electrical noise. If the sensor or data logger is located in an electrically noisy environment, the sensor should be measured with the 60 or 50 Hz rejection option.

8. Maintenance and troubleshooting

NOTE:

For all factory repairs, customers must get an RMA number. Customers must also properly fill out a “Declaration of Hazardous Material and Decontamination” form and comply with the requirements specified in it. Refer to the [Assistance](#) page at the back of this manual for more information.

8.1 Maintenance

The CS241 sensor requires minimal maintenance. Periodically check cabling for proper connections, signs of damage, and possible moisture intrusion.

8.2 Troubleshooting

Symptom: Temperature is NAN, -INF, -9999, -273

Verify wiring of sensor to the data logger; cross-reference data logger program or the measurement system wiring diagram.

Symptom: Incorrect Temperature

Check the cable for signs of damage and possible moisture intrusion.

Check measurement instruction multiplier and offset.

Symptom: Unstable Temperature

Make sure the clear shield wire is connected to data logger ground, and the data logger is properly grounded. Try using the 60 or 50 Hz integration options and/or increasing the settling time.

Appendix A. Importing *Short Cut* code into *CRBasic Editor*

Short Cut creates a .DEF file that contains wiring information and a program file that can be imported into the *CRBasic Editor*. By default, these files reside in the C:\campbellsci\SCWin folder.

Import *Short Cut* program file and wiring information into *CRBasic Editor*:

1. Create the *Short Cut* program. After saving the *Short Cut* program, click the **Advanced** tab then the **CRBasic Editor** button. A program file with a generic name will open in CRBasic. Provide a meaningful name and save the CRBasic program. This program can now be edited for additional refinement.

NOTE:

Once the file is edited with *CRBasic Editor*, *Short Cut* can no longer be used to edit the program it created.

2. To add the *Short Cut* wiring information into the new CRBasic program, open the .DEF file located in the C:\campbellsci\SCWin folder, and copy the wiring information, which is at the beginning of the .DEF file.
3. Go into the CRBasic program and paste the wiring information into it.
4. In the CRBasic program, highlight the wiring information, right-click, and select **Comment Block**. This adds an apostrophe (') to the beginning of each of the highlighted lines, which instructs the data logger compiler to ignore those lines when compiling. The **Comment Block** feature is demonstrated at about 5:10 in the [CRBasic | Features](#) video .

Appendix B. Sensor material properties

The sensor consists of 6061 aluminum (hard anodized), RTD, 3M F9473PC adhesive, PFA-jacketed cable, and Santoprene® connector.

B.1 3M F9473PC adhesive

UV resistance: Excellent UV resistance through outdoor weathering tests.

Temperature resistance: Relatively unaffected by long-term exposure to elevated temperatures. Adhesive can tolerate periodic short-term exposures to temperatures up to 260 °C. The adhesive softens as temperature increases and gets firmer as temperature decreases. As the adhesive becomes firmer, the bond strength generally increases. However, at very low temperatures (< -40 °C), the bond strength decreases.

Solvent resistance: No apparent degradation when exposed to splash testing of many common solvents and fluids including gasoline, JP-4 fuel, mineral spirits, motor oil, ammonia cleaner, acetone and methyl ethyl ketone. Three-splash testing cycles were 20 seconds submersion and 20 seconds air dry.

Storage and shelf life: Humidity controlled storage: 16 to 27 °C (60 to 80 °F) and 40 to 60% relative humidity. If stored properly, product retains its performance and properties for 24 months from date of manufacture. If the products have been exposed to severe weather conditions, we suggest to precondition the products at the above storage conditions for at least 24 hours before using them.

Limited warranty

Products manufactured by Campbell Scientific are warranted by Campbell Scientific to be free from defects in materials and workmanship under normal use and service for twelve months from the date of shipment unless otherwise specified on the corresponding product webpage. See Product Details on the Ordering Information pages at www.campbellsci.com[↗]. Other manufacturer's products, that are resold by Campbell Scientific, are warranted only to the limits extended by the original manufacturer.

Refer to www.campbellsci.com/terms#warranty[↗] for more information.

CAMPBELL SCIENTIFIC EXPRESSLY DISCLAIMS AND EXCLUDES ANY IMPLIED WARRANTIES OF MERCHANTABILITY OR FITNESS FOR A PARTICULAR PURPOSE. Campbell Scientific hereby disclaims, to the fullest extent allowed by applicable law, any and all warranties and conditions with respect to the Products, whether express, implied or statutory, other than those expressly provided herein.

Assistance

Products may not be returned without prior authorization.

Products shipped to Campbell Scientific require a Returned Materials Authorization (RMA) or Repair Reference number and must be clean and uncontaminated by harmful substances, such as hazardous materials, chemicals, insects, and pests. Please complete the required forms prior to shipping equipment.

Campbell Scientific regional offices handle repairs for customers within their territories. Please see the back page for the Global Sales and Support Network or visit www.campbellsci.com/contact  to determine which Campbell Scientific office serves your country.

To obtain a Returned Materials Authorization or Repair Reference number, contact your CAMPBELL SCIENTIFIC regional office. Please write the issued number clearly on the outside of the shipping container and ship as directed.

For all returns, the customer must provide a "Statement of Product Cleanliness and Decontamination" or "Declaration of Hazardous Material and Decontamination" form and comply with the requirements specified in it. The form is available from your CAMPBELL SCIENTIFIC regional office. Campbell Scientific is unable to process any returns until we receive this statement. If the statement is not received within three days of product receipt or is incomplete, the product will be returned to the customer at the customer's expense. Campbell Scientific reserves the right to refuse service on products that were exposed to contaminants that may cause health or safety concerns for our employees.

Safety

DANGER — MANY HAZARDS ARE ASSOCIATED WITH INSTALLING, USING, MAINTAINING, AND WORKING ON OR AROUND **TRIPODS, TOWERS, AND ANY ATTACHMENTS TO TRIPODS AND TOWERS SUCH AS SENSORS, CROSSARMS, ENCLOSURES, ANTENNAS, ETC.** FAILURE TO PROPERLY AND COMPLETELY ASSEMBLE, INSTALL, OPERATE, USE, AND MAINTAIN TRIPODS, TOWERS, AND ATTACHMENTS, AND FAILURE TO HEED WARNINGS, INCREASES THE RISK OF DEATH, ACCIDENT, SERIOUS INJURY, PROPERTY DAMAGE, AND PRODUCT FAILURE. TAKE ALL REASONABLE PRECAUTIONS TO AVOID THESE HAZARDS. CHECK WITH YOUR ORGANIZATION'S SAFETY COORDINATOR (OR POLICY) FOR PROCEDURES AND REQUIRED PROTECTIVE EQUIPMENT PRIOR TO PERFORMING ANY WORK.

Use tripods, towers, and attachments to tripods and towers only for purposes for which they are designed. Do not exceed design limits. Be familiar and comply with all instructions provided in product manuals. Manuals are available at www.campbellsci.com. You are responsible for conformance with governing codes and regulations, including safety regulations, and the integrity and location of structures or land to which towers, tripods, and any attachments are attached. Installation sites should be evaluated and approved by a qualified engineer. If questions or concerns arise regarding installation, use, or maintenance of tripods, towers, attachments, or electrical connections, consult with a licensed and qualified engineer or electrician.

General

- Protect from over-voltage.
- Protect electrical equipment from water.
- Protect from electrostatic discharge (ESD).
- Protect from lightning.
- Prior to performing site or installation work, obtain required approvals and permits. Comply with all governing structure-height regulations.
- Use only qualified personnel for installation, use, and maintenance of tripods and towers, and any attachments to tripods and towers. The use of licensed and qualified contractors is highly recommended.
- Read all applicable instructions carefully and understand procedures thoroughly before beginning work.
- Wear a **hardhat** and **eye protection**, and take **other appropriate safety precautions** while working on or around tripods and towers.
- **Do not climb** tripods or towers at any time, and prohibit climbing by other persons. Take reasonable precautions to secure tripod and tower sites from trespassers.
- Use only manufacturer recommended parts, materials, and tools.

Utility and Electrical

- **You can be killed** or sustain serious bodily injury if the tripod, tower, or attachments you are installing, constructing, using, or maintaining, or a tool, stake, or anchor, come in **contact with overhead or underground utility lines**.
- Maintain a distance of at least one-and-one-half times structure height, 6 meters (20 feet), or the distance required by applicable law, **whichever is greater**, between overhead utility lines and the structure (tripod, tower, attachments, or tools).
- Prior to performing site or installation work, inform all utility companies and have all underground utilities marked.
- Comply with all electrical codes. Electrical equipment and related grounding devices should be installed by a licensed and qualified electrician.
- Only use power sources approved for use in the country of installation to power Campbell Scientific devices.

Elevated Work and Weather

- Exercise extreme caution when performing elevated work.
- Use appropriate equipment and safety practices.
- During installation and maintenance, keep tower and tripod sites clear of un-trained or non-essential personnel. Take precautions to prevent elevated tools and objects from dropping.
- Do not perform any work in inclement weather, including wind, rain, snow, lightning, etc.

Maintenance

- Periodically (at least yearly) check for wear and damage, including corrosion, stress cracks, frayed cables, loose cable clamps, cable tightness, etc. and take necessary corrective actions.
- Periodically (at least yearly) check electrical ground connections.

Internal Battery

- Be aware of fire, explosion, and severe-burn hazards.
- Misuse or improper installation of the internal lithium battery can cause severe injury.
- Do not recharge, disassemble, heat above 100 °C (212 °F), solder directly to the cell, incinerate, or expose contents to water. Dispose of spent batteries properly.

WHILE EVERY ATTEMPT IS MADE TO EMBODY THE HIGHEST DEGREE OF SAFETY IN ALL CAMPBELL SCIENTIFIC PRODUCTS, THE CUSTOMER ASSUMES ALL RISK FROM ANY INJURY RESULTING FROM IMPROPER INSTALLATION, USE, OR MAINTENANCE OF TRIPODS, TOWERS, OR ATTACHMENTS TO TRIPODS AND TOWERS SUCH AS SENSORS, CROSSARMS, ENCLOSURES, ANTENNAS, ETC.



Global Sales & Support Network

A worldwide network to help meet your needs



Campbell Scientific Regional Offices

Australia

Location: Garbutt, QLD Australia
Phone: 61.7.4401.7700
Email: info@campbellsci.com.au
Website: www.campbellsci.com.au

Brazil

Location: São Paulo, SP Brazil
Phone: 11.3732.3399
Email: vendas@campbellsci.com.br
Website: www.campbellsci.com.br

Canada

Location: Edmonton, AB Canada
Phone: 780.454.2505
Email: dataloggers@campbellsci.ca
Website: www.campbellsci.ca

China

Location: Beijing, P. R. China
Phone: 86.10.6561.0080
Email: info@campbellsci.com.cn
Website: www.campbellsci.com.cn

Costa Rica

Location: San Pedro, Costa Rica
Phone: 506.2280.1564
Email: info@campbellsci.com
Website: www.campbellsci.com

France

Location: Vincennes, France
Phone: 0033.0.1.56.45.15.20
Email: info@campbellsci.fr
Website: www.campbellsci.fr

Germany

Location: Bremen, Germany
Phone: 49.0.421.460974.0
Email: info@campbellsci.de
Website: www.campbellsci.de

India

Location: New Delhi, DL India
Phone: 91.11.46500481.482
Email: info@campbellsci.in
Website: www.campbellsci.in

South Africa

Location: Stellenbosch, South Africa
Phone: 27.21.8809960
Email: sales@campbellsci.co.za
Website: www.campbellsci.co.za

Spain

Location: Barcelona, Spain
Phone: 34.93.2323938
Email: info@campbellsci.es
Website: www.campbellsci.es

Thailand

Location: Bangkok, Thailand
Phone: 66.2.719.3399
Email: info@campbellsci.asia
Website: www.campbellsci.asia

UK

Location: Shepshed, Loughborough, UK
Phone: 44.0.1509.601141
Email: sales@campbellsci.co.uk
Website: www.campbellsci.co.uk

USA

Location: Logan, UT USA
Phone: 435.227.9120
Email: info@campbellsci.com
Website: www.campbellsci.com