

**CR500 DATALOGGER
OPERATOR'S MANUAL**

11/96

COPYRIGHT (c) 1996 CAMPBELL SCIENTIFIC, INC.

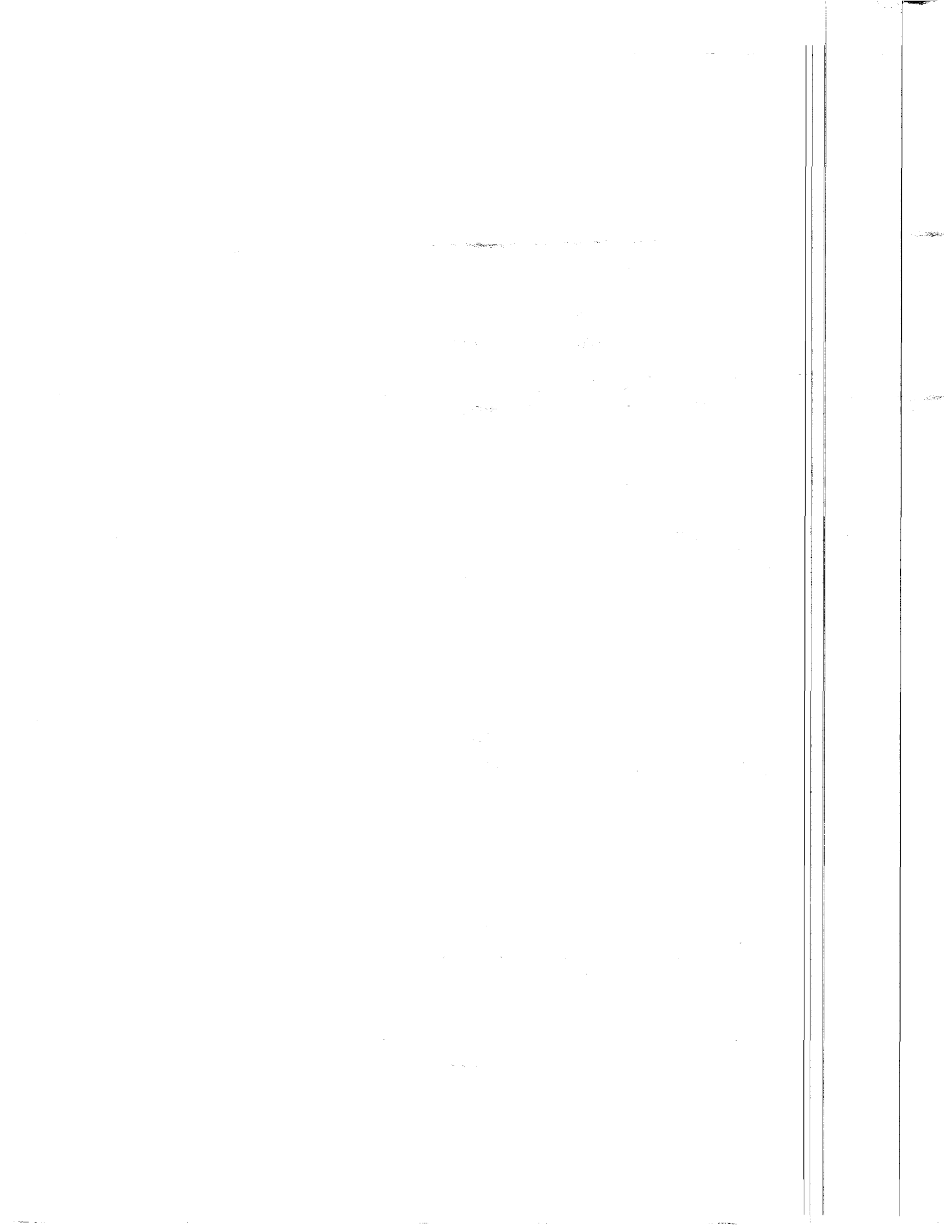

LICENSE FOR USE

This software is protected by both the United States copyright law and international copyright treaty provisions. You may copy it onto a computer to be used and you may make archival copies of the software for the sole purpose of backing-up CAMPBELL SCIENTIFIC, INC. software and protecting your investment from loss. All copyright notices and labeling must be left intact.

This software may be used by any number of people, and may be freely moved from one computer location to another, so long as there is no possibility of it being used at one location while it's being used at another. The software, under the terms of this license, cannot be used by two different people in two different places at the same time.



CAMPBELL SCIENTIFIC, INC.

815 W. 1800 N.
Logan, UT 84321-1784
USA
Phone (435) 753-2342
FAX (435) 750-9540
www.campbellsci.com

Campbell Scientific Canada Corp.
11564 - 149th Street
Edmonton, Alberta T5M 1W7
CANADA
Phone (403) 454-2505
FAX (403) 454-2655

Campbell Scientific Ltd.
14-20 Field Street
Shepshed, Leics. LE12 9AL
ENGLAND
Phone (44)-50960-1141
FAX (44)-50960-1091

LIMITED WARRANTY

CAMPBELL SCIENTIFIC, INC. warrants that the magnetic diskette on which the accompanying computer software is recorded and the documentation provided with it are free from physical defects in materials and workmanship under normal use. CAMPBELL SCIENTIFIC, INC. warrants that the computer software itself will perform substantially in accordance with the specifications set forth in the Operator's Manual published by CAMPBELL SCIENTIFIC, INC. CAMPBELL SCIENTIFIC, INC. warrants that the software is compatible with IBM PC/XT/AT and PS/2 microcomputers and 100% compatible computers only. CAMPBELL SCIENTIFIC, INC. is not responsible for incompatibility of this software running under any operating system other than those specified in accompanying data sheets or operator's manuals.

The above warranties are made for ninety (90) days from the date of original shipment.

CAMPBELL SCIENTIFIC, INC. will replace any magnetic diskette or documentation which proves defective in materials or workmanship without charge.

CAMPBELL SCIENTIFIC, INC. will either replace or correct any software that does not perform substantially according to the specifications set forth in the Operator's Manual with a corrected copy of the software or corrective code. In the case of significant error in the documentation, CAMPBELL SCIENTIFIC, INC. will correct errors in the documentation without charge by providing addenda or substitute pages.

If CAMPBELL SCIENTIFIC, INC. is unable to replace defective documentation or a defective diskette, or if CAMPBELL SCIENTIFIC, INC. is unable to provide corrected software or corrected documentation within a reasonable time, CAMPBELL SCIENTIFIC, INC. will either replace the software with a functionally similar program or refund the purchase price paid for the software.

CAMPBELL SCIENTIFIC, INC. does not warrant that the software will meet licensee's requirements of that the software or documentation are error free or that the operation of the software will be uninterrupted. The warranty does not cover any diskette or documentation which has been damaged or abused. The software warranty does not cover any software which has been altered or changed in any way by anyone other than CAMPBELL SCIENTIFIC, INC. CAMPBELL SCIENTIFIC, INC. is not responsible for problems caused by computer hardware, computer operating systems or the use of CAMPBELL SCIENTIFIC, INC.'s software with non-CAMPBELL SCIENTIFIC, INC. software.

ALL WARRANTIES OF MERCHANTABILITY AND FITNESS FOR A PARTICULAR PURPOSE ARE DISCLAIMED AND EXCLUDED. CAMPBELL SCIENTIFIC, INC. SHALL NOT IN ANY CASE BE LIABLE FOR SPECIAL, INCIDENTAL, CONSEQUENTIAL, INDIRECT, OR OTHER SIMILAR DAMAGES EVEN IF CAMPBELL SCIENTIFIC HAS BEEN ADVISED OF THE POSSIBILITY OF SUCH DAMAGES.

CAMPBELL SCIENTIFIC, INC. is not responsible for any costs incurred as result of lost profits or revenue, loss of use of the software, loss of data, cost of re-creating lost data, the cost of any substitute program, claims by any party other than licensee, or for other similar costs.

LICENSEE'S SOLE AND EXCLUSIVE REMEDY IS SET FORTH IN THIS LIMITED WARRANTY. CAMPBELL SCIENTIFIC, INC.'S AGGREGATE LIABILITY ARISING FROM OR RELATING TO THIS AGREEMENT OR THE SOFTWARE OR DOCUMENTATION (REGARDLESS OF THE FORM OF ACTION - E.G. CONTRACT, TORT, COMPUTER MALPRACTICE, FRAUD AND/OR OTHERWISE) IS LIMITED TO THE PURCHASE PRICE PAID BY THE LICENSEE.

CR500 Specifications

Electrical specifications are valid over a -25° to +50°C range unless otherwise specified.

PROGRAM EXECUTION RATE

System tasks initiated in sync with real-time up to 8 Hz. One measurement with data transfer is possible at this rate without interruption.

ANALOG INPUTS

NUMBER OF CHANNELS: 2 differential or up to 4 single-ended. Each differential channel can be configured as two single-ended channels.

RANGE AND RESOLUTION: Ranges are software selectable for any channel. The resolution for differential measurements is better than single-ended measurements because two measurements are averaged together.

Full Scale Input Range (mV)	Resolution (μ V)	
	Differential	Single-Ended
± 2500	333	666
± 250	33.3	66.6
± 25	3.33	6.66
± 7.5	1.00	2.00
± 2.5	0.33	0.66

ACCURACY OF VOLTAGE MEASUREMENTS AND ANALOG OUTPUT VOLTAGES: $\pm 0.1\%$ of FSR; $\pm 0.05\%$ of FSR, (0 to 40°C); (e.g., $\pm 0.1\%$ FSR = ± 5.0 mV for ± 2500 mV range)

INPUT SAMPLE RATES: The fast and slow A/D conversions use signal integration times of 0.25 and 2.72 ms, respectively.

Fast differential voltage:	4.2 ms
Slow differential voltage:	9.2 ms
Differential with 60 Hz rejection:	25.9 ms

INPUT NOISE VOLTAGE (for ± 2.5 mV range):

Fast differential:	0.82 μ V RMS
Slow differential:	0.25 μ V RMS
Differential with 60 Hz rejection:	0.18 μ V RMS

COMMON MODE RANGE: ± 2.5 V.

DC COMMON MODE REJECTION: > 140 dB.

NORMAL MODE REJECTION: 70 dB (60 Hz with slow differential measurement).

INPUT CURRENT: ± 9 nA maximum.

INPUT RESISTANCE: 20 Gohms typical.

EXCITATION OUTPUTS

DESCRIPTION: 2 switched excitations, active during measurement, with one output active at a time. Non-active outputs are high impedance.

RANGE: ± 2.5 V

RESOLUTION: 0.67 mV

ACCURACY: ± 2.5 mV (0° to 40°C);
 ± 5 mV (-25° to +50°C)

OUTPUT CURRENT: ± 25 mA

FREQUENCY SWEEP FUNCTION: A swept frequency, square wave output between 0 and 2.5 volts is provided for vibrating wire transducers. Timing and frequency range are specified by the instruction.

RESISTANCE AND CONDUCTIVITY MEASUREMENTS

MEASUREMENT TYPES: Using either of the 2 switched excitation channels, the CR500 can measure resistance and conductivity by means of ratio-metric bridge measurements. Standard bridge measurements include 6-wire and 4-wire full bridge, 4-wire, 3-wire, and 2-wire half bridge. Where appropriate, dual polarity bridge measurements are used to eliminate DC errors. AC resistance measurements use a dual polarity

0.75 ms excitation pulse for ionic depolarization; signal integration occurs over the last 0.25 ms.

ACCURACY: $\pm 0.02\%$ of full scale input range used, limited by the matching bridge resistors (e.g., $\pm 0.02\%$ of ± 250 mV full-scale input range = ± 100 μ V). The excitation voltage should be programmed so the bridge output matches the full scale input voltage range.

PERIOD AVERAGING MEASUREMENTS

DEFINITION: The time period for a specified number of cycles of an input signal is measured, then divided by the number of cycles to obtain the average period of a single cycle. Improved timing resolution and noise reduction can be obtained by averaging over many cycles.

INPUTS: Any of the 4 single-ended analog input channels can be selected for period averaging. Signal amplitude reduction or AC coupling is normally required.

INPUT FREQUENCY RANGE:

Range Code	Min volts (peak-peak) @ Max. Freq.*	Max. Input Frequency
1	2 mV	8 kHz
2	5 mV	20 kHz
3	12 mV	40 kHz
4	2000 mV	150 kHz

*AC voltage must be centered around CR500 ground.

RESOLUTION: 35 ns divided by the number of cycles measured.

ACCURACY: $\pm 0.01\%$ of reading + RESOLUTION.

TIME REQUIRED FOR MEASUREMENT: Signal period multiplied by the number of cycles measured plus 1.5 cycles.

PULSE COUNTERS

NUMBER OF PULSE COUNTER CHANNELS: 2 eight-bit or 1 sixteen-bit; software selectable as switch closure, high frequency pulse, or low-level AC. An additional channel (C2/P3) can be software configured to read switch closures at rates up to 40 Hz.

MAXIMUM COUNT RATE: 16 kHz, eight-bit counter; 250 kHz, sixteen-bit counter. Channels are scanned at 8 or 64 Hz (software selectable).

MODES: Switch closure, high frequency pulse, and low level AC.

SWITCH CLOSURE MODE

Minimum Switch Closed Time: 5 ms.
Minimum Switch Open Time: 6 ms.
Maximum Bounce Time: 1 ms open without being counted.

HIGH FREQUENCY PULSE MODE

Minimum Pulse Width: 1 μ s.
Maximum Input Frequency: 500 kHz.
Voltage Thresholds: Count upon transition from below 1.5 V to above 3.5 V.
Maximum Input Voltage: ± 20 V.

LOW LEVEL AC MODE

(Typical of magnetic pulse flow transducers or other low voltage, sine wave outputs.)

Input Hysteresis: 8 mV.
Maximum AC Input Voltage: 20 V RMS.
Minimum AC Input Voltage Range (Hz)
(sine wave mV RMS)*

20	1 to 1000
200	0.5 to 10,000
1000	0.3 to 20,000

*16-bit config. or 64 Hz scan req'd. for freq. > 2048 Hz.

DIGITAL I/O PORTS

2 ports: Port C1 is software selectable as a binary input or control output. Port C2/P3 is input only and can be software configured as an SDI-12 port, a binary input, or as a switch closure counter (40 Hz max).

OUTPUT VOLTAGES (no load): high 5.0 V ± 0.1 V;
low < 0.1 V.

OUTPUT RESISTANCE: 500 ohms.

INPUT STATE: high 3.0 V to 5.5 V; low -0.5 V to 0.8 V.

INPUT RESISTANCE: 100 kohms.

SDI-12 INTERFACE STANDARD

This communication protocol, developed for micro-processor-based hydrologic and environmental sensors, is standard in the CR500.

SENSOR CONNECTIONS: Digital I/O Port C1 or C2 (for asynchronous communication), 12V power, and ground. Up to ten SDI-12 sensors can be connected to each CR500 digital port.

EMI and ESD PROTECTION

Emissions: Meets or exceeds the following standards.

Radiated: per EN 55022:1987 Class B

Conducted: per EN 55022:1987 Class B

Immunity: Meets or exceeds the following standards.

ESD: per IEC 801-2;1984 8kV air discharge

RF: per IEC 801-3;1984 3V/m, 27-500 MHz

EFT: per IEC 801-4; 1988 1kV mains, 500V other

CPU AND INTERFACE

PROCESSOR: Hitachi 6303.

MEMORY: 128 K Flash and 32 K SRAM standard.

DISPLAY: 8 digit LCD (0.5" digits).

PERIPHERAL INTERFACE: 9 pin D-type connector for keyboard display, storage module, modem, printer, card storage module, and RS-232 adapter. Baud rates selectable at 300, 1200, 9600 and 76,800. ASCII communication protocol is one start bit, one stop bit, eight data bits (no parity).

CLOCK ACCURACY: ± 1 minute per month.

SYSTEM POWER REQUIREMENTS

VOLTAGE: 9.6 to 16 volts.

TYPICAL CURRENT DRAIN: 1 mA quiescent,
13 mA during processing, and 46 mA during analog measurement.

BATTERIES: Any 12 volt battery can be connected as a primary power source. Several power supply options are available from Campbell Scientific.

PHYSICAL SPECIFICATIONS

SIZE: 8.4" x 1.5" x 3.9" - Additional clearance required for CSI serial I/O and sensor leads.

WEIGHT: 15 oz.

WARRANTY

Three years against defects in materials and workmanship.



SELECTED OPERATING DETAILS

Starting Date and Time

1. Date and time are stored with each output array.

Data Transfer

2. Short Cut automatically programs the CR500 to dump stored data to a CSI SM192 or SM716 storage module. To output data to a printer requires the technical manual and a program change in EDLOG.

Erase Final Storage Data

3. In the third window of the *A Mode, enter any number and A (see Sec. 7.5.1).

Complete CR500 Reset, Including the Real Time Clock

4. In the fifth window in the *A Mode, enter 98765 and A.

Stop Logging Data

5. Key: *4 99 A 0 A

This changes the scan rate to 0 and stops execution of the datalogger program. The program, any stored data, and the clock setting remains.

To Start Logging Again

6. Key: *4 99 A [new scan rate in seconds] A



CAUTIONARY NOTES

1. To prevent corrosion in the CR500, desiccant must be placed inside the enclosure. To reduce vapor transfer into the enclosure, plug the cable entry seals. DO NOT totally seal enclosures equipped with lead acid batteries. Hydrogen concentration may build up to explosive levels.
2. Damage will occur to the analog input circuitry if voltages in excess of ± 16 V are applied for a sustained period. Voltages in excess of ± 5 V will cause errors and possible overranging on other analog input channels.
3. When using the CR500 with the PS12LA, remember that the sealed lead acid batteries can be permanently damaged if deep discharged routinely or left in a discharged state for a long period of time. The cells are rated at a 7 Ahr capacity but experience a slow discharge even in storage. It is advisable to maintain a continuous charge on the PS12LA battery pack, whether in operation or storage.
4. To make it easier to connect power to the CR500 remove the green connector on the terminal strip. Connect 12 V and G in the proper positions and plug the connector back into its receptacle.
5. When connecting power to the CR500 with the green connector in place, first connect the positive lead from the power source to the 12 V terminal. Then connect the negative lead to G. Connecting these leads in the reverse order makes it easier for the positive wire to accidentally touch a grounded component and short out the power supply.
6. Voltages in excess of 5.5 volts applied to a control port can cause the CR500 to malfunction. Voltages in excess of 8 VDC can cause damage.
7. Voltages in excess of 7 VDC applied to the 5 V port will damage the CR500.
8. Voltage pulses can be counted by CR500 Pulse Counters configured for High Frequency Pulses. However, when the pulse is actually a low frequency signal (below about 10 Hz) AND the positive voltage excursion exceeds 5.6 VDC, the 5 VDC supply will start to rise, upsetting all analog measurements.

Pulses whose positive voltage portion exceed 5.6 VDC with a duration longer than 100 milliseconds need external conditioning. See below.

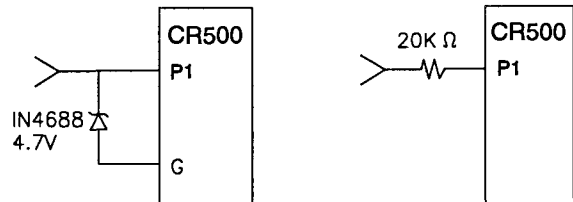
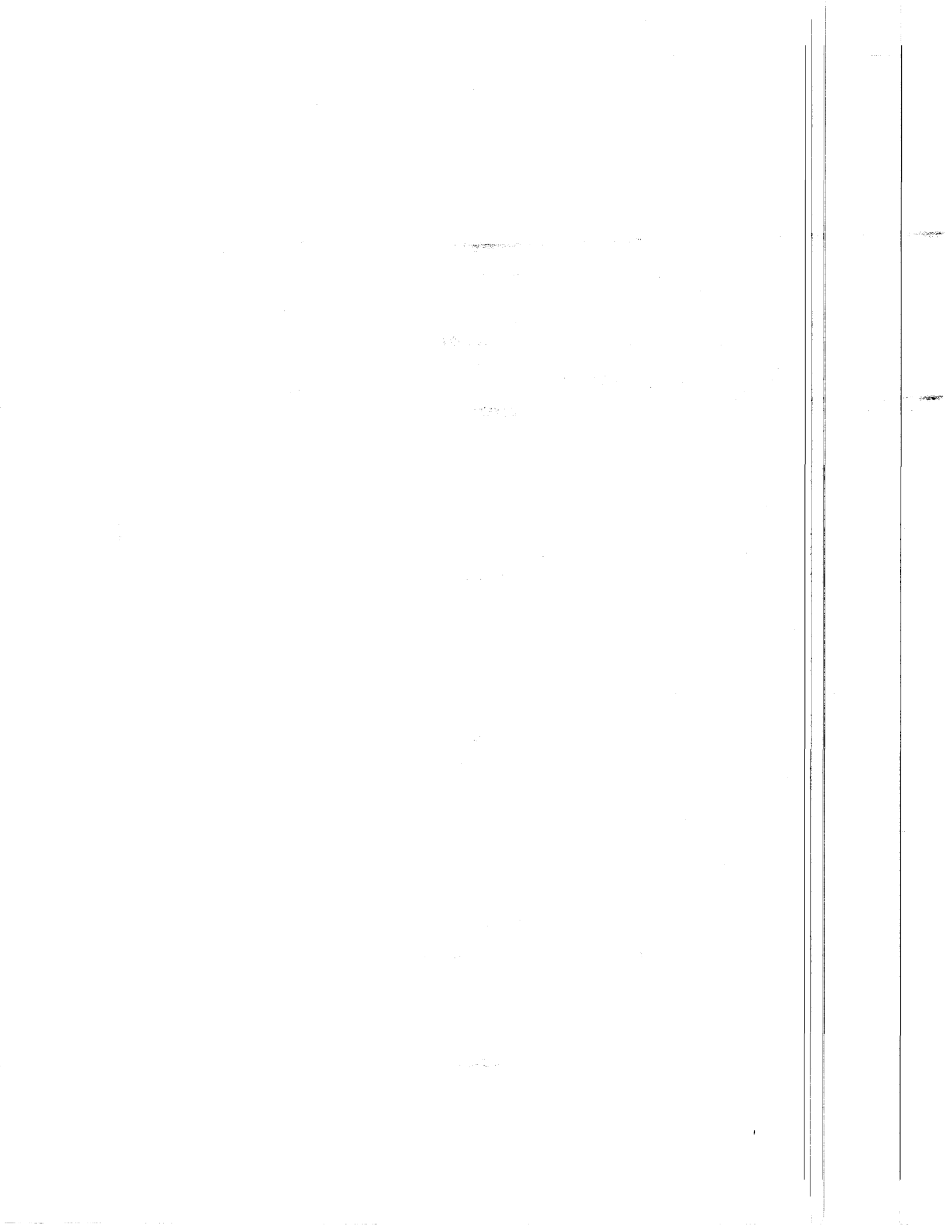

FIGURE. Conditioning for Long Duration Voltage Pulses



CR500

1. Introduction

1.1 Configuration

Required Items for a Complete System

- CR500
- PC500 - CR500 Support Software (includes Short Cut, a "point and click" program builder)
- Operator's Manual
- 12 VDC power supply
CSI options: BPALK or PS12LA
- sealed enclosure
CSI options: ENC 10/12 or CSI part number (P.N.) 6447 with 3 cable entry seals and a sealable vent to atmosphere. Other options include ENC 12/14 and ENC 16/18.
- Interface for user access. Either the CR10KD or PC/laptop with the SC32A optically isolated RS232 interface and a 9 to 25 pin cable (P.N. 7026). When using a battery-powered laptop computer the SC929 cable can be used in place of the SC32A and P.N. 7026.

Option

- PC208 or PC208W Support Software
Supports telecommunications to retrieve data, monitor measurements, set the clock, etc.

2. Hardware

2.1 CR500

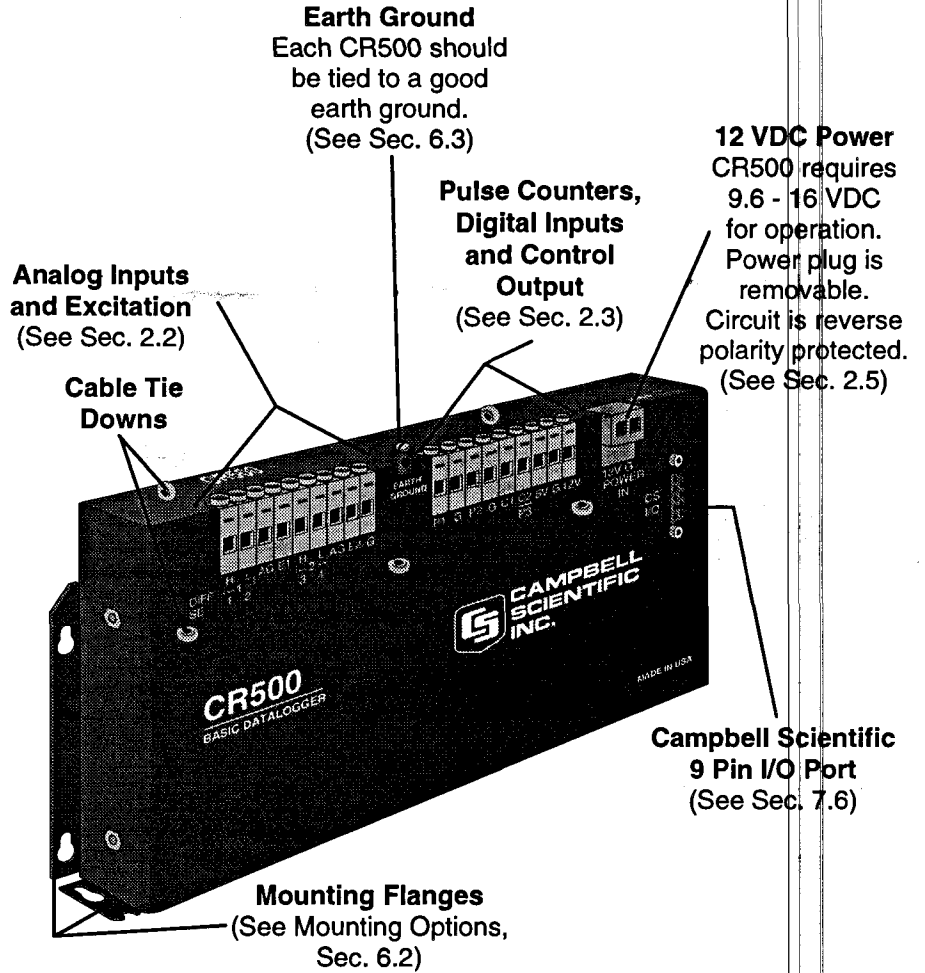

Earth Ground
Each CR500 should be tied to a good earth ground. (See Sec. 6.3)

12 VDC Power
CR500 requires 9.6 - 16 VDC for operation. Power plug is removable. Circuit is reverse polarity protected. (See Sec. 2.5)

Pulse Counters, Digital Inputs and Control Output
(See Sec. 2.3)

Analog Inputs and Excitation
(See Sec. 2.2)

Cable Tie Downs

Campbell Scientific 9 Pin I/O Port
(See Sec. 7.6)

Mounting Flanges
(See Mounting Options, Sec. 6.2)

2.2 Analog Inputs and Excitation

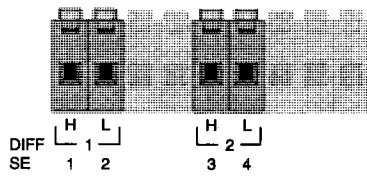

Analog Inputs: Terminals SE 1, 2, 3, and 4 (labeled in light blue) are single-ended input channels. In a single-ended measurement, the voltage on an analog input is measured with respect to analog ground (AG).

When wired and programmed for a differential measurement, SE 1 and 2 are DIFF 1H and 1L. Inputs SE 3 and 4 are DIFF 2H and 2L (labeled in white). In a differential measurement, the voltage on the H (high) input is measured with respect to the voltage on the L (low) input.

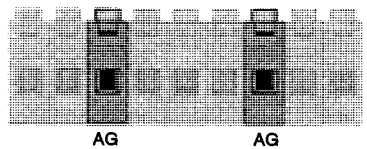

Analog ground: Reference for single-ended measurements and excitation return.

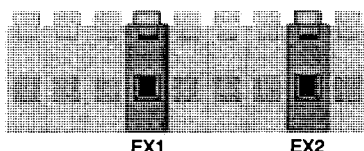

Excitation channels: Provide a precision, programmable switched voltage for sensors that require excitation. Range: $\pm 0 - 2.5$ VDC.



Power ground: Connect cable shields to this ground to minimize electrical noise and protect against voltage transients. The main grounding lug, labeled "earth ground", must be tied to earth ground. Also used as excitation return for some sensors.

2.3 Pulse Counters, Digital Inputs, and Control Output

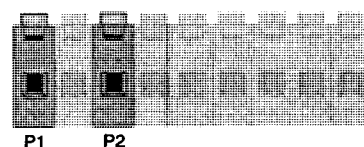

Pulse Counters: To measure switch closures and voltage pulse type sensors. P1 and P2 are programmable for switch closure, voltage pulse, or low level AC signals (see spec sheet on page i). C2/P3 can be programmed to count switch closures at a rate up to 40 Hz (see below).

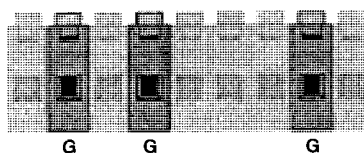

Power Ground: Use as ground reference for pulse counters, binary inputs, SDI-12 inputs, 12 VDC or 5 VDC outputs. Ground terminal for cable shields to minimize electrical noise on sensor inputs and protect against voltage transients. The main grounding lug, labeled "earth ground", must be tied to the earth ground.

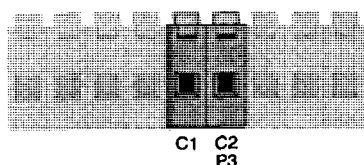

Digital I/O Ports:

Port C1: When configured as **input** can be programmed as an SDI-12 communication line or to read the status of a line.

When configured as **output** can be set high (5 VDC) or low (0 VDC) according to time or a condition. Typically this port can be used to activate an external device (e.g., a sampler) through a relay.

Port C2/P3: Dual function controlled by CR500 program.

C2: Input only. - SDI-12 communication line or monitoring the status of a line.

P3: Port can be programmed to count switch closures up to 40 Hz. Example: tipping bucket rain gauge.

CR500



5 VDC: Provides power for external devices. Example: provide 5 V to a tipping bucket rain gauge being read by port P3.

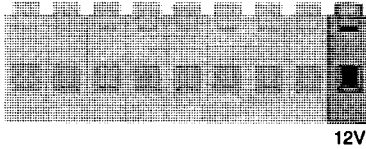

12 VDC: Provides 12 V for SDI-12 communication or for external devices.

2.4 Communicating with the CR500

An external device must be connected to the CR500's CS I/O port to communicate with the CR500. This may be either Campbell Scientific's CR10KD Keyboard Display, a computer/terminal, or one of several Campbell Scientific modems/interfaces.

CR10KD

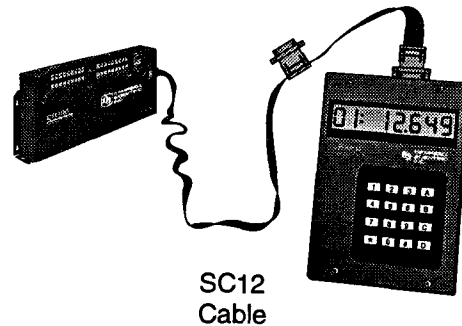

The CR10KD is used to verify field operation, display incoming measurements (*6 mode), view or set the clock (*5 mode), view or set *4 values, display final storage values (*7 mode) and view status and diagnostics in the *A and *B modes (Sec. 5). Programming is done in Short Cut (Sec. 4.3). The program is then downloaded to the CR500 through a PC to CR500 link as shown below.

The CR10KD is powered by the CR500 and connects directly to the 9-pin serial I/O port via the SC12 cable (supplied with the CR10KD). No interfacing software is required.

PC or Laptop

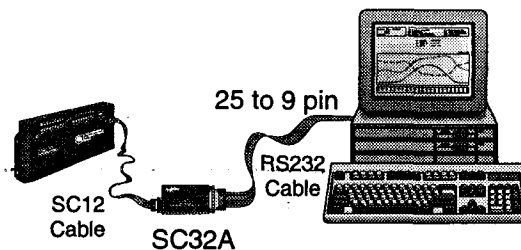

Computer to CR500 communication is accomplished using either Campbell Scientific's PC500 or PC208(W) support software packages. PC500 requires a direct link (SC32A or SC929), while PC208 and PC208W accommodate all CSI telecommunication interfaces (phone, radio; cellular, etc.). Connect the RS232 cable to the PC's serial port (usually a male 9 pin connector).

2.5 CR500 Power Requirement

The CR500 operates at 12 VDC (nominal). Below 9.6 or above 16 VDC, the CR500 will not operate properly. See Section 6.5 for details.

3. Internal Memory

The standard CR500 has 32K of SRAM and 128K of non-volatile Flash EEPROM.

32K SRAM

Used for running datalogger programs.

128K Flash Memory

The Flash memory stores the operating system, user programs, and final storage data.

Breakdown of Flash memory:

- 48K for operating system and datalogger program instruction set.
- 16K for storage of both active and standby user programs. Several programs can be stored and later recalled using the *D mode. See Section 7.5.4.
- 64K for final storage data. Four 16K sectors. Data are written to memory one reading at a time. When memory is full, the 16K sector with the oldest data is completely erased. Then new data is stored in that sector.

Maximum Data Storage

When all three sectors are full, the CR500 will have over 32,000 readings.

When the next reading must be stored, the oldest 16K sector is erased and then the reading is stored. At that point, the CR500 will have just over 24,000 readings in final storage.

For more information on the CR500 memory, see Section 7.2.

4. Software and Programming

4.1 PC500 Support Software

Mouse driven DOS program that supports basic CR500-to-PC operations including program generation, monitoring of real-time measurements, data retrieval over a direct link, and simple report table generation. For operation without a mouse, use the ALT key to activate the menu bar. Telecommunications requires PC208 or PC208W.

Install PC500 and Short Cut

You have two diskettes: PC500 and Short Cut. Place the PC500 diskette in the A: drive slot and change to the A: drive. At the DOS prompt type "install" and press <Enter>. The installation program will take you through the process including asking for the Short Cut diskette when needed. It will also create a PC500 directory.

Start PC500

Type "PC500" at the DOS prompt and press <Enter>. After the program loads you will see the main PC500 screen and menu. (Click OK to remove the note.)

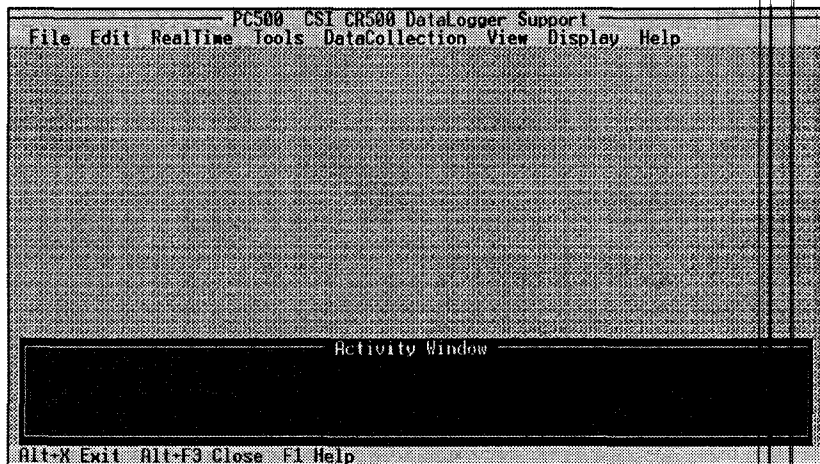

4.2 Building a Program

Using Short Cut, you can select sensors and measurements, choose output data, create wiring diagrams, and prepare reports. Please refer to sensor manuals for installation and maintenance instructions.

Starting Short Cut

In the PC500 menu, choose File. In the File menu, Short Cut. We will abbreviate these directions from here on, e.g., FileShort Cut.

Creating the CR500 Program

Short Cut leads you through four easy steps.

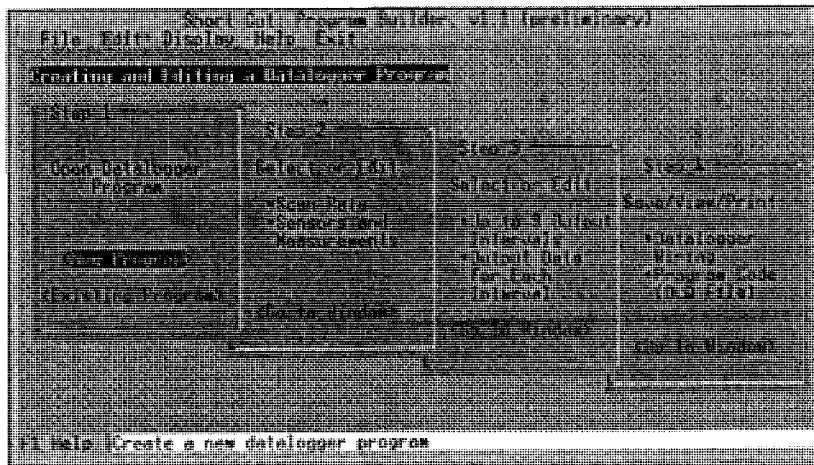

Step 1

Open a new or existing program by selecting one of the options. For a new program, use a name that can be used for the station/logger as well. The site name often works well. Short Cut will use this name for the program it creates. Select OK to go on.

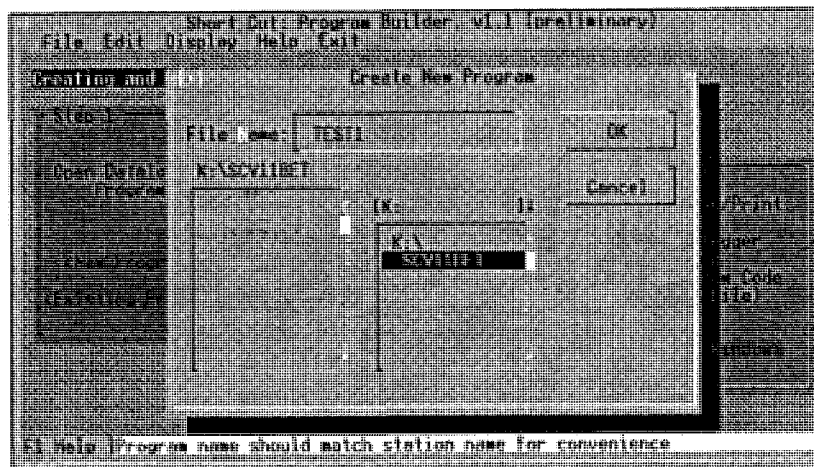

Two files are needed for each site. One will be the CR500 program created by Short Cut. The other, the station file (Sec. 4.3) contains the information PC500 requires to communicate with an individual CR500 at a specific site. Use the same name (ideally the site name) for both the program and the station file.

Select the CR500 as the datalogger type, and click OK to go on.

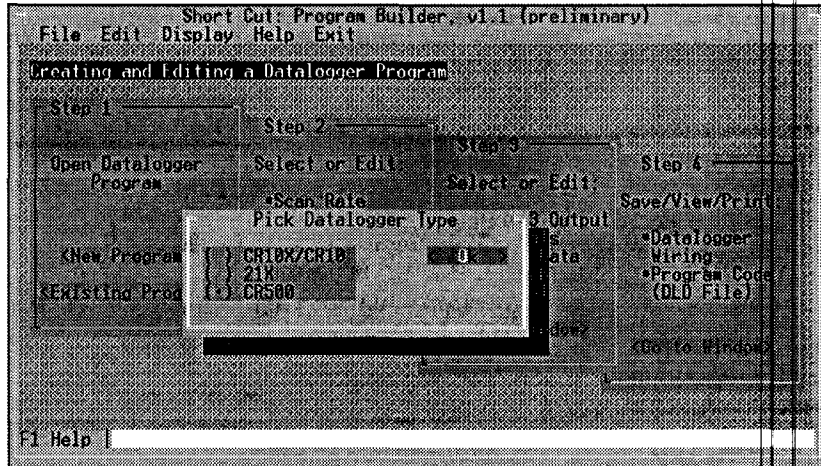

Step 2

In the main screen click on <Go to Window> in Step 2 to see this screen:

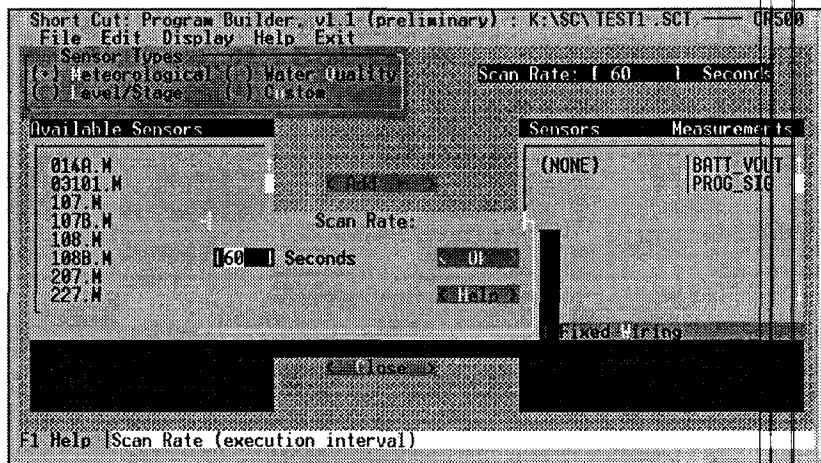

Select the scan rate and click OK. Next, the sensor type: Meteorological, Level/Stage, Water Quality or Custom.

Then highlight a sensor and click add to select.

In this example, the 107B has been selected from the group of water quality sensors. A sensor information screen appears.

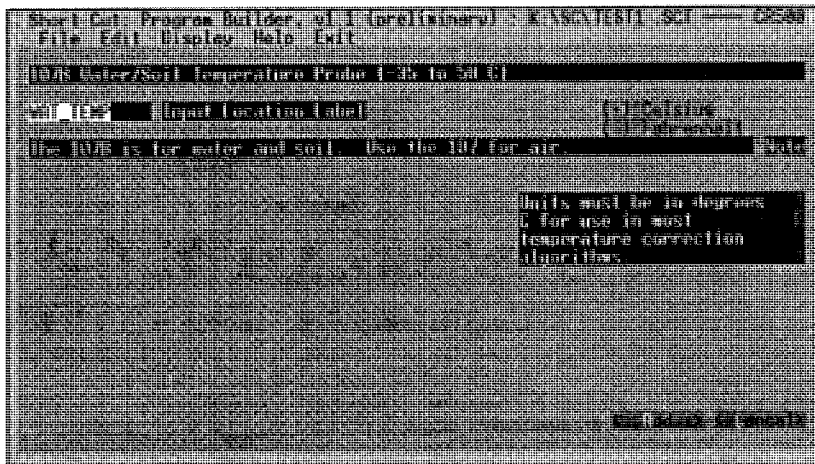

For most sensors you must furnish some configuration information. Short Cut will prompt you for the required information. In this case, the user has selected an output in degrees Celsius.

After this selection the 107B can be added to the list of sensors/measurements for this program. Click **Add**. If you wish to measure other sensors, repeat the process.

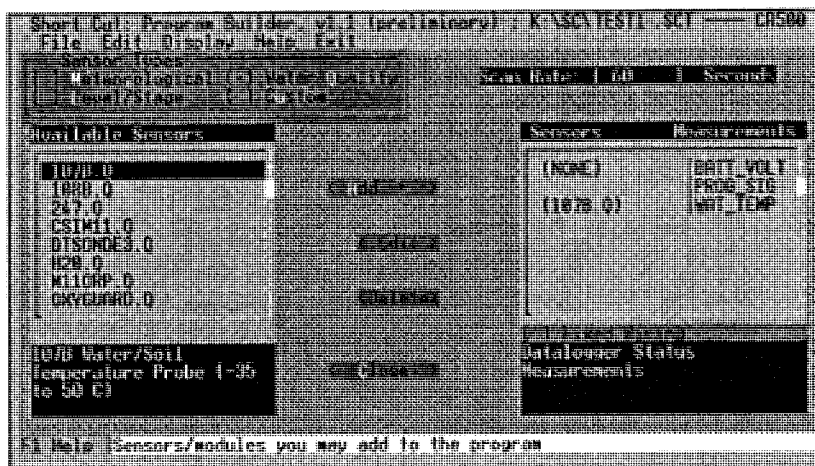

Step 3

After selecting all of your sensors, click Close. Then on the main screen select <Go to Window> in Step 3 to see the following screen:

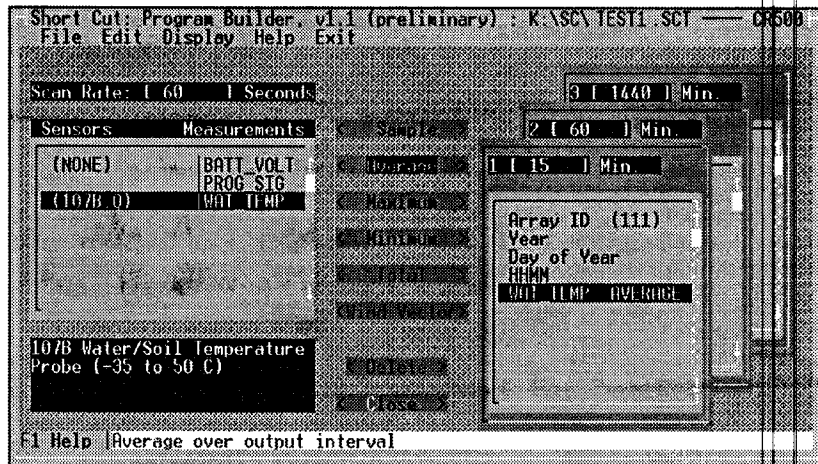

Select Intervals and Output Data. Select the processing and the data output for your application.

You may specify up to three output reports and output intervals. First select the output report you want to work with among the three cascaded windows. The hot keys are Alt-1, Alt-2, and Alt-3. Change the output interval, if desired. Next, select a sensor/measurement from the list on the left followed by the type of processing desired (e.g., sample, average, etc.) from the buttons in the middle of the screen. The output labels will appear in the report window as they are added.

The data output for each interval starts with an array (report) ID number and a time stamp. If you do not add measurements to a report, the report will be disabled.

In this example a 15 minute average of the water temperatures measured every 60 seconds has been selected. Click Close when done.

NOTE: It is prudent to output battery voltage and program signature once a day (see Output Table 3).

Step 4

Select <Go to Window> in Step 4.

Save the program and view or print wiring diagrams, data labels for monitoring, the *4 table (see Sec. 6.9), and list output data.

Use the check boxes on the right screen to select the information you wish to view. All of this information can be printed by selecting **Print**.

Ground Connections

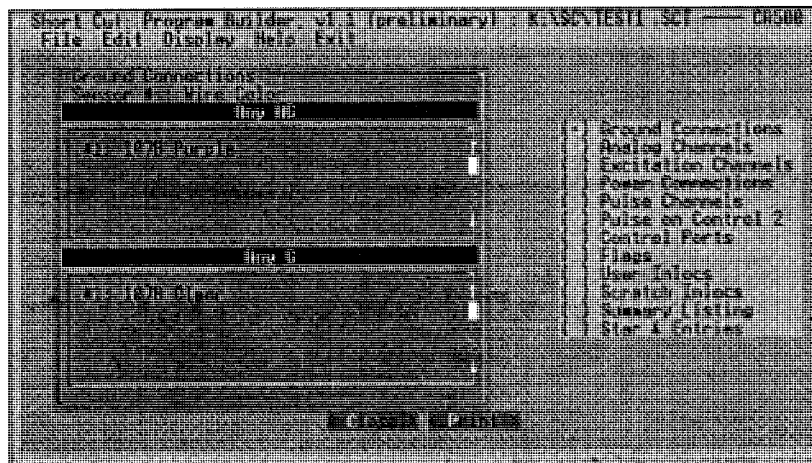

Analog Channels and Wiring Connections

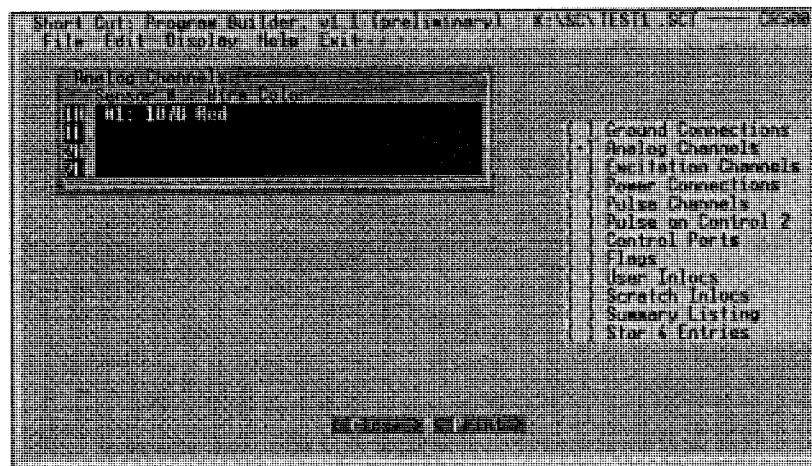

Excitation Channels and Wiring Connections

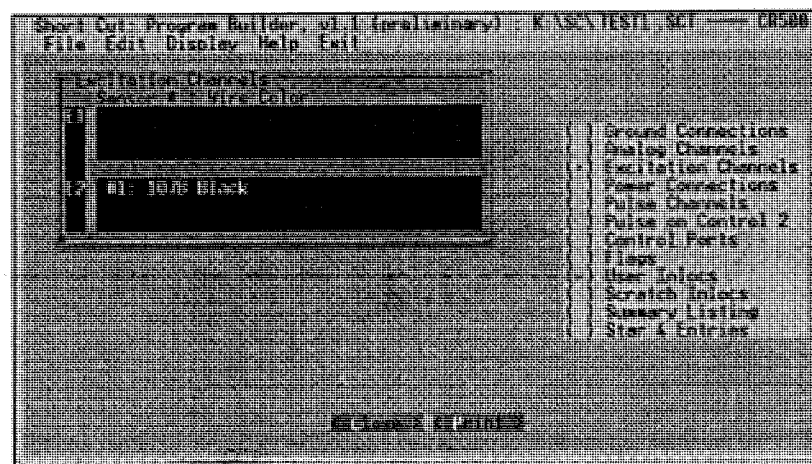

When done, select Close then Exit.

4.3 Create a Station File

After creating a CR500 program, the next step is to create a station file. A station file contains the information PC500 requires (e.g., station name, COM port on your PC, the communications interface, and baud rate) to communicate with a specific CR500. When using PC500 the interface type is the SC32A. There are several other interface options when using PC208 or PC208W for telecommunications.

Select **File|New|Station** to see this screen:

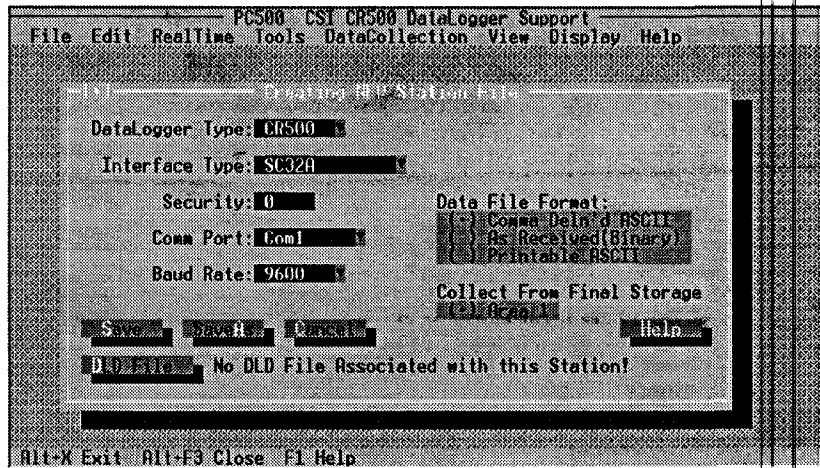

In most cases you can accept all the default settings. However, you may have to choose a different COM port to match your PC. Select the .DLD file (the program created by Short Cut) to associate with the station. When station parameters have been set, select "Save".

You will see this screen:

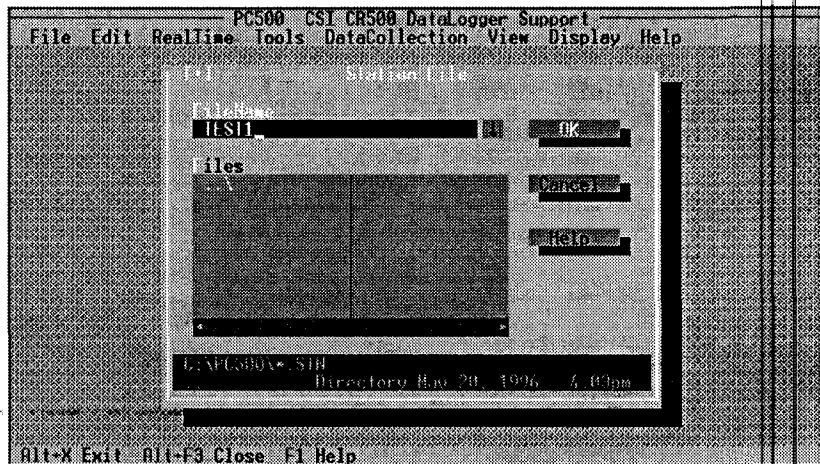

Use the same name for the station file as that chosen for program in Short Cut (eight characters maximum). Select OK.

5. Dry Run

Before going into the field, go through a practice setup in the office.

5.1 Build a Program

Use Short Cut to generate a CR500 program, called a .DLD file. Use a name for the program that can also be used to identify the site (Sec. 4.2).

5.2 Create a Station File

Using PC500, create a station file (.STN) to identify the site and the CR500. Use the same name you used for the program (Sec. 4.3).

5.3 Wire the Sensors and Make PC Connections

Wire the sensors to the CR500 using the wiring diagram created by Short Cut (Sec. 6.4.2).

Connect the CR500 to the computer's serial port. For a PC, use the SC32A. For a battery-powered laptop, use either the SC32A or the SC929.

5.4 Power the CR500

WHEN THE WIRING IS COMPLETE, connect the power supply to the CR500, turn the switch on the PS12LA to ON or plug in the white connector on the BPALK (Sec. 6.5). Connect the CR500 to the PC using either the SC929 or SC32A interface.

5.5 Set the CR500 Clock

Select **Tools|Clock Set|Chk** to see this screen:

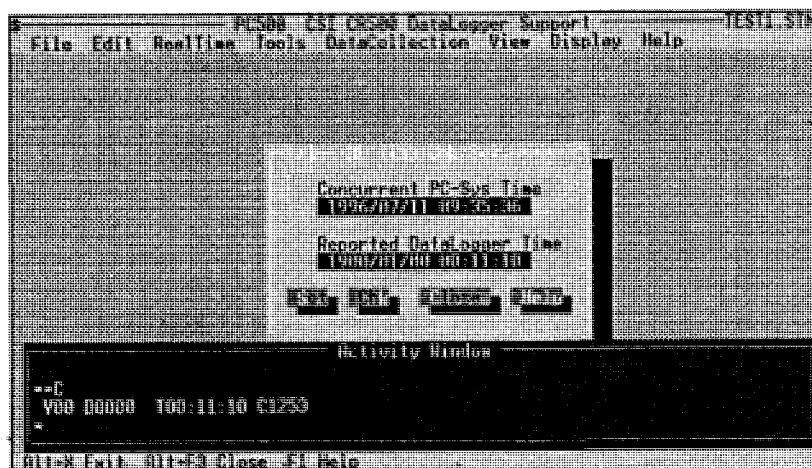

Select **Set**. Then **Close**.

5.6 Load Program (DLD File) Into the CR500

Select **Tools|Send Datalogger Prog.** A pop up warning screen will appear. If there is data you want to save, retrieve it before going ahead (Sec. 5.8). Then select OK.

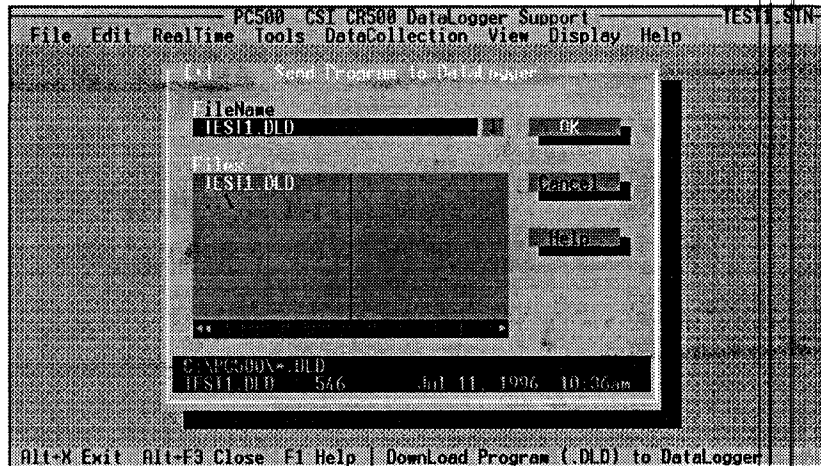

Make sure the correct .DLD file is selected then select OK to download. The program will be sent to the CR500 and begin running, and you will receive a message the download was successful.

5.7 Monitor the Incoming Measurements

From the PC500 menu, select **Realtime|Monitor** to see this screen:

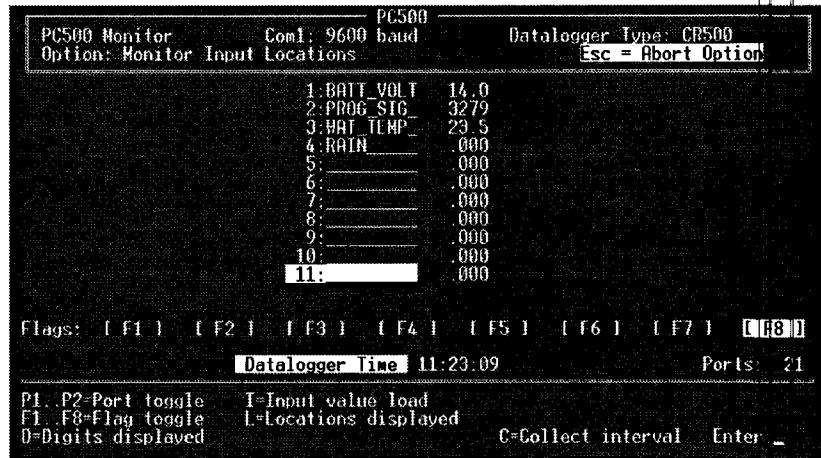

PC500 supports data retrieval through a direct connection with the SC32A or SC929.

NOTE: Several other retrieval options are supported by PC208 and PC208W and will be addressed in those manuals.

When finished, select Escape to return to the PC500 menu.

5.8 Retrieve Data From the CR500

Select **DataCollection/Call Now** to retrieve data. The Activity Window will show the number of locations collected.

5.9 View Data

To view the data that you have retrieved from the CR500, select **View/Data** to see this screen:

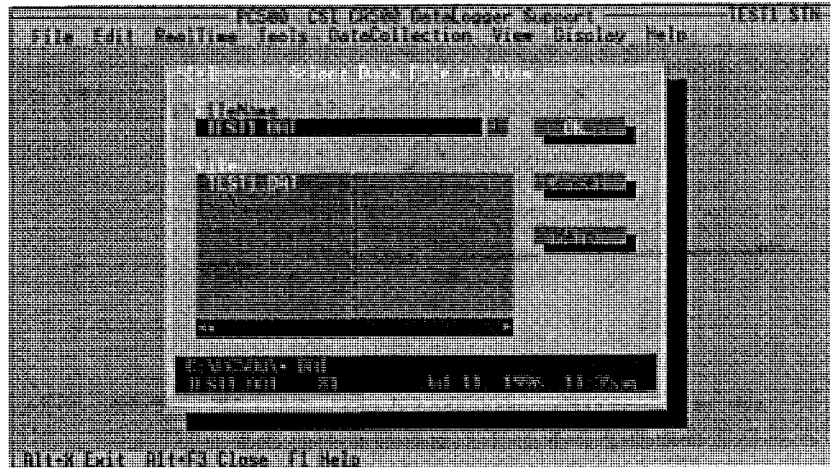

Select or type in the name of the data (.DAT) file you wish to view. Select OK.

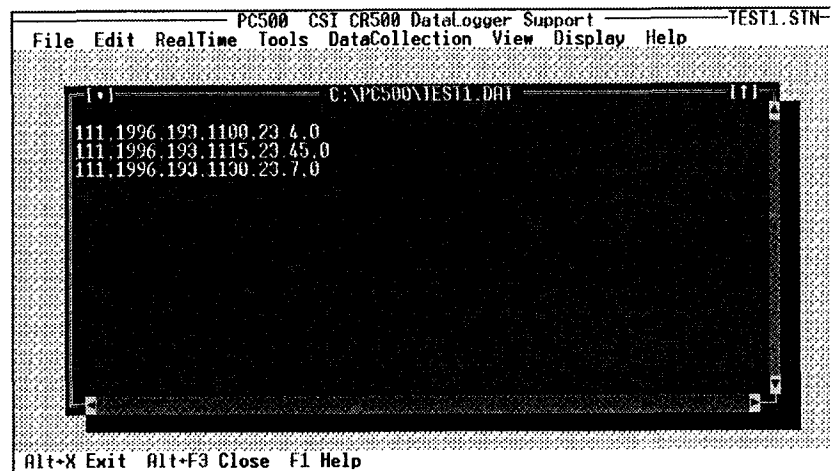

Final storage data are stored in arrays in the CR500. The format of the arrays is:

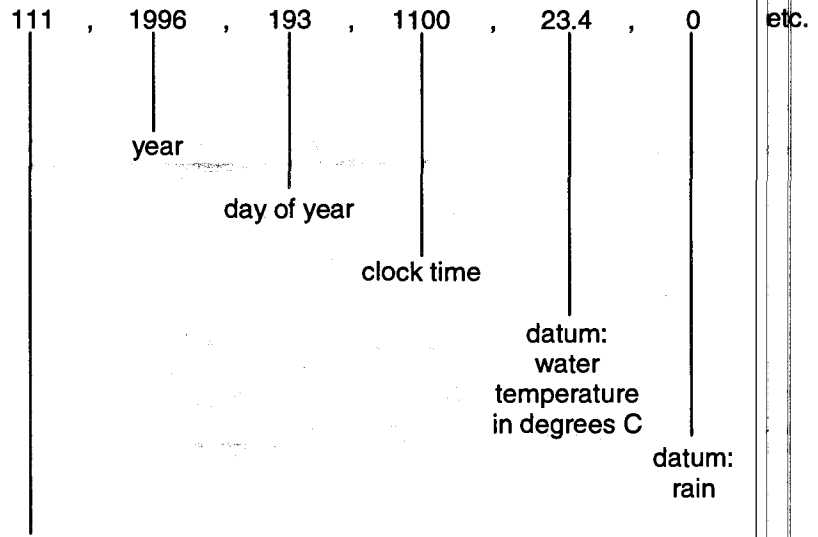

Array ID. Used to identify and segregate arrays stored at different output (time) intervals. Short Cut allows 3 output options and 3 array ID's: 111, 222, and 333.

For more information see Sec. 7.4.

6. Installation and Maintenance

6.1 Installation Check List In the office:

- Create a CR500 program (.DLD) and a station file (.STN). See Sections 4.2 and 4.3.
- Load the program (.DLD file) into the CR500. (This can also be done in the field with a laptop.) See Section 5.6.
- Mount the CR500 and power supply into the enclosure. Do not transport with the batteries installed in the power supply.

NOTE: In Short Cut, Step 4 is a summary list and a list of user input locations. Print these and take them to the field.

In the field:

- Mount the enclosure. Install the battery(ies).
- Install a good earth ground connected to the CR500. See Section 6.3.
- Install the sensors and wire them to the CR500. See Section 6.4.
- Power up the CR500. See Section 6.5.
- Set the CR500 clock. See Section 5.5.

- Verify reasonable measurements are being made and data are being stored. See Sections 5.8 and 5.9.
- Install fresh desiccant in the enclosure and close and latch the door.

6.2 Protection From the Environment

To protect the CR500 from moisture, dirt, insects, etc., use a weatherproof enclosure with desiccant. Examples show CSI P.N. 6447, a 10" x 12" fiberglass enclosure. Several other models are available.

Mounting Options

A. Standard

Note the ground wire (12 or 14 AWG) from ground lug on CR500 to ground lug in enclosure.

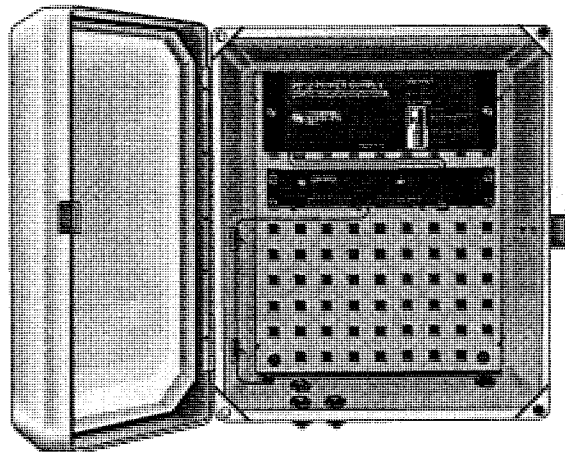

B. Alternate

Note the ground wire (12 or 14 AWG) from ground lug on CR500 to ground lug in enclosure.

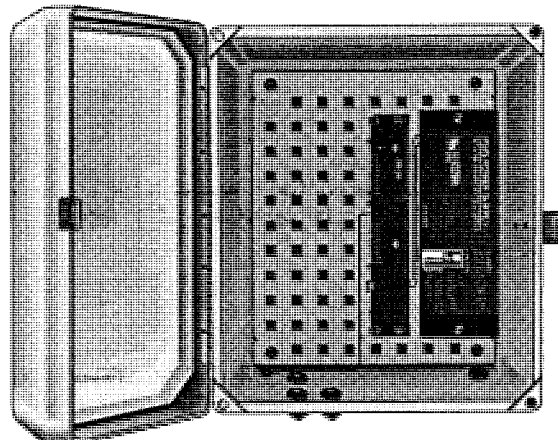

6.3 Grounding

The CR500 MUST be tied to earth ground. It is the user's responsibility to provide this earth ground. The UTGND grounding kit can be purchased from CSI. It includes a lightning rod, grounding rod, cable, and clamps.

All components of a system (datalogger, external power supplies, mounts, housings, etc.) should be referenced to **ONE** common earth ground.

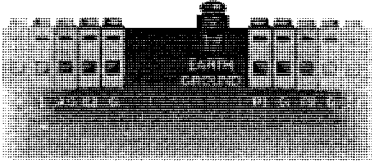

Main grounding lug: Must be tied to earth ground.

Example

Drawing of open enclosure, CR500, power supply and wiring to a good earth ground. A 12 AWG (or larger) wire should be used.

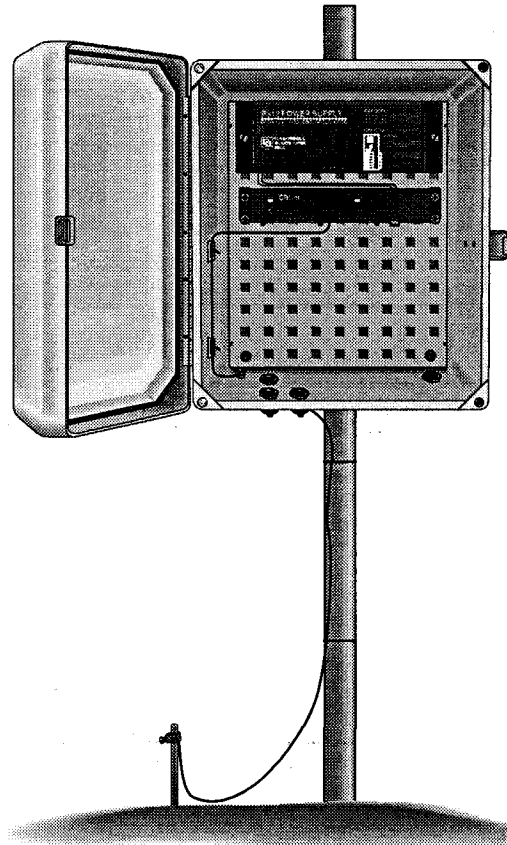

6.4 Wiring

6.4.1 Inserting cables into the enclosure

- Open the cable entry seal on the bottom of the enclosure by turning the squeeze nut (1) counter clockwise.
- Remove and save the plug (2) for further use.
- Insert the wire (3) into the enclosure the required length and then hand tighten the squeeze nut (clockwise).

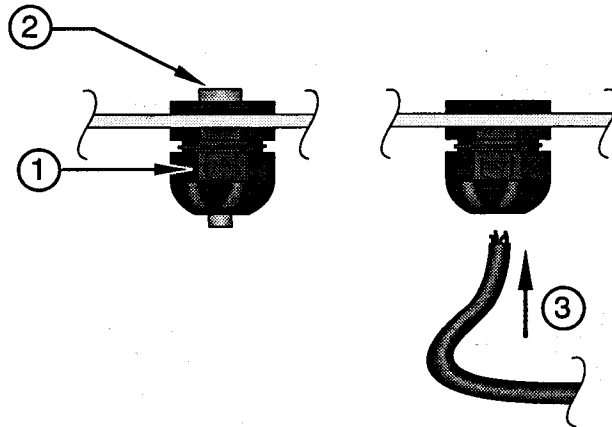

When using enclosures with an open conduit entry hole, insert the wires the required length and seal the hole with the duct putty furnished with the enclosure.

6.4.2 Wiring sensors

Follow the wiring "diagram" created by Short Cut (see Step 4, Section 4.2).

CAUTION: To ensure proper connection do not clamp over the insulation.

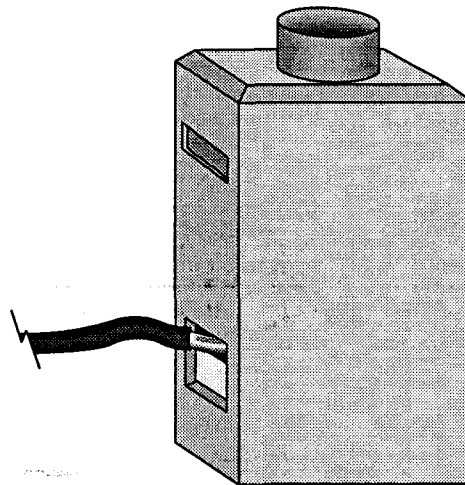

Enlarged view of a single wiring terminal.

CR500

6.5 Powering the CR500

WHEN THE WIRING IS COMPLETE, including proper grounds, turn the switch on the PS12LA to ON or plug in the white connector on the BPALK. Use the CR10KD or a laptop to set the CR500 clock.

Power Supply Options

6.5.1 BPALK

Install the 8 alkaline D cells according to the "map" inside the holder. Place the holder inside being careful to route the connector wire through the notch. Wire 12 V and \oplus to the power plug (12 V and G) on the terminal strip on the CR500.

CAUTION: Connect the white connector ONLY when ready to power the CR500, usually after the sensors have been wired to the CR500.

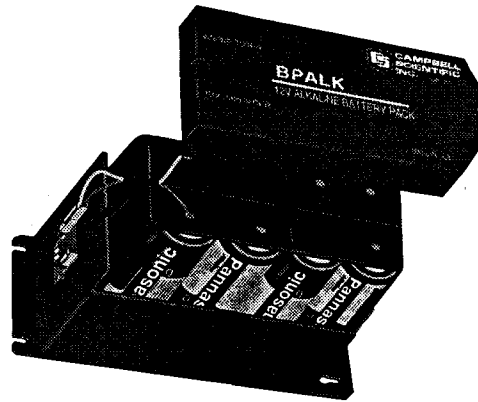

6.5.2 PS12LA

Be sure the PS12LA is being float charged by either the AC adaptor or a solar panel. Turn the switch to OFF. Install the 7 Ahr battery into the case as pictured. Connect the white connector to the receptacle marked INT. Wire 12 V and G (\oplus) to the power plug (12 V and G) on the terminal strip on the CR500.

CAUTION: To prevent damage, do not transport the PS12LA with the battery installed.

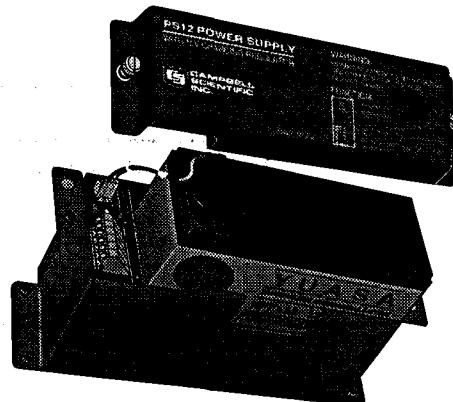

6.6 Setting the Clock in the CR500

Using a PC or Laptop

From the main menu in PC500 select **Tools|Clock Set|Chk**. PC500 will set the CR500 clock to that of the PC or laptop.

Using the CR10KD

Communication between the PC and the CR500 must be terminated before using the keyboard display.

<u>Key In</u>	<u>ID:Data</u>	<u>Explanation</u>
*5	:HH:MM:SS	Displays current time
A	05:xxxx	Displays year
year		
A	05:xxxx	Enter the correct year and then displays the day of the year window.
day of year (see table, Sec. 7.7)		
A	05:HH:MM:SS	Enter the correct day-of-year and displays hours/minutes.
hours & minutes (24 hour clock)		
A	:HH:MM:SS	Enter the correct time (24 hour clock).

6.7 View the Measurements

Using a Laptop

In the PC500 main menu, select **Real Time|Monitor**. When finished, select **Escape**.

Select **Real Time/Hang Up Link**.

Using the CR10KD

Key In: *6 [location #] A

Other keys: A - advance
B - back up

The location is the input location found in the Short Cut list.

When finished, be sure to key in *0.

6.8 View Stored Data

Using the CR10KD

Stored data can be verified in the *7 mode.

Key In: *7 A

- A - advances
- B - backs up
- #A - advances to the same element in the next array
- #B - backs up to the same element in the previous array

See Sections 5.9 and 7.4.

Using a Laptop

First collect the data to a .DAT file. In the PC500 main menu, select **ViewData**.

When finished, select **Real TimeHang Up Link**.

6.9 The *4 Table

The *4 table provides an easy method to change certain values in your CR500 program (DLD file). An example of when this is needed is the setting of an offset in the field at a stream gauging station. Short Cut selects certain values a user might want to change and assigns them to the *4 table. Examples are the calibration multiplier for a pressure transducer or the scan rate (program execution interval). Find the *4 table with its labels by going to Step 4 in Short Cut (for the specific .SCT file) and clicking on "Star 4 Entries".

The *4 table has locations from 0 to 99. Location 99 is reserved for the scan rate.

6.10 To View or Change a Value in the *4 Table

Using the CR10KD

- **To view** a value in the *4 table, key in:

*4 [location number] A

Pressing A advances to next location in the *4 table. Pressing B backs up to the previous location.

When finished, be sure to key in *0 to resume logging.

- **To change** a value in the *4 table, key in:

*4 [location number] A [new value]
A if a positive number, CA if negative

When finished, **be sure to key in *0** to recompile and resume logging.

Using a Laptop

To enter the Remote Keyboard State

- From the menu in PC500 select **RealTime|Call**.
- When you see the "*" in the message box, select **Tools|Terminal Mode**.
- Press the "Enter" key two or three times to see the asterisk returned.
- Key in 7H and "Enter" to receive the ">" prompt. The CR500 is now in the Remote Keyboard State.

To view a *4 value, key in:

*4 [location number] A
A advances, B backs up.

To change a *4 value, key in:

*4 [location number] A [new value]
A if the new value is positive, CA if negative

- When finished, **be sure to key in *0** to recompile and begin logging.
- Select Close to exit Terminal Mode and select **Real Time|Hang Up Link**.

NOTE: In the Terminal Mode, communications will "time out" and stop after 45 seconds in which no key is pressed.

6.11 Changing Batteries in the BPALK

Connect the backup power before disconnecting the main power supply. This will ensure the CR500 clock continues with the correct time. In the event of a power failure the data and the program ARE saved, but the clock is reset to 0.

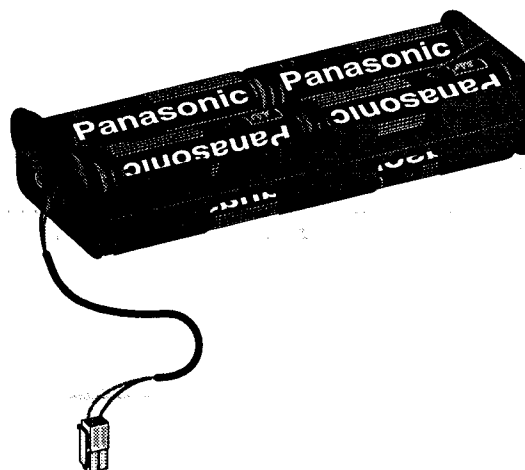

6.12 Troubleshooting

No Response From Datalogger Using CR10KD

- A. Make sure the battery has been installed, and the power switch is "ON".
- B. Use a voltmeter to measure the voltage on the 12 V and G terminals on the datalogger; the voltage must be between 9.6 and 16 VDC.
- C. Disconnect any sensor or peripheral wires connected to the 5 V and 12 V terminals.
- D. Disconnect any communications or storage peripherals from the datalogger.
- E. Reset the datalogger by turning the power switch to "OFF", then to "ON".
- F. If still no response, call Campbell Scientific.

No Response From Datalogger Through SC32A, SC929, or Modem Peripheral

At the datalogger:

- A. Make sure the battery has been installed, and the power switch is "ON" (Section 2.5 and 6.5).
- B. Use a voltmeter to measure the voltage on the 12 V and G terminals on the datalogger; the voltage must be between 9.6 and 16 V DC.
- C. Make sure the datalogger is connected to the modem, and the modem is properly configured and cabled. See appropriate peripheral manual.
- D. Make sure the Station File is configured correctly (Sec. 4.3.).
- E. Check the cable(s) between the serial port and the modem. If cables have not been purchased through Campbell Scientific, check for the following configuration using an ohm meter:

25-pin serial port:

<u>computer end</u>	<u>modem end</u>
2	2
3	3
7	7
20	20

9-pin serial port:

<u>computer end</u>	<u>modem end</u>
2	3
3	2
4	20
5	7

- F. Make sure the modem is properly configured and cabled. See appropriate peripheral manual.
- G. If still no response, call Campbell Scientific.

-99999 Displayed In An Input Location

- A. Make sure the battery voltage is between 9.6 and 16 VDC. Use a voltmeter to measure the voltage between the 12 V and G terminals on the CR500.
- B. Verify the sensor is wired to the analog channel specified in the measurement instruction.
- C. Make sure the Range parameter in the measurement instruction covers the full scale voltage output by the sensor.

**Unreasonable Results
Displayed in an Input
Location**

- A. Inspect the sensor for damage and/or contamination.
- B. Make sure the sensor is properly wired to the datalogger.
- C. Check the multiplier and offset parameters in the measurement instruction.

**6999 or 99999 Stored in
Final Storage (or
Storage Module)**

- A. Final Storage format limitations exceeded (any number larger than 6999 in low resolution, or 99999 in high resolution format is stored as the maximum number). Change the datalogger program.

7. ADDITIONAL INFORMATION

7.1 COMMUNICATING WITH THE CR500

7.1.1 CR10KD KEYBOARD/DISPLAY

The SC12 cable (supplied with the CR10KD) is used to connect the Keyboard/Display to the 9 pin CS I/O port on the CR500.

If the Keyboard/Display is connected to the CR500 upon power up, the "HELLO" message is displayed while the CR500 checks memory. The total size of memory is then displayed (160 for 160 K bytes of memory). When the CR10KD is plugged in after the CR500 has powered up, the display is meaningless until "*" is pressed to enter a mode.

7.1.2 FUNCTIONAL MODES

CR500/User interaction is broken into different functional MODES (e.g., setting time, inserting *4 value, manually initiating a block data transfer to Storage Module, etc.). The modes are referred to as Star (*) Modes since they are accessed by first keying *, then the mode number or letter. Table 7.1-1 lists the CR500 Modes.

TABLE 7.1-1. * Mode Summary

<u>Key</u>	<u>Mode</u>
* 0	LOG data and indicate active Tables
* 1	These are program tables. They are
* 2	NOT typically used since the CR500
* 3	is most often programmed in Short Cut.

NOTE: Altering any value in these program tables and compiling the program will erase the *4 table in the CR500.

* 4	Parameter Entry Table
* 5	Display/set real time clock
* 6	Display/alter Input Storage data, toggle flags or control ports.
* 7	Display Final Storage data
* 8	Final Storage data transfer to peripheral
* A	Memory allocation/reset/erase data
* B	Signature/status
* C	Security
* D	Save/load Program
* #	Used with TGT1 satellite transmitter

7.1.3 KEY DEFINITION

Keys and key sequences have specific functions when using the CR10KD keyboard or a computer/terminal in the remote keyboard state. Table 7.1-2 lists these functions. In some cases, the exact action of a key depends on the mode the CR500 is in and is described with the mode in the manual.

TABLE 7.1-2. Key Description/Editing Functions

<u>Key</u>	<u>Action</u>
0 - 9	Key numeric entries into display
*	Enter Mode (followed by Mode Number)
A	Enter/Advance
B	Back up
C	Change the sign of a number or index an input location to loop counter
D	Enter the decimal point
#	Clear the rightmost digit keyed into the display
# A	Advance to next instruction in program table (*1, *2, *3) or to next Output Array in Final Storage (*7)
# B	Back up to previous instruction in program table or to previous Output Array in Final Storage
# D	Delete entire instruction
# 0	(then A or CR) Back up to the start of the current array.

When using a computer/terminal to communicate with the CR500 (Telecommunications remote keyboard state) there are some keys available in addition to those found on the CR10KD. Table 7.1-3 lists these keys.

TABLE 7.1-3. Additional Keys Allowed in Telecommunications

<u>Key</u>	<u>Action</u>
-	Change Sign, Index (same as C)
CR	Enter/advance (same as A)
:	Colon (used in setting time)
S or ^S	Stops transmission of data (10 second time-out; any character restarts)
C or ^C	Aborts transmission of Data

7.1.4 USING COMPUTER WITH DATALOGGER SUPPORT SOFTWARE

Direct datalogger communication programs in the datalogger support software (PC208E, PC500, TCOM datalogger session) provide a menu selection of tools to perform the datalogger functions (e.g., set clock, send program, monitor measurements, and collect data). The user also has the option of directly entering keyboard commands via a built-in terminal emulator (Section 7.1.5).

When using the support software, the computer's baud rate, port, and modem types are specified and stored in a file for future use.

The simplest and most common interface is the SC32A Optically Isolated RS232 Interface. The SC32A converts and optically isolates the voltages passing between the CR500 and the external terminal device.

The SC12 Two Peripheral cable which comes with the SC32A is used to connect the CS I/O port of the CR500 to the 9 pin port of the SC32A labeled "Datalogger". Connect the "Terminal/Printer" port of the SC32A to the serial port of the computer with a straight 25 pin cable or, if the computer has a 9 pin serial port, a standard 9 to 25 pin adapter cable.

7.1.5 ASCII TERMINAL OR COMPUTER WITH TERMINAL EMULATOR

Devices which can be used to communicate with the CR500 include standard ASCII terminals and computers programmed to function as a terminal emulator.

To communicate with any device other than the CR10KD, the CR500 enters its Telecommunications Mode and responds only to valid telecommunications commands. Within the Telecommunications Mode, there are 2 "states"; the Telecommunications Command state and the Remote Keyboard state. Communication is established in the Telecommunications command state. PC500 uses these commands to accomplish its functions. One of the commands is to enter the Remote Keyboard state.

The Remote Keyboard state allows the keyboard of the computer/terminal to act like the CR10KD keyboard. Various datalogger modes may be entered, including the mode in which programs may be keyed in to the CR500

from the computer/terminal. Entering the remote keyboard state is described in Section 6.10.

7.2 MEMORY AND PROGRAMMING CONCEPTS

7.2.1 INTERNAL MEMORY

The standard CR500 has 128 K of Flash Electrically Erasable Programmable Read Only Memory (EEPROM) and 32 K Static Random Access Memory (SRAM). The Flash EEPROM stores the operating system, user programs, and Final Storage data. RAM is used for running the program. The use of the Input, Intermediate, and Final Storage in the measurement and data processing sequence is shown in Figure 7.2-1. The four areas of SRAM are:

1. **System Memory** - used for overhead tasks such as compiling programs, transferring data, etc. The user cannot access this memory.
2. **Program Memory** - available for user entered programs.
3. **Input Storage** - Input Storage holds the results of measurements or calculations. The *6 Mode is used to view Input Storage locations for checking current sensor readings or calculated values. Input Storage defaults to 28 locations. Additional locations can be assigned using the *A Mode.
4. **Intermediate Storage** - Certain Processing Instructions and most of the Output Processing Instructions maintain intermediate results in Intermediate Storage. Intermediate storage is automatically accessed by the instructions and cannot be accessed by the user. The default allocation is 64 locations. The number of locations can be changed using the *A Mode.

While the total size of Program Memory, Input Storage, and Intermediate Storage remains constant, memory may be reallocated between the areas to accommodate different measurement and processing needs (*A Mode, Section 7.5.1).

Final processed values are stored in Flash EEPROM for transfer to printer, solid state Storage Module or for retrieval via telecommunication links. Values are stored in Final Storage only by the Output Processing

Instructions and only when the Output Flag is set in the user's program. Approximately 24,000 locations are allocated to Final Storage on power up. This number is reduced if Input or Intermediate Storage is increased.

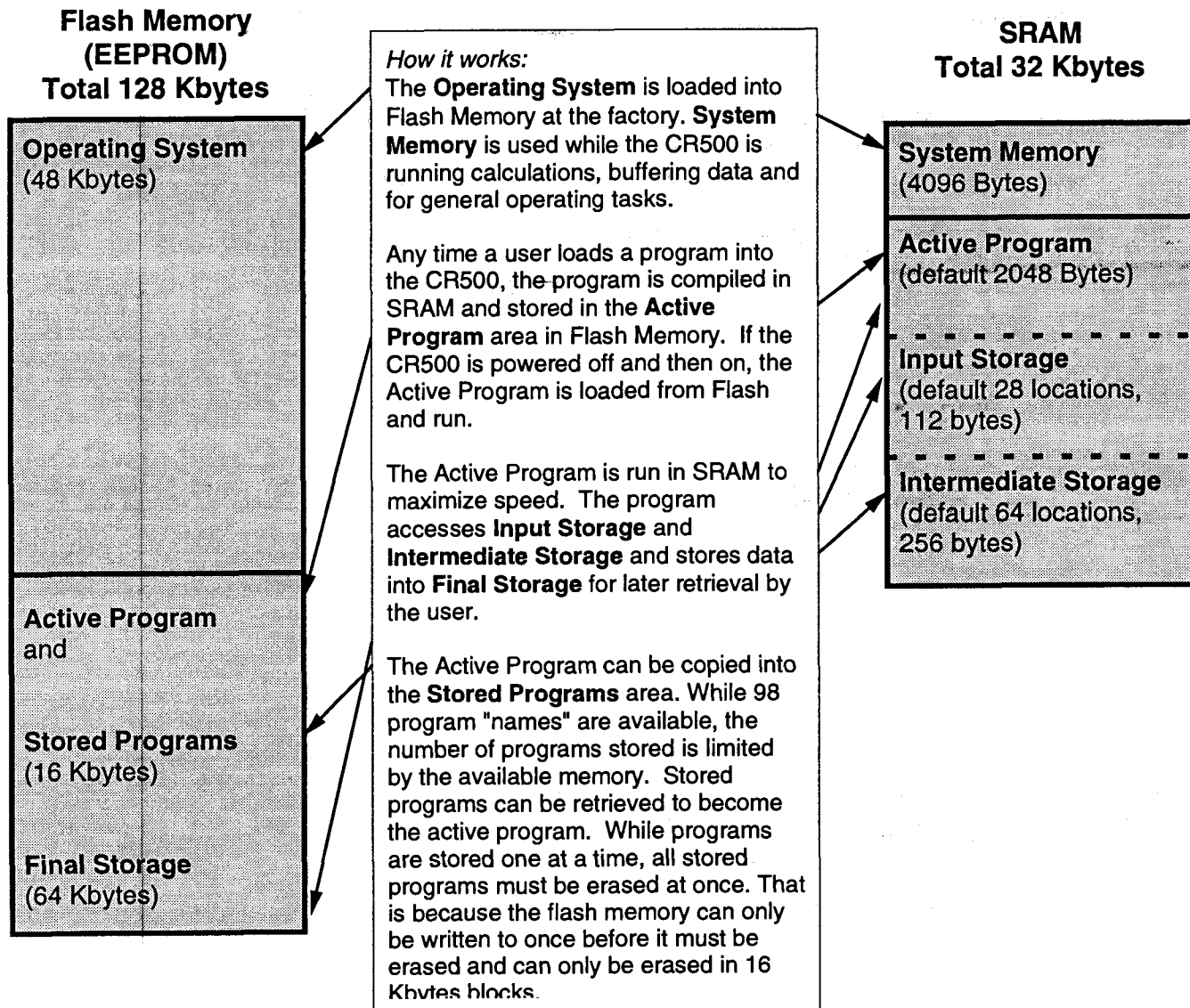

FIGURE 7.2-1. CR500 Memory

7.3 INTERNAL DATA STORAGE

7.3.1 FINAL STORAGE AREAS AND OUTPUT ARRAYS

Final Storage is the memory where final processed data are stored. Final Storage data are transferred to your computer or external storage peripheral.

The size of Final Storage is expressed in terms of memory locations or bytes. A low resolution data point (4 decimal characters) occupies one memory location (2 bytes), whereas a high resolution data point (5 decimal characters) requires two memory locations (4 bytes). Figure 7.2-1 shows the default allocation of memory locations to Program, Input, Intermediate, and Final Storage. The *A Mode is used to reallocate memory or erase Final Storage (Section 7.5.1).

The default size of Final Storage with standard memory is 32,768 low resolution memory locations.

The CR500 stores data in strings of data points called OUTPUT ARRAYS. The first date point in the output array is a 3 digit OUTPUT ARRAY ID.

7.4 DATA OUTPUT FORMAT AND RANGE LIMITS

Data are stored internally in Campbell Scientific's Binary Final Storage Format. Data may be sent to Final Storage in either LOW RESOLUTION or HIGH RESOLUTION format.

7.4.1 RESOLUTION AND RANGE LIMITS

Low resolution data is a 2 byte format with 4 significant digits and a maximum magnitude of +6999. High resolution data is a 4 byte format with 5 significant digits and a maximum possible output value of +99999 (see Table 7.4-1 below).

TABLE 7.4-1. Resolution Range Limits of CR500 Data

<u>Resolution</u>	<u>Zero</u>	<u>Minimum Magnitude</u>	<u>Maximum Magnitude</u>
Low	0.000	+0.001	+6999.
High	0.0000	+ .00001	+99999.

The resolution of the low resolution format is reduced to 3 significant digits when the first (left most) digit is 7 or greater. Thus, it may be

necessary to use high resolution output or an offset to maintain the desired resolution of a measurement. For example, if water level is to be measured and output to the nearest 0.01 ft., the level must be less than 70 ft. for low resolution output to display the 0.01 ft. increment. If the water level was expected to range from 50 to 80 ft. the data could either be output in high resolution or could be offset by 20 ft. (transforming the range to 30 to 50 ft.).

7.4.2 INPUT AND INTERMEDIATE STORAGE DATA FORMAT

While output data have the limits described above, the computations performed in the CR500 are done in floating point arithmetic. In Input and Intermediate Storage, the numbers are stored and processed in a binary format with a 23 bit binary mantissa and a 6 bit binary exponent. The largest and smallest numbers that can be stored and processed are 9×10^{18} and 1×10^{-19} , respectively. The size of the number determines the resolution of the arithmetic. A rough approximation of the resolution is that it is better than 1 in the seventh digit. For example, the resolution of 97,386,924 is better than 10. The resolution of 0.0086731924 is better than 0.00000001.

A precise calculation of the resolution of a number may be determined by representing the number as a mantissa between .5 and 1 multiplied by 2 raised to some integer power. The resolution is the product of that power of 2 and 2^{-24} . For example, representing 478 as .9336 * 2^9 , the resolution is $2^9 * 2^{-24} = 2^{-15} = 0.0000305$.

7.4.3 DISPLAYING STORED DATA ON KEYBOARD/DISPLAY - *7 MODE

(Computer/terminal users refer to Section 6.10 for instructions on entering the Remote Keyboard State.)

Final Storage may be displayed by using the *7 Mode. Key *7. The first window displays the current DSP location. Pressing A advances you to the Output array ID of the oldest Array in the Storage Area. To locate a specific Output Array, enter a location number that positions the Display Pointer (DPTR) behind the desired data and press the "A" key. If the location number entered is in the middle of an Output Array, the DPTR is automatically advanced to the first data point of the next Output Array. Repeated use of the "A" key advances through the Output Array,

while use of the "B" key backs the DPTR through memory.

The memory location of the data point is displayed by pressing the "#" key. At this point, another memory location may be entered, followed by the "A" key to jump to the start of the Output Array equal to or just ahead of the location entered. Whenever a location number is displayed by using the "#" key, the corresponding data point can be displayed by pressing the "C" key.

The same element in the next Output Array with the same ID can be displayed by hitting #A. The same element in the previous array can be displayed by hitting #B. If the element is 1 (Array ID), then #A advances to the next array and #B backs up to the previous array. #0A backs up to the start of the current array.

The keyboard commands used in the *7 Mode are summarized in Table 7.4-2.

Advancing the DPTR past the Data Storage Pointer (DSP) displays the oldest data point. Upon entering the *7 Mode, the oldest Output Array can be accessed by pressing the "A" key.

TABLE 7.4-2. *7 Mode Command Summary

<u>Key</u>	<u>Action</u>
A	Advance to next data point
B	Back-up to previous data point
#	Display location number of currently displayed data point value
C	Display value of current location
# A	Advance to same element in next Output Array with same ID
# B	Back-up to same element in previous Output Array with same ID
# 0 A	Back-up to the start of the current Final Data Storage Array
*	Exit *7 Mode

7.5 FUNCTIONAL MODES

7.5.1 *A MODE

The *A Mode is used to 1) determine or view the number of locations allocated to Input Storage, Intermediate Storage, and Program Memory; 2) repartition this memory; 3) check the number of bytes remaining in Program memory; 4) erase Final Storage; and 5) to completely reset the datalogger.

When *A is entered, the first number displayed is the number of memory locations allocated to Input Storage. The "A" key is used to advance through the next 5 windows. Table 7.5-1 describes what the values in the *A Mode represent.

Memory allocation defaults at reset to the values in Table 7.2-1. The size of Final Storage is determined by the size of memory installed.

The sizes of Input, Intermediate, and Program Memory may be altered by keying in the desired value and entering it by keying "A". One Input or Intermediate Storage location can be exchanged for two Final Storage locations.

TABLE 7.5-1. Description of *A Mode Data

<u>Keyboard Entry</u>	<u>Display ID: Data</u>	<u>Description of Data</u>
* A	01:XXXX	Input Storage Locations - (Minimum of 28, maximum limited by amount of memory allocated for Intermediate Storage Locations and the User Program.) This value can be changed by keying in the desired number.
A	02:XXXX	Intermediate Storage Locations - This is automatically calculated by the program. This does not affect the data in Final Storage.
A	03:X	Final Storage Reset - Entering a number into this window and pressing A will erase all data in Final Storage.
A	04:XXXXX	Final Storage Area Locations - (32,768). User cannot change this window.
A	05:XXXX.X	Bytes Allocated for User Program - The number of bytes to assign to program memory can be keyed in to change the size of program memory. Entering 0 will also result in the CR500 erasing all data whenever the program is changed and compiled. Key in 98765 to completely reset the datalogger, including the datalogger's real time clock.
A	06:XXXX.X	Bytes Free in Program Memory - The user cannot change this window. It is a function of window 5 and the program.

If Intermediate Storage size is too small to accommodate the programs or instructions entered, the "E:04" ERROR CODE will be displayed in the *0, *6, and *B Modes. The user may remove this error code by entering a larger value for Intermediate Storage size. Intermediate Storage and Program Memory can be automatically allocated by entering 0 for their size. The size of Final Storage and the rate at which data are stored determines how long it will take for Final Storage to fill, at which point new data will write over old.

After repartitioning memory, the program must be recompiled. Compiling erases Intermediate Storage. Compiling with *0 erases Input Storage; compiling with *6 leaves Input Storage unaltered.

ENTERING 98765 for the number of bytes to allocate for program memory COMPLETELY RESETS THE CR500. All memory is erased including any stored programs and memory is checked. Memory allocation returns to the default.

7.5.2 MEMORY TESTING AND SYSTEM STATUS - *B

The *B Mode is used to check the status of the program's operating system. Table 7.5-2 describes what the values seen in the *B Mode represent.

A signature is a number which is a function of the data and the sequence of data in memory. It is derived using an algorithm which assures a 99.998% probability that if either the data or its sequence changes, the signature changes. The signature of the program memory is used to determine if the program tables have been altered. During the self check on reset, the signature computed for the OS is compared with a stored signature to determine if a failure has occurred.

The contents of windows 6 and 7, Operating System (OS) version and version revision, are helpful in determining what OS is in the datalogger. As different versions are released, there may be operational differences. When calling Campbell Scientific for datalogger assistance, please have these numbers available.

TABLE 7.5-2. Description of *B Mode Data

<u>Keyboard Entry</u>	<u>Display ID: Data</u>	<u>Description of Data</u>
* B	01: XXXXX	Program memory Signature. The value is dependent upon the programming entered and memory allotment. If the program has not been previously compiled; it will be compiled and run.
A	02: XXXXX	Operating System (OS) Signature
A	03: XXXXX	Memory Size, Kbytes (Flash + SRAM)
A	04: XX	Number of E08 occurrences (Key in 88 to reset)
A	05: XX	Number of overrun occurrences (Key in 88 to reset)
A	06: X.XXXX	Operating System version number
A	07: XXXX.	Version revision number
A	08: X.XXXX	Should be 0
A	09: XX	Should be 0
A	10: XX	Extended memory error counter (Key in 88 to reset)
A	11: X.XXXX	Extended Memory time of erase, seconds

TABLE 7.5-3. *C Mode Entries

SECURITY DISABLED		
<u>Keyboard Entry</u>	<u>Display ID: Data</u>	<u>Description</u>
* C	01:XXXX	Non-zero password blocks entry to *1, *2, *3, *A, and *D Modes.
A	02:XXXX	Non-zero password blocks *4, *5, and *6 except for display.
A	03:XXXX	Non-zero password blocks *5, *6, *7, *8, *9, *B, and all telecommunications commands except A, L, N, and E.
SECURITY ENABLED		
<u>Keyboard Entry</u>	<u>Display ID: Data</u>	<u>Description</u>
* C	12:0000	Enter password. If correct, security is temporarily unlocked through that level.
A	01:XX	Level to which security has been disabled. 0 -- Password 1 entered (everything unlocked) 1 -- Password 2 entered 2 -- Password 3 entered

7.5.3 *C MODE -- SECURITY

The *C Mode is used to block access to the user's program information and certain CR500 functions. There are 3 levels of security, each with its own 4 digit password. Setting a password to a non-zero value "locks" the functions secured at that level. The password must subsequently be entered to temporarily unlock security through that level. Passwords are part of the program. If security is enabled in the active program, it is enabled as soon as the program is run when the CR500 is powered up.

When security is disabled, *C will advance directly to the window containing the first password. A non-zero password must be entered in order to advance to the next window. Leaving a password 0, or entering 0 for the password disables that and subsequent levels of security.

Security may be temporarily disabled by entering a password in the *C Mode. The password entered determines what operations are unlocked (e.g., entering password 2 unlocks the functions secured by passwords 2 and 3). Password 1 (everything unlocked) must be entered before any passwords can be altered.

When security is temporarily disabled in the *C Mode, entering *0 will automatically re-enable security to the level determined by the passwords entered.

7.5.4 *D MODE -- SAVE OR LOAD PROGRAM

The *D Mode is used to save or load CR500 programs, to set the datalogger ID, and to set communication to full or half duplex.

Programs (*1, *2, *3, *4, *A, *C, and *D Mode data) may be stored to and from computers, internal flash memory, and Storage Modules. Several programs can be stored in the CR500 Flash Memory and later recalled and run using the *D Mode or Instruction 111.

When "*D" is keyed in, the CR500 will display "13:00". A command (Table 7.5-4) is entered by keying the command number and "A".

TABLE 7.5-4. *D Mode Commands

<u>Command</u>	<u>Description</u>
1	Send (Print) ASCII Program
2	Load ASCII Program, *0 Compile
2--	Load ASCII Program, *6 Compile
6	Store Program in Flash
7	Load Program from Flash
7N	Save/Load/Clear Program from Storage Module N
8	Set Datalogger ID
9	Set Full/Half Duplex

If the CR500 program has not been compiled when the command to save a program is entered, it will be compiled before the program is saved. When a program is loaded, it is immediately compiled and run. When a command is complete, "13:0000" is displayed; *D must be entered again before another command can be given.

TABLE 7.5-5. Program Load Error Codes

E 94	Program Storage Area full
E 95	Program does not exist in flash
E 96	Storage Module not connected or wrong address
E 97	Data not encountered within 30 sec.
E 98	Uncorrectable errors detected
E 99	Wrong type of file or Editor Error

Internal Flash Program Storage

Several programs can be stored in the CR500 Flash Memory and later recalled and run using the *D Mode. The Flash Electrically Erasable Programmable Read Only Memory is non-volatile memory that can only be erased in 16K blocks. The CR500 has 128K of Flash EEPROM memory, one 16K block is reserved for storing extra programs.

When a program is loaded and compiled, it is saved as the active program. The active program will be automatically loaded and run when the CR500 is powered up. (If a Storage Module with a program 8 is connected when the CR500 powers-up, the Storage Module program 8 will be loaded into the CR500 and become the active program.)

The active program can be stored in internal flash memory program storage with *D command 6 (Table 7.5-6). Programs can be retrieved with *D command 7 (Table 7.5-7).

TABLE 7.5-6. Storing Program in Internal Flash

Key entry	Display
*D	13:00
6A	06:00

You may now enter one of the following options:

xxA	Save active program as number xx, xx may be 1-98.
A	Scroll forward and
B	backward through saved program numbers. The numbers are displayed in the order saved.
99A99A	Clear all saved programs.
0A	Display number of bytes free in saved program area.

TABLE 7.5-7. Retrieving a Program from Internal Flash

Key entry	Display
*D	13:00
7A	07:00

You may now enter one of the following options:

xxA	Retrieve program number xx (the most recent xx saved). To have the program compile like *6 (no resetting of input locations, flags, or ports) press C (xx--) before A.
0A	Erase active program (i.e., load a blank program; memory allocation and Final Storage are reset).
A	Scroll forward and
B	backward through saved program numbers.

Scrolling through the program names begins with the oldest program. "A" advances to the next newer program, "B" backs up to the next older program. While scrolling, at any time typing in a number (xxA) will cause a save or a retrieve operation.

Each program saved takes up the memory required for the program + 6 bytes.

Flash memory can only be written to once before being erased. Because it can only be erased in 16K blocks, if one stored program is to be erased, all must be erased. To allow revising a program and storing it with the same number (name) as an earlier version, the same

number can be used by more than one saved program. When retrieving a program, the programs are searched beginning with the last program saved; the most recently saved version will be retrieved. An older program with a duplicate name cannot be retrieved. When the flash program memory is full, all programs must be erased before any more can be added (error 94 will be displayed).

PROGRAM TRANSFER WITH STORAGE MODULE

Storage Modules can store up to eight separate programs. The Storage Module and Keyboard/Display or Modem/Terminal must both be connected to the CR500. After keying *D, the command 7N, is entered (N is the Storage Module address 1-8). Address 1 will work with any Storage Module address; the CR500 will search for the lowest address Storage Module that is connected. The command to save, load, or clear a program and the program number (Table 7.5-8) is entered. After the operation is finished "13:0000" is displayed. Error 96 indicates that the Storage Module is not connected or the wrong address was given.

TABLE 7.5-8. Transferring a Program using a Storage Module

Key entry	Display
*D	13:00
7NA	7N:00 (N is Storage Module address 1-8)

You may now enter one of the following options:

1x	Save Program x to Storage Module (x = 1-8)
2x	Load Program x from Storage Module (x = 1-8)
3x	Erase Program x in Storage Module (x = 1-8)

The datalogger can be programmed on power-up using a Storage Module. If a program is stored as program number 8, and the Storage Module is connected to the datalogger I/O at power-up, program number 8 is automatically loaded into the active program area of the datalogger and run.

Full/Half Duplex

The *D Mode can also be used to set communications to full or half duplex. The default is full duplex, which works best in most situations.

TABLE 7.5-9. Setting Duplex

Key entry	Display
*D	13:00
9A	09:0x

When finished *0

If x=0 the CR500 is set for full duplex.

If x=1 the CR500 is set for half duplex.

You may now change the option:

0A	Set full duplex
1A	Set half duplex

SET DATALOGGER ID

Command 8 is used to set the datalogger ID. The ID can be moved to an input location with Instruction 117 and can then be sampled as part of the data.

TABLE 7.5-10. Setting Datalogger ID

Key Entry	Display
*D	13:00
8A	08:0XXX

When finished *0

Where XXX are 0s or the current ID. You may now key in the ID (1-254, excluding 13).

7.6 CS I/O PORT PIN DESCRIPTION

All external communication peripherals connect to the CR500 through the 9-pin subminiature D-type socket connector located on the front of the Wiring Panel (Figure 7.6-1). Table 7.6-1 shows the I/O pin configuration, and gives a brief description of the function of each pin.

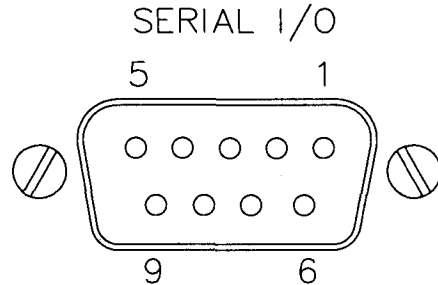

FIGURE 7.6-1. 9-pin Female Connector

TABLE 7.6-1. Pin Description

<u>PIN</u>	<u>ABR</u>	<u>I/O</u>	<u>Description</u>
<p>ABR = Abbreviation for the function name. PIN = Pin number. O = Signal Out of the CR500 to a peripheral. I = Signal Into the CR500 from a peripheral.</p>			
			<p>6 SDE O Synchronous Device Enable: Used to address Synchronous Devices (SDs), and can be used as an enable line for printers.</p>
			<p>7 CLK/HS I/O Clock/Handshake: Used with the SDE and TXD lines to address and transfer data to SDs. When not used as a clock, pin 7 can be used as a handshake line (during printer output, high enables, low disables).</p>
			<p>8 Not used.</p>
			<p>9 TXD O Transmit Data: Serial data are transmitted from the CR500 to peripherals on pin 9; logic low marking (0V) logic high spacing (5V) standard asynchronous ASCII, 8 data bits, no parity, 1 start bit, 1 stop bit, 300, 1200, 9600, 76,800 baud (user selectable).</p>
1	5 V	O	5V: Sources 5 VDC, used to power peripherals.
2	SG		Signal Ground: Provides a power return for pin 1 (5V), and is used as a reference for voltage levels.
3	RING	I	Ring: Raised by a peripheral to put the CR500 in the telecommunications mode.
4	RXD	I	Receive Data: Serial data transmitted by a peripheral are received on pin 4.
5	ME	O	Modem Enable: Raised when the CR500 determines that a modem raised the ring line.

7.7 DAY OF YEAR CALENDAR

	1	2	3	4	5	6	7	8	9	10	11	12	13	14	15	16	17	18	19	20	21	22	23	24	25	26	27	28	29	30	31	
JAN	1	2	3	4	5	6	7	8	9	10	11	12	13	14	15	16	17	18	19	20	21	22	23	24	25	26	27	28	29	30	31	
FEB	32	33	34	35	36	37	38	39	40	41	42	43	44	45	46	47	48	49	50	51	52	53	54	55	56	57	58	59	60			
MAR	60	61	62	63	64	65	66	67	68	69	70	71	72	73	74	75	76	77	78	79	80	81	82	83	84	85	86	87	88	89	90	
APR	91	92	93	94	95	96	97	98	99	100	101	102	103	104	105	106	107	108	109	110	111	112	113	114	115	116	117	118	119	120		
MAY	121	122	123	124	125	126	127	128	129	130	131	132	133	134	135	136	137	138	139	140	141	142	143	144	145	146	147	148	149	150	151	
JUN	152	153	154	155	156	157	158	159	160	161	162	163	164	165	166	167	168	169	170	171	172	173	174	175	176	177	178	179	180	181		
JUL	182	183	184	185	186	187	188	189	190	191	192	193	194	195	196	197	198	199	200	201	202	203	204	205	206	207	208	209	210	211	212	
AUG	213	214	215	216	217	218	219	220	221	222	223	224	225	226	227	228	229	230	231	232	233	234	235	236	237	238	239	240	241	242	243	
SEP	244	245	246	247	248	249	250	251	252	253	254	255	256	257	258	259	260	261	262	263	264	265	266	267	268	269	270	271	272	273		
OCT	274	275	276	277	278	279	280	281	282	283	284	285	286	287	288	289	290	291	292	293	294	295	296	297	298	299	300	301	302	303	304	
NOV	305	306	307	308	309	310	311	312	313	314	315	316	317	318	319	320	321	322	323	324	325	326	327	328	329	330	331	332	333	334		
DEC	335	336	337	338	339	340	341	342	343	344	345	346	347	348	349	350	351	352	353	354	355	356	357	358	359	360	361	362	363	364	365	

Add 1 to unshaded values during leap years.

