

CPEC200

Closed Path
Eddy Covariance System

Quick Deploy Guide



February 2016



**CAMPBELL[®]
SCIENTIFIC**

WHEN MEASUREMENTS MATTER

1. Setup tripod and mount enclosures.

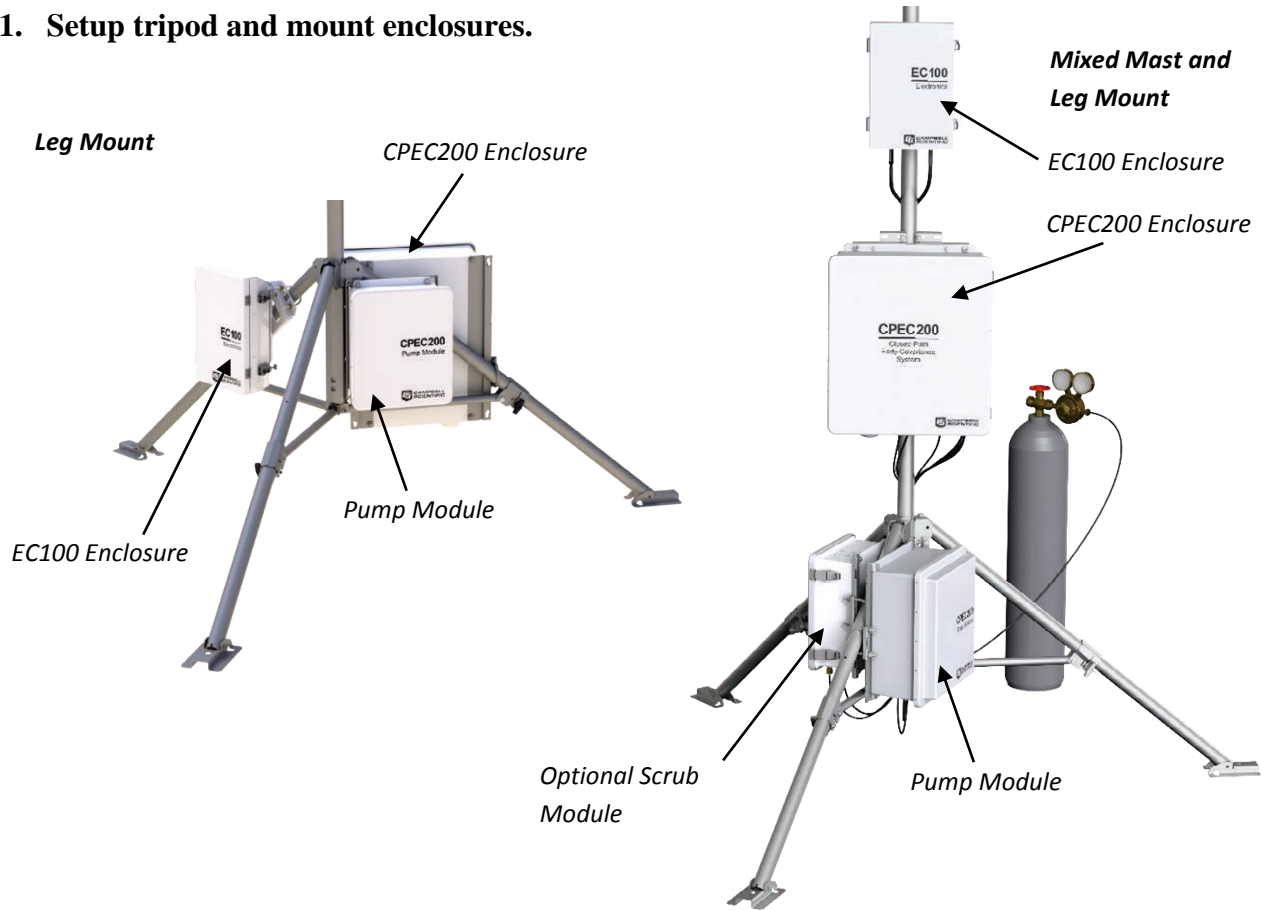

2. Ground tripod and enclosures.

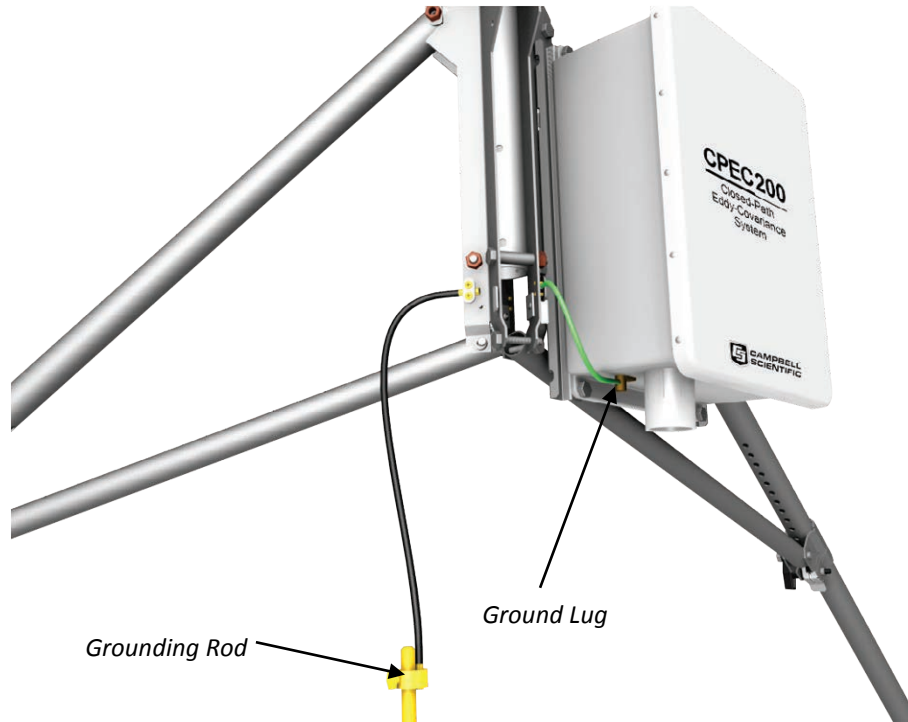

3. Setup tripod or mast with CM20X Crossarm.

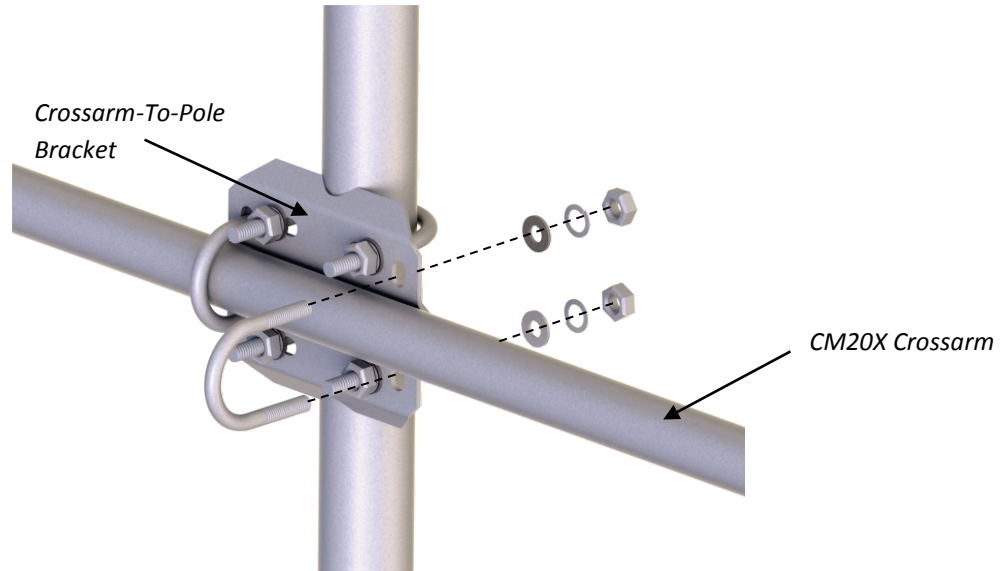

4. Mount the EC155 bypass tube.

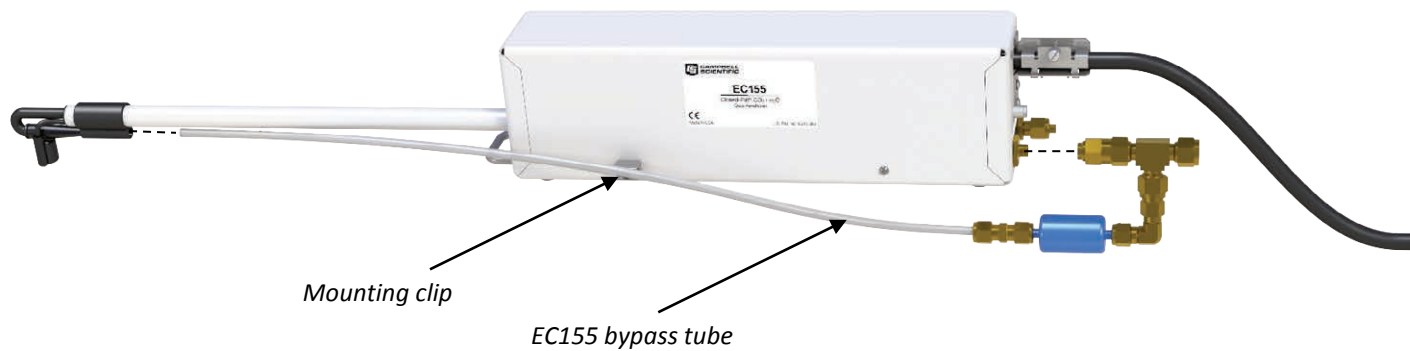

5. Mount gas analyzer and sonic anemometer.

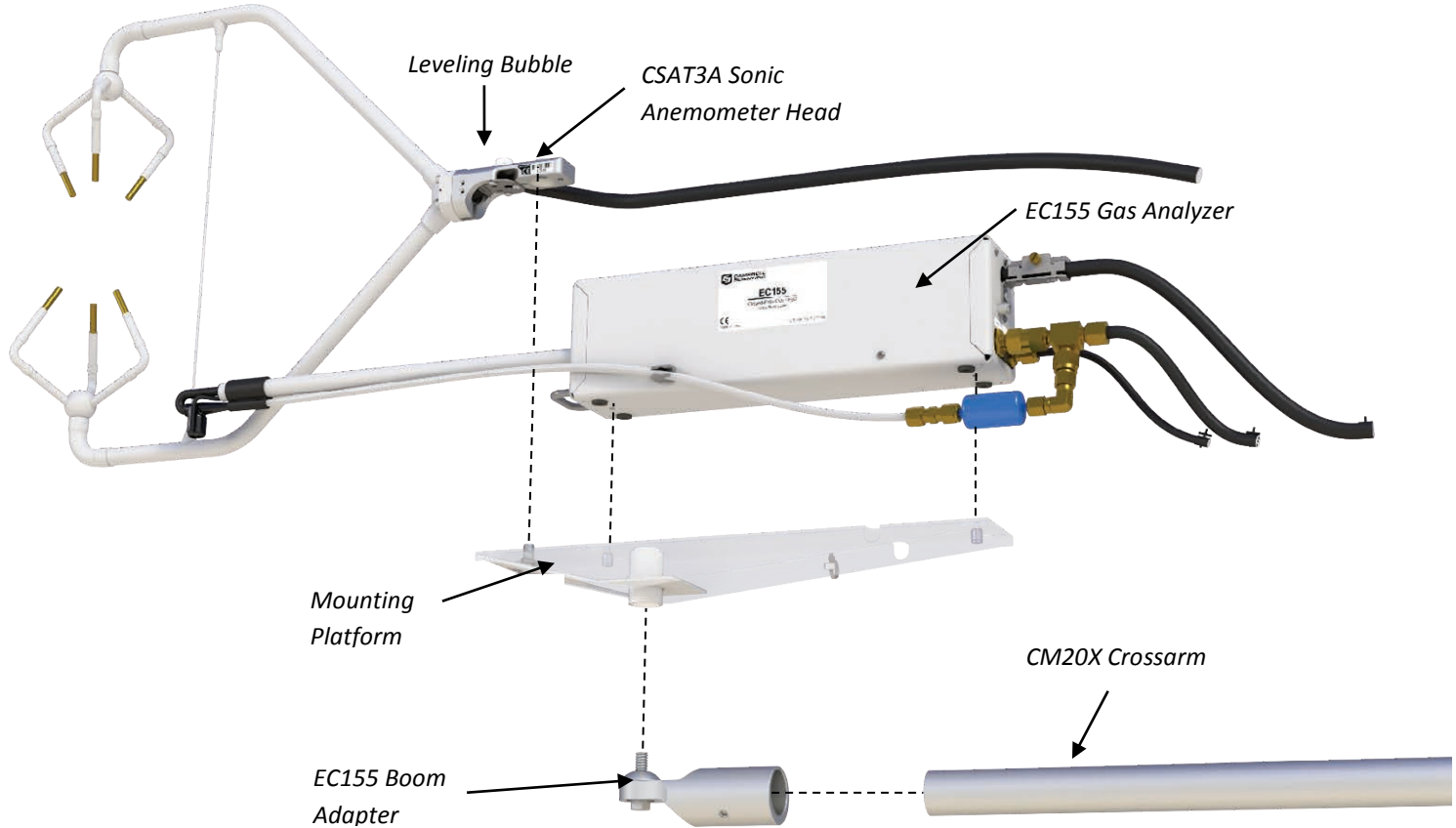

6. Connect EC155 and CSAT3A to EC100 Electronics.

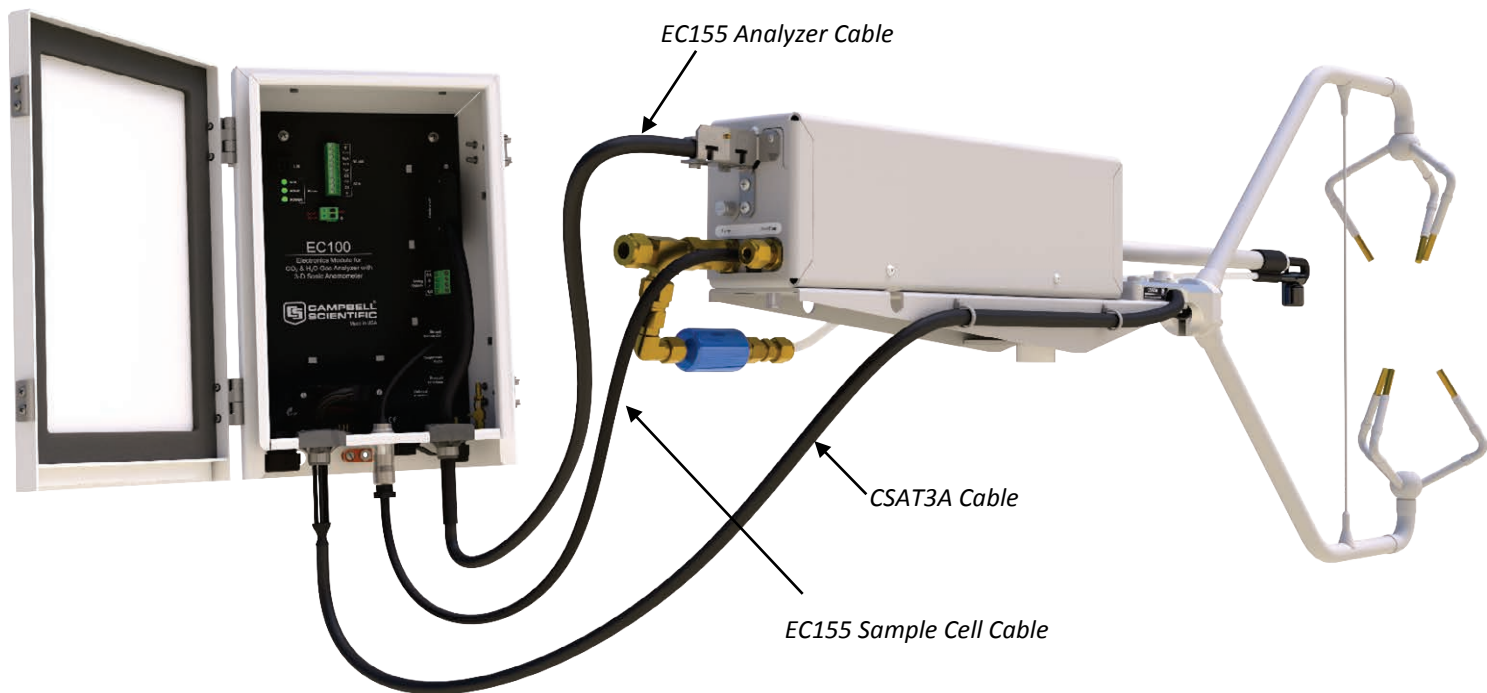

7. Connect system plumbing.

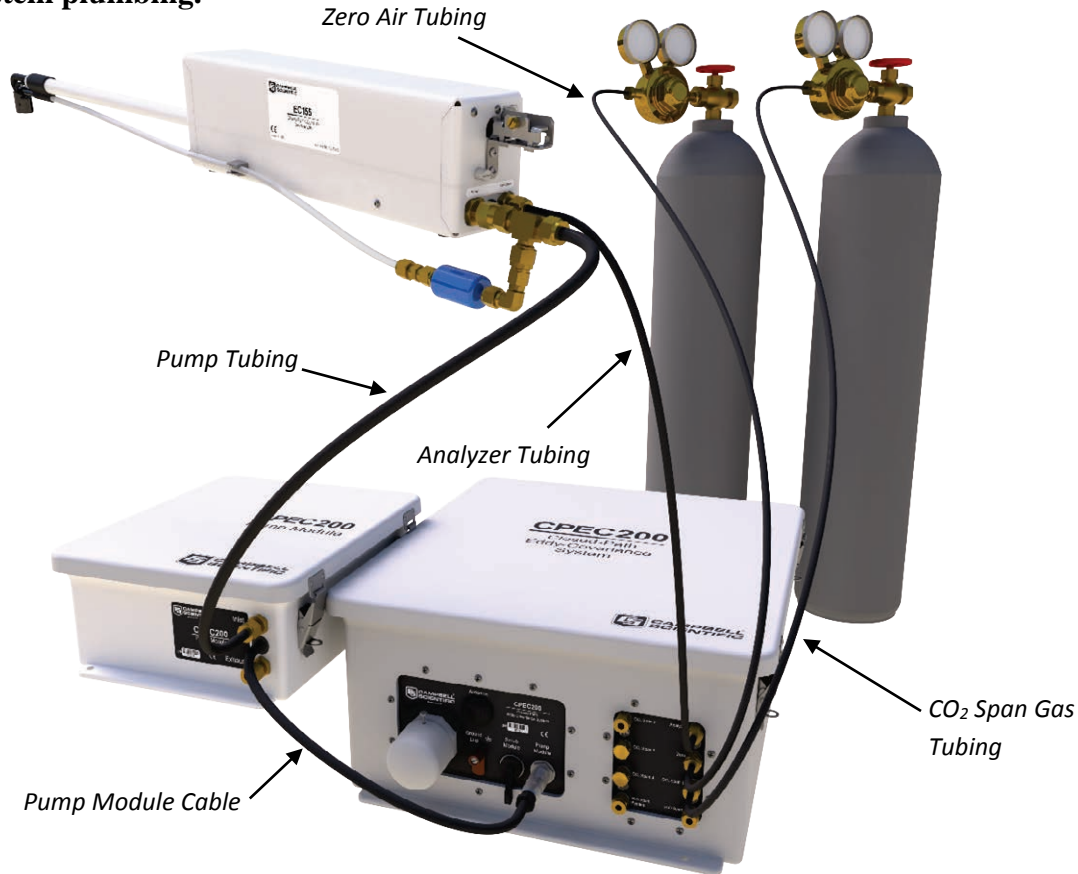

8. Connect system wiring and insert compact flash (CF) card.

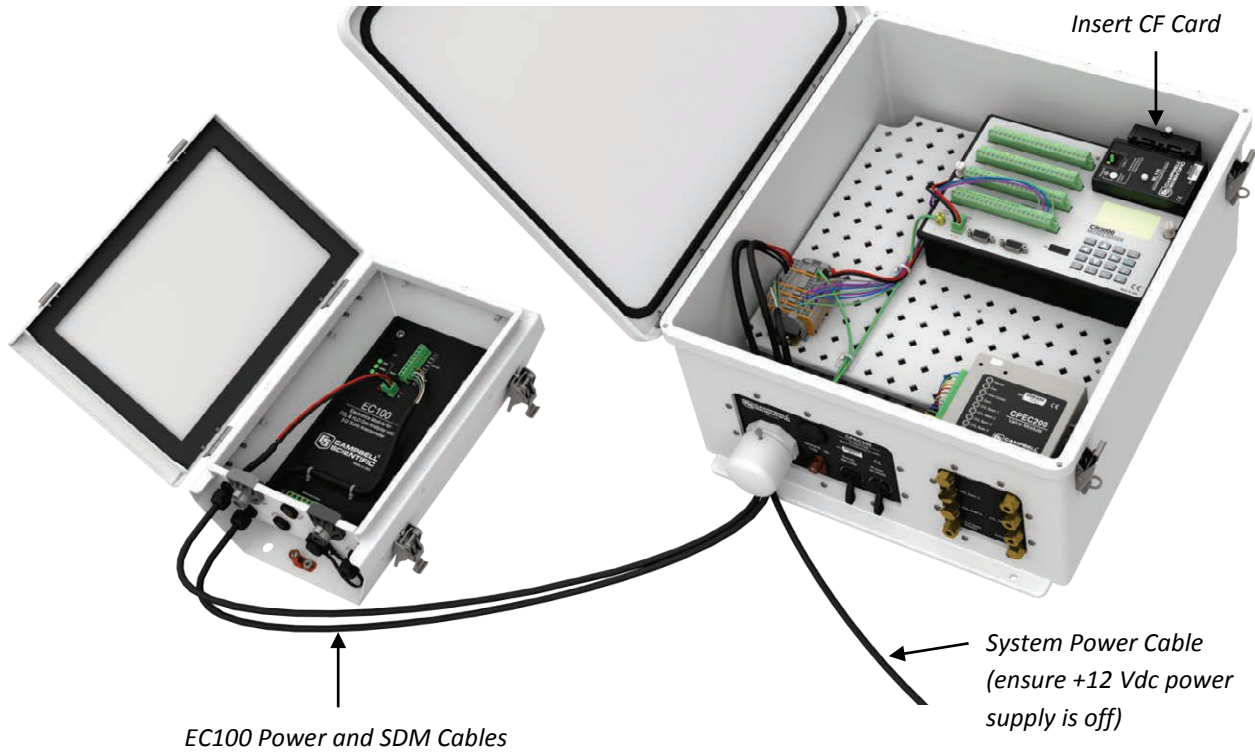

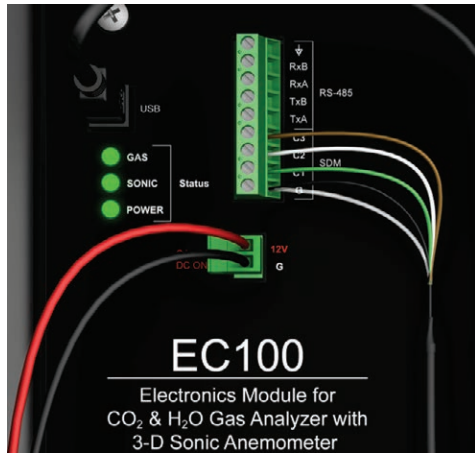

EC100
Power Cable

EC100 SDM
Cable

Power Cable to +12Vdc
Power Supply (off)

Power Cable
to EC100

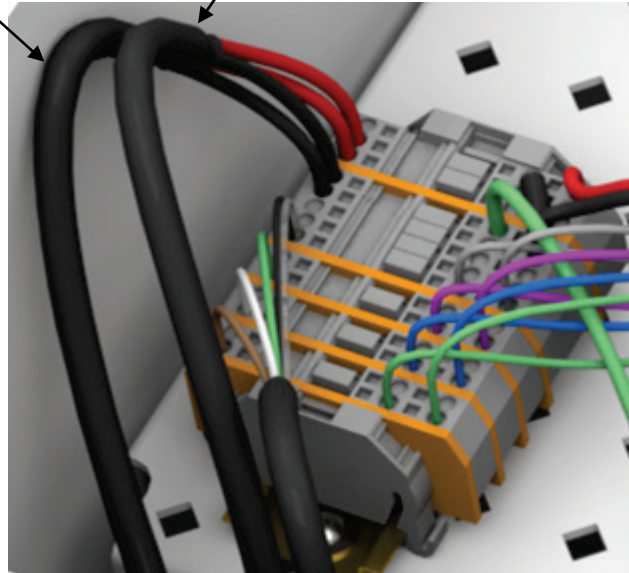

SDM Cable to EC100

9. Turn on the +12 Vdc power supply and use the datalogger keyboard display to set settings and initiate zero/span checks.

9.1 Press **Esc** to activate the display. Press **Enter** to display the System Control Menu.

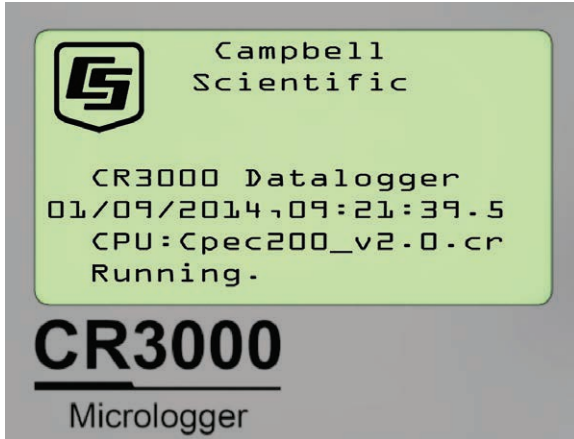

9.2 Select **Configure System**.

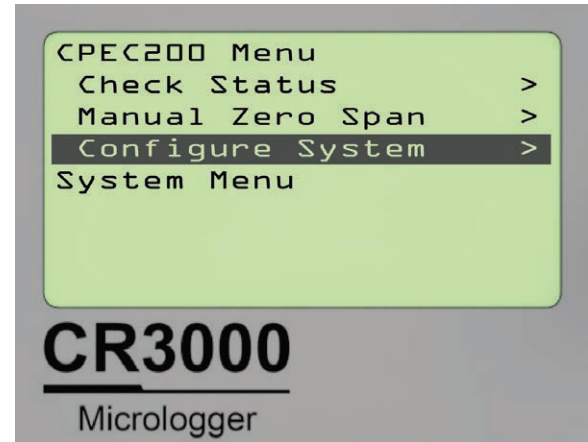

9.3 Select SONIC_AZIMU.

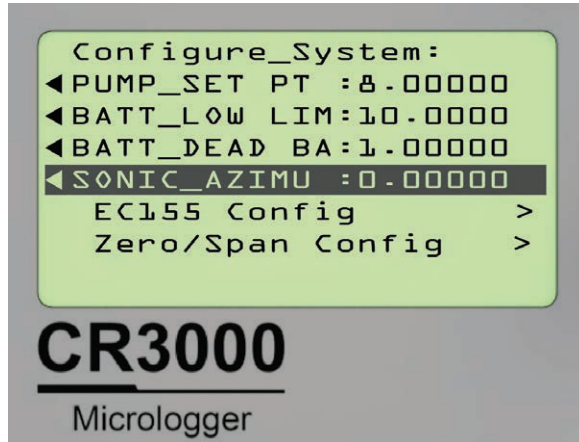

9.4 Enter the CSAT3A sonic head azimuth.

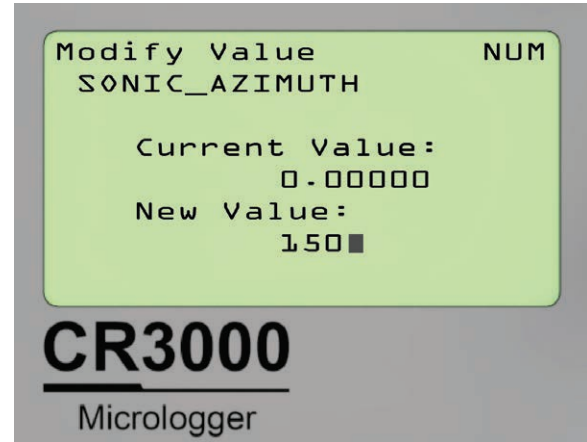

9.5 If the CPEC does not have a valve module, skip to 9.10. Otherwise, select **Zero/Span Config**.

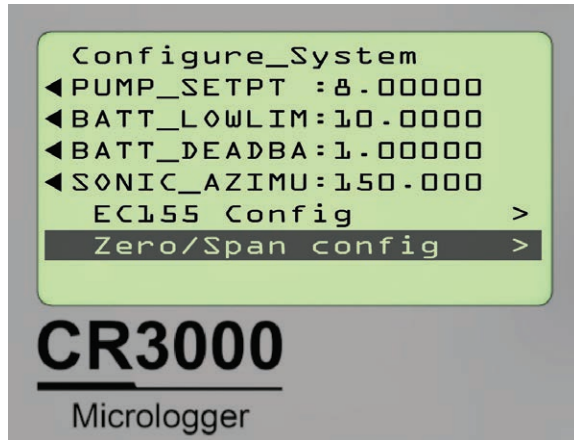

9.6 Select **CO2_SPAN_PPM**.

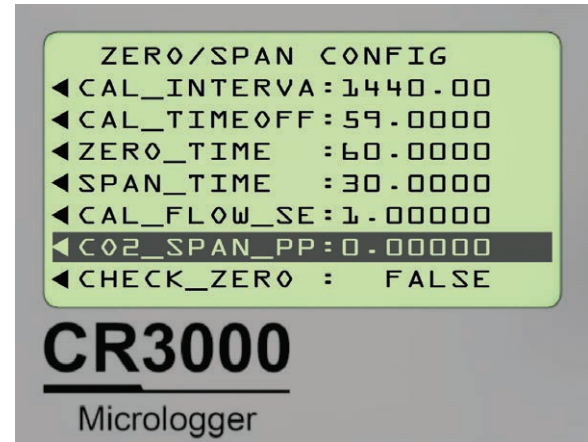

9.7 Set **CO2_SPAN_PPM** to match the CO₂ concentration of the CO₂ span gas tank.

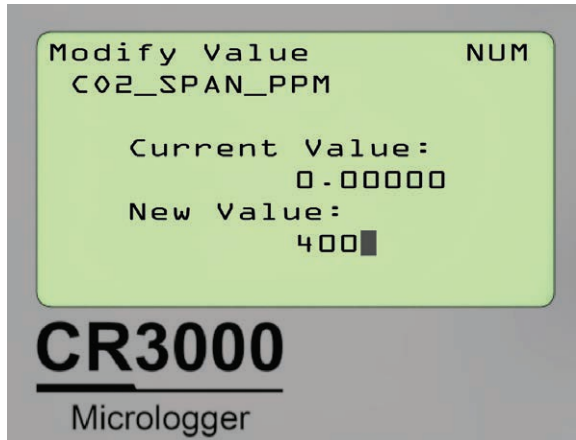

9.8 Select **CHECK_ZERO**, **SET_ZERO**, **CHECK_SPAN1**, **SET_SPAN1** in sequence. Leave **CHECK_SPAN2**, **CHECK_SPAN3**, and **CHECK_SPAN4** as *FALSE* unless the 6-valve module is being used.

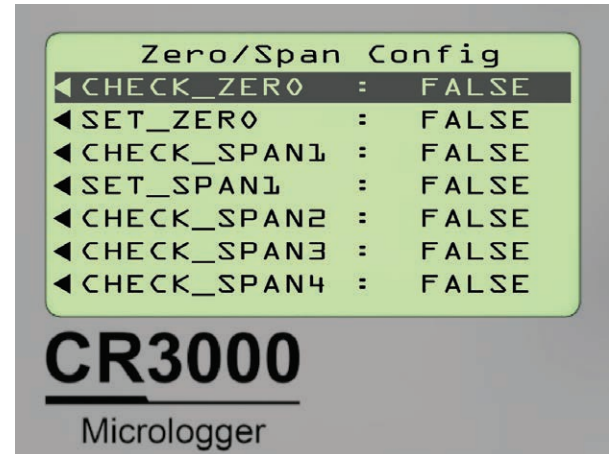

9.9 For each value selected on the previous screen, change the setting from *False* to *True* for **auto zero/span**.

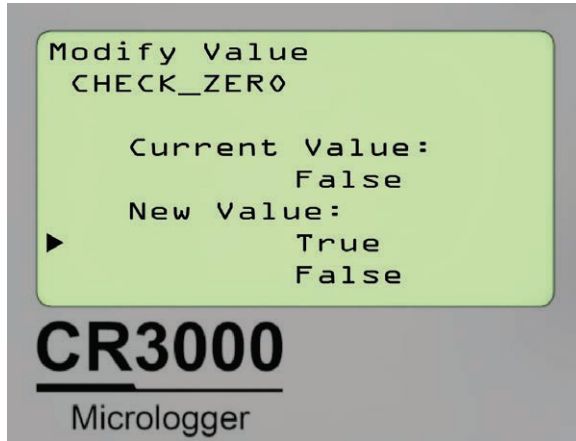

9.10 Press **ESC** to exit.

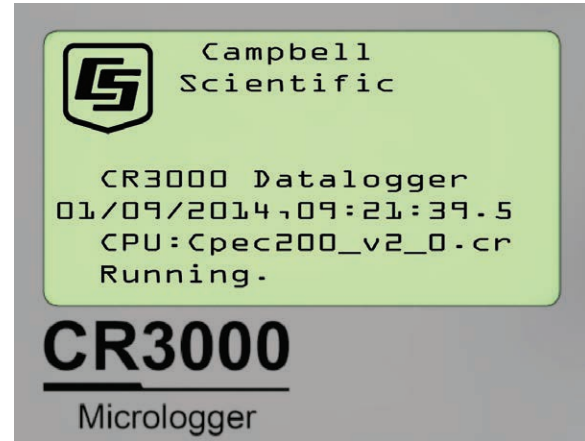

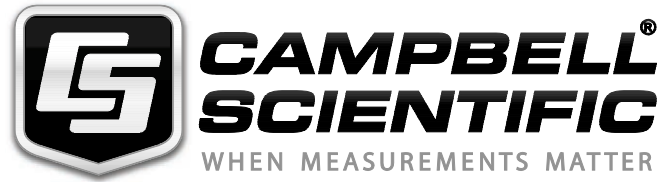

Please visit www.campbellsci.com to obtain contact information for your local US or International representative.