

# 253 and 257

---

## Soil Matric Potential Sensors

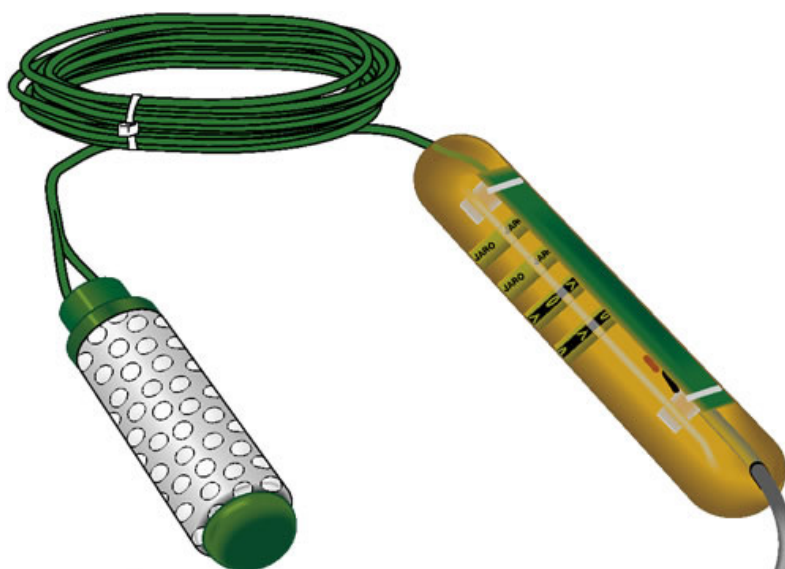

# **Limited Warranty**

---

“Products manufactured by CSI are warranted by CSI to be free from defects in materials and workmanship under normal use and service for twelve months from the date of shipment unless otherwise specified in the corresponding product manual. (Product manuals are available for review online at [www.campbellsci.com](http://www.campbellsci.com).) Products not manufactured by CSI, but that are resold by CSI, are warranted only to the limits extended by the original manufacturer. Batteries, fine-wire thermocouples, desiccant, and other consumables have no warranty. CSI’s obligation under this warranty is limited to repairing or replacing (at CSI’s option) defective Products, which shall be the sole and exclusive remedy under this warranty. The Customer assumes all costs of removing, reinstalling, and shipping defective Products to CSI. CSI will return such Products by surface carrier prepaid within the continental United States of America. To all other locations, CSI will return such Products best way CIP (port of entry) per Incoterms ® 2010. This warranty shall not apply to any Products which have been subjected to modification, misuse, neglect, improper service, accidents of nature, or shipping damage. This warranty is in lieu of all other warranties, expressed or implied. The warranty for installation services performed by CSI such as programming to customer specifications, electrical connections to Products manufactured by CSI, and Product specific training, is part of CSI’s product warranty. **CSI EXPRESSLY DISCLAIMS AND EXCLUDES ANY IMPLIED WARRANTIES OF MERCHANTABILITY OR FITNESS FOR A PARTICULAR PURPOSE. CSI hereby disclaims, to the fullest extent allowed by applicable law, any and all warranties and conditions with respect to the Products, whether express, implied or statutory, other than those expressly provided herein.**”

# Assistance

---

Products may not be returned without prior authorization. The following contact information is for US and international customers residing in countries served by Campbell Scientific, Inc. directly. Affiliate companies handle repairs for customers within their territories. Please visit [www.campbellsci.com](http://www.campbellsci.com) to determine which Campbell Scientific company serves your country.

To obtain a Returned Materials Authorization (RMA) number, contact CAMPBELL SCIENTIFIC, INC., phone (435) 227-9000. Please write the issued RMA number clearly on the outside of the shipping container. Campbell Scientific's shipping address is:

**CAMPBELL SCIENTIFIC, INC.**

RMA# \_\_\_\_\_  
815 West 1800 North  
Logan, Utah 84321-1784

For all returns, the customer must fill out a "Statement of Product Cleanliness and Decontamination" form and comply with the requirements specified in it. The form is available from our website at [www.campbellsci.com/repair](http://www.campbellsci.com/repair). A completed form must be either emailed to [repair@campbellsci.com](mailto:repair@campbellsci.com) or faxed to (435) 227-9106. Campbell Scientific is unable to process any returns until we receive this form. If the form is not received within three days of product receipt or is incomplete, the product will be returned to the customer at the customer's expense. Campbell Scientific reserves the right to refuse service on products that were exposed to contaminants that may cause health or safety concerns for our employees.

# Safety

---

**DANGER — MANY HAZARDS ARE ASSOCIATED WITH INSTALLING, USING, MAINTAINING, AND WORKING ON OR AROUND TRIPODS, TOWERS, AND ANY ATTACHMENTS TO TRIPODS AND TOWERS SUCH AS SENSORS, CROSSARMS, ENCLOSURES, ANTENNAS, ETC.** FAILURE TO PROPERLY AND COMPLETELY ASSEMBLE, INSTALL, OPERATE, USE, AND MAINTAIN TRIPODS, TOWERS, AND ATTACHMENTS, AND FAILURE TO HEED WARNINGS, INCREASES THE RISK OF DEATH, ACCIDENT, SERIOUS INJURY, PROPERTY DAMAGE, AND PRODUCT FAILURE. TAKE ALL REASONABLE PRECAUTIONS TO AVOID THESE HAZARDS. CHECK WITH YOUR ORGANIZATION'S SAFETY COORDINATOR (OR POLICY) FOR PROCEDURES AND REQUIRED PROTECTIVE EQUIPMENT PRIOR TO PERFORMING ANY WORK.

Use tripods, towers, and attachments to tripods and towers only for purposes for which they are designed. Do not exceed design limits. Be familiar and comply with all instructions provided in product manuals. Manuals are available at [www.campbellsci.com](http://www.campbellsci.com) or by telephoning (435) 227-9000 (USA). You are responsible for conformance with governing codes and regulations, including safety regulations, and the integrity and location of structures or land to which towers, tripods, and any attachments are attached. Installation sites should be evaluated and approved by a qualified engineer. If questions or concerns arise regarding installation, use, or maintenance of tripods, towers, attachments, or electrical connections, consult with a licensed and qualified engineer or electrician.

## General

- Prior to performing site or installation work, obtain required approvals and permits. Comply with all governing structure-height regulations, such as those of the FAA in the USA.
- Use only qualified personnel for installation, use, and maintenance of tripods and towers, and any attachments to tripods and towers. The use of licensed and qualified contractors is highly recommended.
- Read all applicable instructions carefully and understand procedures thoroughly before beginning work.
- Wear a **hardhat** and **eye protection**, and take **other appropriate safety precautions** while working on or around tripods and towers.
- **Do not climb** tripods or towers at any time, and prohibit climbing by other persons. Take reasonable precautions to secure tripod and tower sites from trespassers.
- Use only manufacturer recommended parts, materials, and tools.

## Utility and Electrical

- **You can be killed** or sustain serious bodily injury if the tripod, tower, or attachments you are installing, constructing, using, or maintaining, or a tool, stake, or anchor, come in **contact with overhead or underground utility lines**.
- Maintain a distance of at least one-and-one-half times structure height, 20 feet, or the distance required by applicable law, **whichever is greater**, between overhead utility lines and the structure (tripod, tower, attachments, or tools).
- Prior to performing site or installation work, inform all utility companies and have all underground utilities marked.
- Comply with all electrical codes. Electrical equipment and related grounding devices should be installed by a licensed and qualified electrician.

## Elevated Work and Weather

- Exercise extreme caution when performing elevated work.
- Use appropriate equipment and safety practices.
- During installation and maintenance, keep tower and tripod sites clear of un-trained or non-essential personnel. Take precautions to prevent elevated tools and objects from dropping.
- Do not perform any work in inclement weather, including wind, rain, snow, lightning, etc.

## Maintenance

- Periodically (at least yearly) check for wear and damage, including corrosion, stress cracks, frayed cables, loose cable clamps, cable tightness, etc. and take necessary corrective actions.
- Periodically (at least yearly) check electrical ground connections.

WHILE EVERY ATTEMPT IS MADE TO EMBODY THE HIGHEST DEGREE OF SAFETY IN ALL CAMPBELL SCIENTIFIC PRODUCTS, THE CUSTOMER ASSUMES ALL RISK FROM ANY INJURY RESULTING FROM IMPROPER INSTALLATION, USE, OR MAINTENANCE OF TRIPODS, TOWERS, OR ATTACHMENTS TO TRIPODS AND TOWERS SUCH AS SENSORS, CROSSARMS, ENCLOSURES, ANTENNAS, ETC.

# Table of Contents

---

PDF viewers: These page numbers refer to the printed version of this document. Use the PDF reader bookmarks tab for links to specific sections.

<b>1. Introduction.....</b>	<b>1</b>
<b>2. Precautions.....</b>	<b>1</b>
<b>3. Initial Inspection .....</b>	<b>1</b>
<b>4. QuickStart .....</b>	<b>2</b>
4.1.1 257 Short Cut Programming .....	2
4.1.2 253 Short Cut Programming .....	5
<b>5. Overview .....</b>	<b>8</b>
<b>6. Specifications .....</b>	<b>10</b>
<b>7. Operation .....</b>	<b>10</b>
7.1 Installation/Removal .....	10
7.2 Wiring .....	11
7.2.1 257 Wiring .....	11
7.2.2 253 Wiring .....	12
7.3 Programming.....	14
7.3.1 BRHalf Instruction.....	14
7.3.2 Calculations.....	15
7.3.2.1 Soil Water Matric Potential in Other Units .....	15
7.4 Interpreting Results .....	15
<b>8. Troubleshooting .....</b>	<b>16</b>
<b>9. Reference .....</b>	<b>16</b>
<b>Appendices</b>	
<b>A. Importing Short Cut Code Into CRBasic Editor... A-1</b>	
<b>B. Example Programs .....</b>	<b>B-1</b>
<b>Figures</b>	
5-1. 257 Soil Matric Potential Sensor with capacitor circuit and completion resistor installed in cable. Model 253 is the same, except that it does not have completion circuitry in the cable. ....	9
7-1. 257 schematic.....	12
7-2. 253 wiring example.....	13

**Tables**

7-1. 257 Wiring .....11  
7-2. 257-to AM16/32-series Multiplexer Wiring .....12  
7-3. Data Logger to AM16/32-series Multiplexer Wiring (2 x 32 Mode).13  
7-4. Excitation and Voltage Ranges for CRBasic Data Loggers .....14  
7-5. Conversion of Matric Potential to Other Units.....15  
B-1. 107/257 Wiring for Example Program.....B-1  
B-2. Wiring for 253 Example.....B-2

**CRBasic Examples**

B-1. CR6 Program Measuring a 107 and 257 .....B-1  
B-2. CR1000X Program Measuring Five 107s and Five 253s .....B-3

# 253 and 257 Soil Matric Potential Sensors

---

## 1. Introduction

The 253 and 257 soil matric potential sensors are solid-state, electrical-resistance sensing devices with a granular matrix that estimate soil water potential between 0 and –2 bars (typically wetter or irrigated soils).

The 253 needs to be connected to an AM16/32-series multiplexer, and is intended for applications where a larger number of sensors will be monitored. The 257 connects directly to our data loggers.

---

### NOTE

This manual provides information only for CRBasic data loggers. It is also compatible with our retired Edlog data loggers. For Edlog data logger support, see an older manual at [www.campbellsci.com/old-manuals](http://www.campbellsci.com/old-manuals).

---

## 2. Precautions

- READ AND UNDERSTAND the *Safety* section at the front of this manual.
- The black outer jacket of the cable is Santoprene® rubber. This jacket will support combustion in air. It is rated as slow burning when tested according to U.L. 94 H.B. and will pass FMVSS302. Local fire codes may preclude its use inside buildings.
- Avoid installing in depressions where water will puddle after a rain storm.
- Don't place the 253 or 257 in high spots or near changes in slope unless wanting to measure the variability created by such differences.
- When removing the sensor prior to harvest of annual crops, do so just after the last irrigation when the soil is moist.
- When removing a sensor, do not pull the sensor out by its wires.
- Careful removal prevents sensor and membrane damage.

## 3. Initial Inspection

- Upon receipt of a 253 or 257, inspect the packaging and contents for damage. File damage claims with the shipping company.
- The model number and cable length are printed on a label at the connection end of the cable. Check this information against the shipping documents to ensure the correct product and cable length are received.

## 4. QuickStart

A video that describes data logger programming using Short Cut is available at: [www.campbellsci.com/videos/cr1000x-datalogger-getting-started-program-part-3](http://www.campbellsci.com/videos/cr1000x-datalogger-getting-started-program-part-3). *Short Cut* is an easy way to program your data logger to measure the 253 or 257 and assign data logger wiring terminals. *Short Cut* is available as a download on [www.campbellsci.com](http://www.campbellsci.com). It is included in installations of *LoggerNet*, *PC200W*, *PC400*, or *RTDAQ*.

The following sections also describe programming with *Short Cut*.

### NOTE

*Short Cut* requires a soil temperature measurement before the 253 or 257 sensor is added. This is needed because there is a temperature correction factor in the equations that convert sensor resistance. In these Quickstart examples, a 107-L temperature probe is used to measure soil temperature.

### 4.1.1 257 Short Cut Programming

1. Open *Short Cut* and click **Create New Program**.
2. Double-click the data logger model.
3. In the **Available Sensors and Devices** box, type 107. You can also locate the sensor in the **Sensors > Temperature** folder. Double-click **107 Temperature Probe**. Use the default units of degree Celsius.

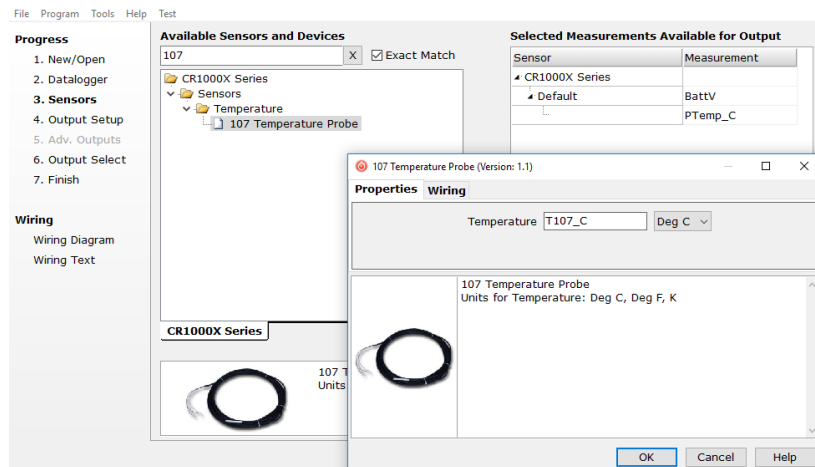



- Click on the **Wiring** tab to see how the sensor is to be wired to the data logger. Click **OK** after wiring the sensor.

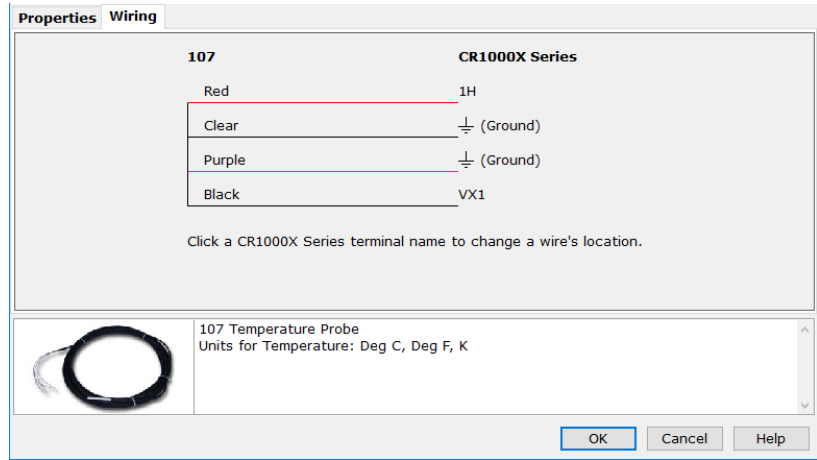

- In the **Available Sensors and Devices** box, type 257. You can also locate the sensor in the **Sensors > Meteorological > Soil Moisture** folder. Double-click **257 Soil Moisture Sensor**. Select the resistance units, soil water potential units, and soil reference temperature.

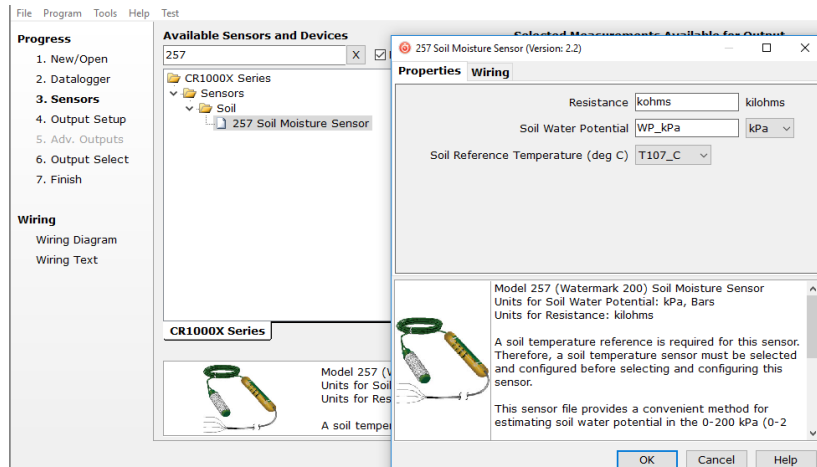

- Click on the **Wiring** tab to see how the sensor is to be wired to the data logger. Click **OK** after wiring the sensor.

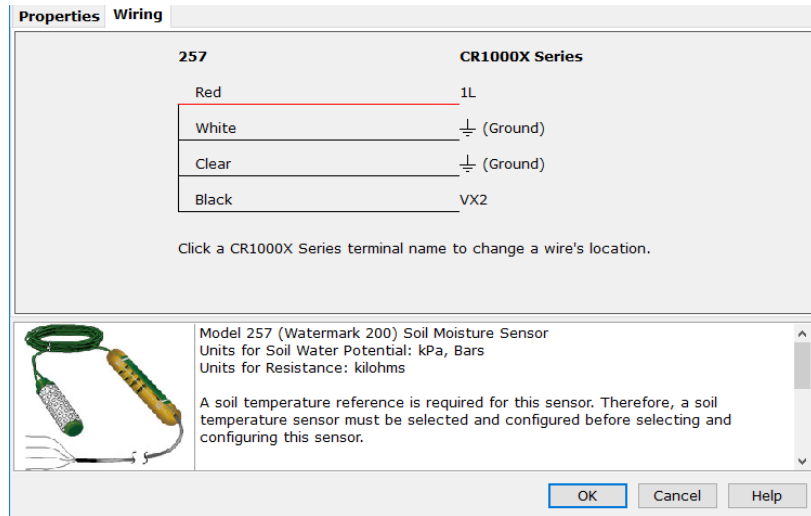

- In **Output Setup**, type the scan rate, meaningful table names, and the **Data Output Storage Interval**. Click **Next**.

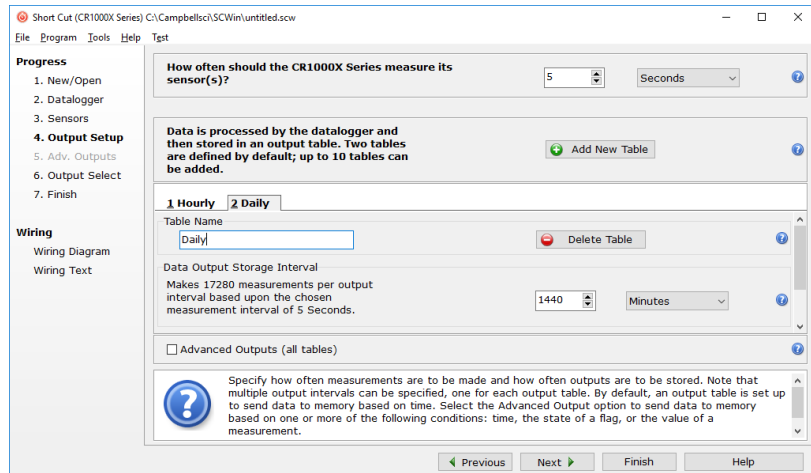

8. Select the output options.

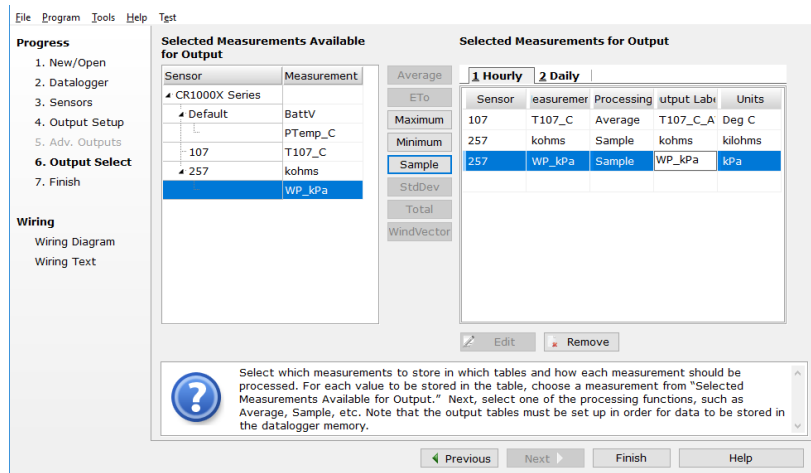

9. Click **Finish** and save the program. Send the program to the data logger if the data logger is connected to the computer.

10. If the sensor is connected to the data logger, check the output of the sensor in *LoggerNet*, *PC400*, *RTDAQ*, or *PC200W* to make sure it is making reasonable measurements.

### 4.1.2 253 Short Cut Programming

1. Follow steps 1 through 4 of Section 4.1.1, *257 Short Cut Programming* (p. 2).
2. In the **Available Sensors and Devices** box, type AM16/32. You can also locate the multiplexer in the **Device** folder.

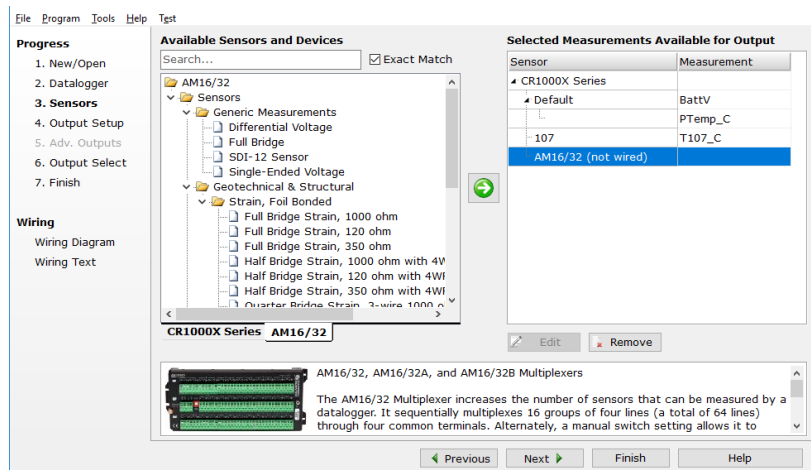

- In the **Available Sensors and Devices** box, type 253. You can also locate the sensor in the **Meteorological > Soil Moisture** folder. Double click the **253 Soil Moisture Sensor**. Select the number of sensors, resistance units, soil water potential units, and soil reference temperature.

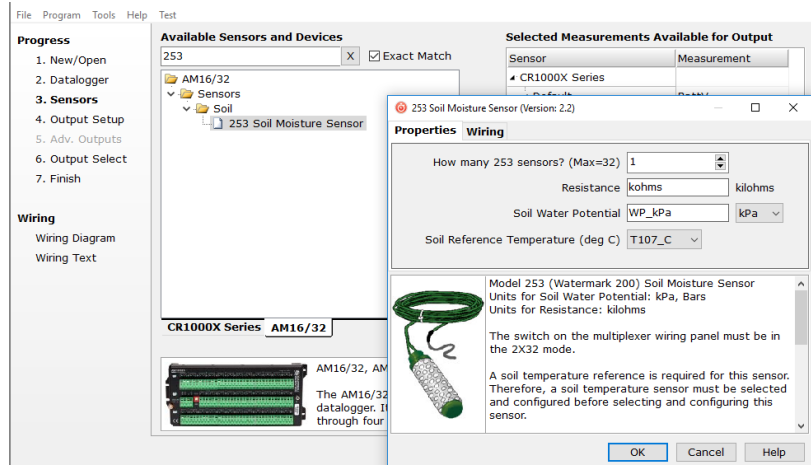

- Click on the **Wiring** tab to see how the sensor is to be wired to the AM16/32B. Click **OK** after wiring the sensor.

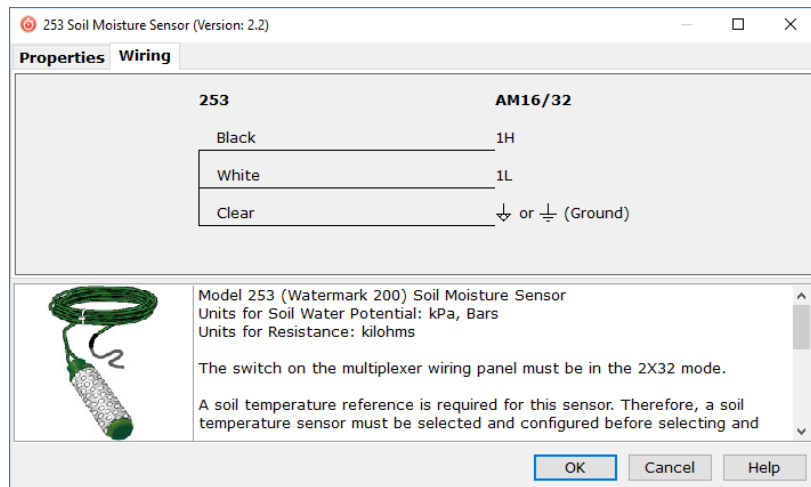

- In **Output Setup**, type a scan rate. When using a multiplexer, Campbell Scientific recommends a scan rate that is at least 30 s. Also type meaningful table names and the **Data Output Storage Interval**. Click **Next**.

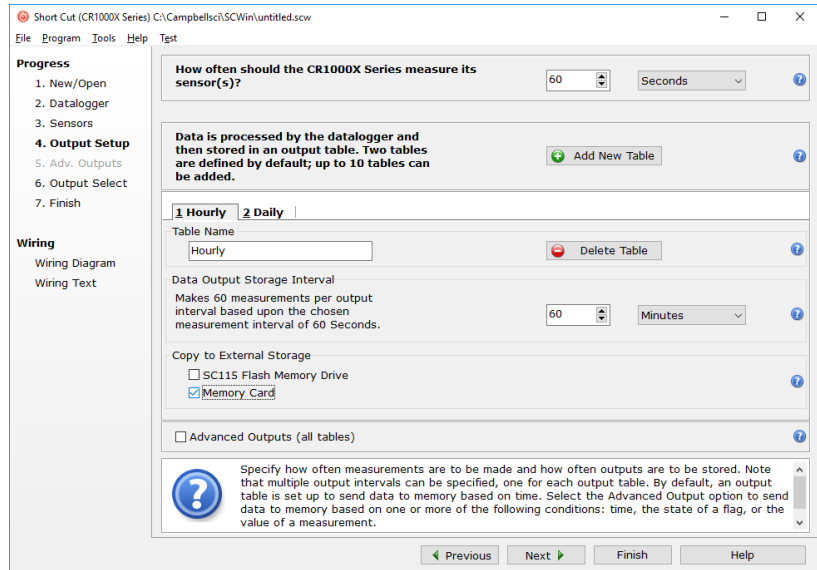

- Select the output options.

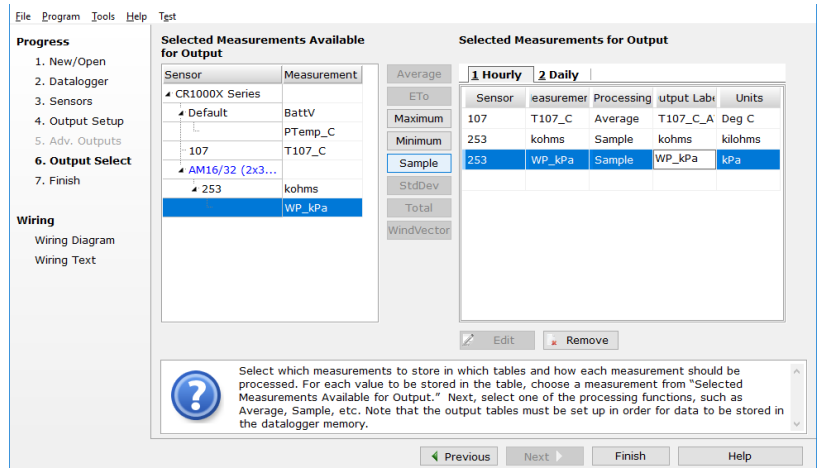

- Click the **Wiring Diagram** on the left side panel to see how the AM16/32B is to be wired to the data logger.

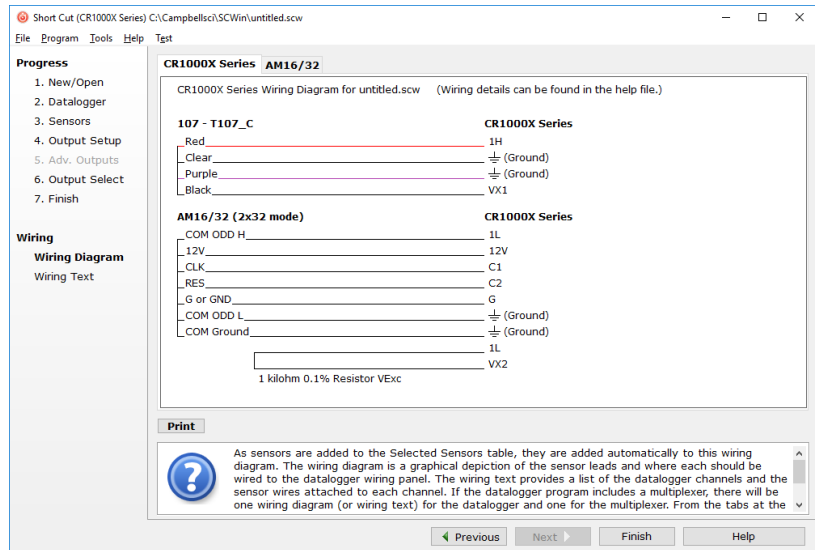

- Click **Finish** and save the program. Send the program to the data logger if the data logger is connected to the computer.
- If the sensor is connected to the data logger, check the output of the sensor in *LoggerNet*, *PC400*, *RTDAQ*, or *PC200W* to make sure it is making reasonable measurements.

## 5. Overview

The 253 and 257 soil matric potential sensors provide a convenient method of estimating water potential of wetter soils in the range of 0 to –200 kPa. The 253 is the Watermark 200 Soil Matric Potential Block modified for use with Campbell Scientific multiplexers and the 257 is the Watermark 200 Soil Matric Potential Block modified for use with Campbell Scientific data loggers.

The –L option on the Model 257-L and 253-L indicates that the cable length is user specified. This manual refers to the sensors as the 257 and 253. The typical cable length for the 257 is 25 ft.

For 253 applications, most of the cable length used is between the data logger and the multiplexer, which reduces overall cable costs and allows each cable attached to the 253 to be shorter. The cable length of each 253 only needs to cover the distance from the multiplexer to the point of measurement. Typical cable length for the 253 is 25 to 50 ft.

The difference between the 253 and the 257 is that there is a capacitor circuit and completion resistor installed in the 257 cable (FIGURE 5-1) to allow for direct connection to a data logger, while the 253 does not have any added circuitry. For applications requiring many sensors on an analog multiplexer, the 253 is used and one or more completion resistors are connected to the data logger wiring panel. A capacitor circuit is not required for the 253 on a multiplexer because the electrical connection between the sensor and the data logger is interrupted when the multiplexer is deactivated. Any potential

difference between the data logger earth ground and the electrodes in the sensor is thus eliminated.

The 253 and 257 consist of two concentric electrodes embedded in a reference granular matrix material. The granular matrix material is surrounded by a synthetic membrane for protection against deterioration. An internal gypsum tablet buffers against the salinity levels found in irrigated soils.

If cultivation practices allow, the sensor can be left in the soil all year, eliminating the need to remove the sensor during the winter months.

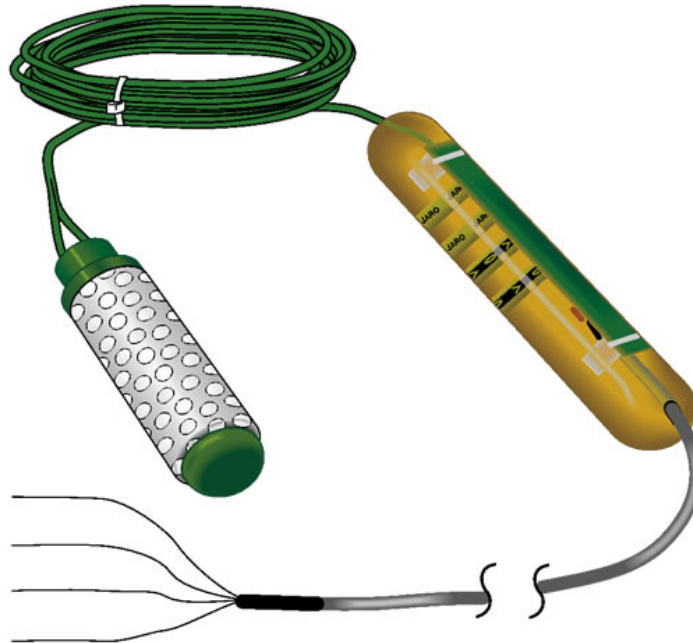

*FIGURE 5-1. 257 Soil Matric Potential Sensor with capacitor circuit and completion resistor installed in cable. Model 253 is the same, except that it does not have completion circuitry in the cable.*

## 6. Specifications

### Features:

- Survives freeze-thaw cycles
- Rugged, long-lasting sensor
- Buffers salts in soil
- No maintenance required
- 257 contains blocking capacitors in its cable that minimizes galvanic degradation and measurement errors due to ground loops
- For the 253, the multiplexer connection prevents electrolysis from prematurely destroying the probe
- Compatible with Campbell Scientific CRBasic data loggers: CR6, CR800-series, CR1000X, CR1000, CR3000, and CR5000

**Range:** 0 to –200 kPa

**Dimensions:** 8.26 cm (3.25 in)

**Diameter:** 1.91 cm (0.75 in)

**Weight:** 363 g (0.8 lb)

## 7. Operation

If you are programming your data logger with *Short Cut*, skip Section 7.2, *Wiring* (p. 11), and Section 7.3, *Programming* (p. 14). *Short Cut* does this work for you. See Section 4, *QuickStart* (p. 2), for a *Short Cut* tutorial.

### 7.1 Installation/Removal

#### NOTE

Placement of the sensor is important. To acquire representative measurements, avoid high spots, slope changes, or depressions where water puddles. Typically, the sensor should be located in the root system of the crop.

1. Soak sensors in water for one hour then allow them to dry, ideally for 1 to 2 days.
2. Repeat Step 1 twice if time permits.
3. Make the sensor access holes to the required depth. Often, a 22 mm (7/8 in) diameter rod can be used to make the hole. However, if the soil is very coarse or gravelly, an oversized hole (25 to 32 mm) may be required to prevent abrasion damage to the sensor membrane. The ideal method of making an oversized access hole is to have a stepped tool that makes an oversized hole for the upper portion and an exact size hole for the lower portion.
4. If the hole is oversized (25 to 32 mm), mix a slurry of soil and water to a creamy consistency and place it into the sensor access hole.



5. Insert the sensors in the sensor access hole. A length of 1/2 inch class 315 PVC pipe fits snugly over the sensor collar and can be used to push in the sensor. The PVC can be left in place with the wires threaded through the pipe and the open end taped shut (duct tape is adequate). This practice also simplifies the removal of the sensors. When using PVC piping, solvent weld the PVC pipe to the sensor collar. Use PVC/ABS cement on the stainless steel sensors with the green top. Use clear PVC cement only on the PVC sensors with the gray top.
6. Force the soil or slurry to envelope the sensors. This will ensure uniform soil contact.

**NOTE**

---

Snug fit in the soil is extremely important. Lack of a snug fit is the premier problem with sensor effectiveness.

---

7. Carefully, back fill the hole, and tamp down to prevent air pockets which could allow water to channel down to the sensor.
8. When removing sensors prior to harvest in annual crops, do so just after the last irrigation when the soil is moist.

**CAUTION**

---

Do not pull the sensor out by the wires. Careful removal prevents sensor and membrane damage.

---

9. When sensors are removed for winter storage, clean, dry, and place them in a plastic bag.

## 7.2 Wiring

### 7.2.1 257 Wiring

The 257 cable includes a capacitor circuit that stops galvanic action due to the differences in potential between the data logger earth ground and the electrodes in the block. This allows it to connect directly to a data logger (TABLE 7-1 and FIGURE 7-1).

**TABLE 7-1. 257 Wiring**

Wire Color	Wire Function	Data Logger Connection Terminal
Black	Voltage-excitation input	U configured for voltage excitation <sup>1</sup> , EX, VX (voltage excitation)
Red	Analog-voltage output	U configured for single-ended analog input <sup>1</sup> , SE (single-ended, analog-voltage input)
White	Negative signal	⊥ (analog ground)
Clear	Shield	⊥ (analog ground)

<sup>1</sup>U terminals are automatically configured by the measurement instruction.

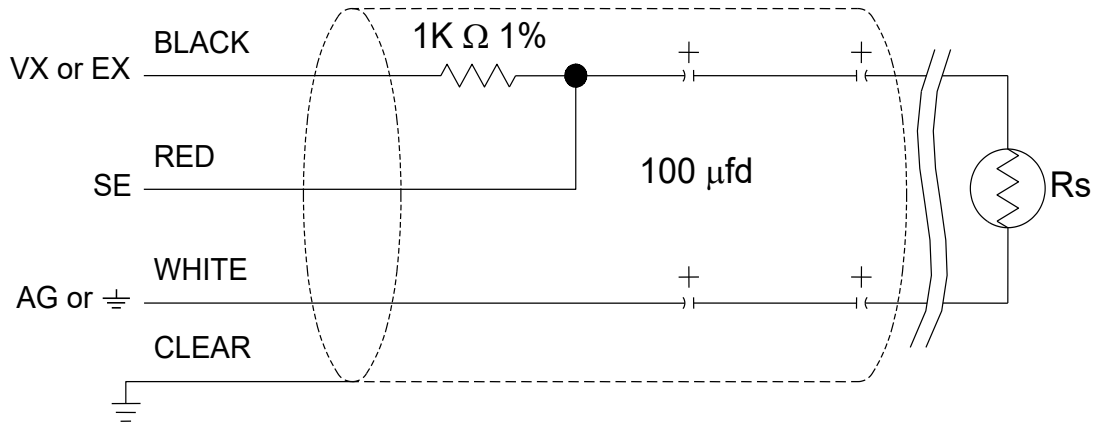

FIGURE 7-1. 257 schematic

### 7.2.2 253 Wiring

The 253 typically connects to an AM16/32-series multiplexer (TABLE 7-2), but it also is compatible with the long retired AM32 and AM416 multiplexers.

Wire Color	Wire Function	Multiplexer Connection Terminal
White	Voltage-excitation input	H
Black	Analog-voltage output	L
Clear	Shield	▽ or ⊥ (ground)

The multiplexer connects to the data logger (refer to the multiplexer manual or [www.campbellsci.com/am16-32b-ordering](http://www.campbellsci.com/am16-32b-ordering) for information on the cables available for connecting the multiplexer to the data logger). A 1000 ohm resistor at the data logger wiring panel is used to complete the half bridge circuitry.

TABLE 7-3 and FIGURE 7-2 show the data logger-to-multiplexer connections for the 2 x 32 mode. TABLE B-2, *Wiring for 253 Example (B-2)*, shows wiring for the 4 x 16 mode.

TABLE 7-3. Data Logger to AM16/32-series Multiplexer Wiring (2 x 32 Mode)	
Data Logger Connection Terminal	Multiplexer Connection Terminal
12V	12V
G	G
C (control terminal)	RES
C (control terminal)	CLK
U configured for voltage excitation <sup>1</sup> , EX, VX (voltage excitation)	
U configured for single-ended analog terminal <sup>1</sup> , SE (single-ended, analog-voltage terminal)	COM ODD H
⊥ (analog ground)	COM ODD L
⊥ (analog ground)	COM ⊕ or ⊥ (ground)
<sup>1</sup> U terminals are automatically configured by the measurement instruction.	

1000 Ω resistor

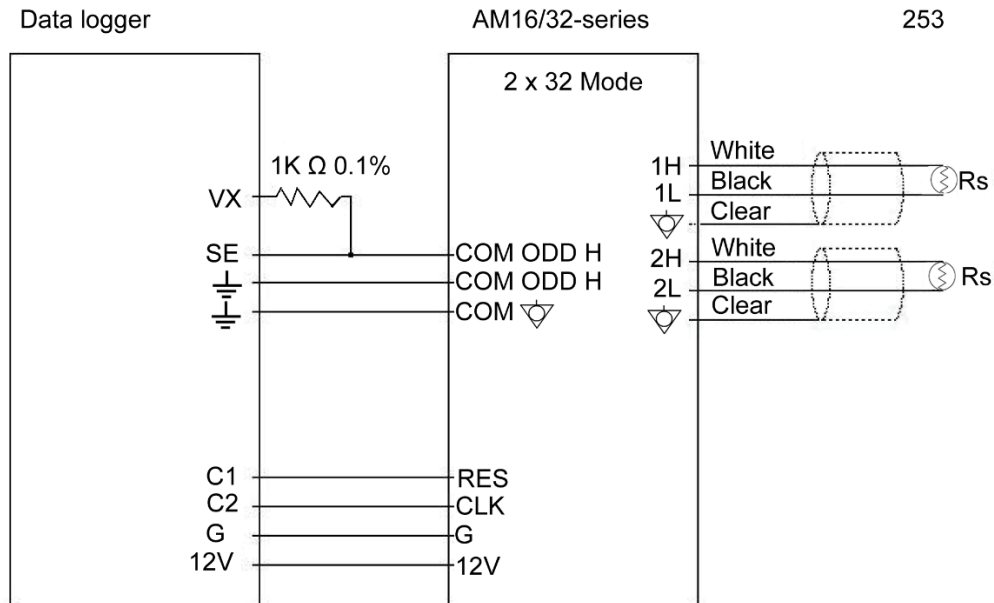

FIGURE 7-2. 253 wiring example

## 7.3 Programming

*Short Cut* is the best source for up-to-date data logger programming code.

If your data acquisition requirements are simple, you can probably create and maintain a data logger program exclusively with *Short Cut*. If your data acquisition needs are more complex, the files that *Short Cut* creates are a great source for programming code to start a new program or add to an existing custom program.

### NOTE

*Short Cut* cannot edit programs after they are imported and edited in *CRBasic Editor*.

A *Short Cut* tutorial is available in Section 4, *QuickStart* (p. 2). If you wish to import *Short Cut* code into *CRBasic Editor* to create or add to a customized program, follow the procedure in Appendix A, *Importing Short Cut Code Into CRBasic Editor* (p. A-1).

Programming basics for CRBasic data loggers are in the following sections. Complete program examples for select CRBasic data loggers can be found in Appendix B, *Example Programs* (p. B-1). Programming basics and programming examples for Edlog data loggers are provided at [www.campbellsci.com/old-manuals](http://www.campbellsci.com/old-manuals).

### 7.3.1 BRHalf Instruction

CRBasic data loggers use the **BRHalf()** instruction with the *RevEx* argument set to *True* to excite and measure the 253 and 257. The result of the **BRHalf()** instruction is the ratio of the measured voltage divided by the excitation voltage. The result needs to be converted to resistance and then converted to soil water potential.

TABLE 7-4 shows the excitation and voltage ranges used with the CRBasic data loggers.

<b>Data Logger</b>	<b>mV excitation</b>	<b>Full Scale Range</b>
CR800 Series	250	± 250 mV
CR6	200	± 200 mV
CR1000X	200	± 200 mV
CR1000	250	± 250 mV
CR3000	200	± 200 mV
CR5000	200	± 200 mV

### 7.3.2 Calculations

The CRBasic program should include the following to calculate resistance, adjust the resistance for soil temperature, and calculate soil water potential:

```

kohms=kohms/(1-kohms)
kohms=(100+(1.8*T107_C+32)-69.8)/100*kohms
If kohms<=1 Then
  WP_kPa=-(20*kohms-11)
Else
  WP_kPa=-(-0.00279*kohms^3+0.19109*kohms^2+3.71485*kohms+6.73956)
EndIf

```

where,

kohms = the variable storing the **BRHalf()** result

T107\_C = the variable storing the temperature sensor measurement (degree Celsius)

WP\_kPa = water potential

#### 7.3.2.1 Soil Water Matric Potential in Other Units

To report measurement results in other units, multiply the soil water potential by the appropriate conversion constant from TABLE 7-5.

<b>Desired Unit</b>	<b>Multiply Result By</b>
kPa	1.0
MPa	0.001
Bar	0.01

## 7.4 Interpreting Results

As a general guide, 253 and 257 measurements indicate soil matric potential as follows:

- 0 to -10 kPa = Saturated soil
- 10 to -20 kPa = Soil is adequately wet (except coarse sands, which are beginning to lose water).
- 20 to -60 kPa = Usual range for irrigation (except heavy clay).
- 60 to -100 kPa = Usual range for irrigation for heavy clay soils.
- 100 to -200 kPa = Soil is becoming dangerously dry for maximum production.

## 8. Troubleshooting

**NOTE**

All factory repairs and recalibrations require a returned material authorization (RMA) and completion of the “Declaration of Hazardous Material and Decontamination” form. Refer to the [Assistance](#) page at the beginning of this manual for more information.

---

To test the sensor, submerge it in water. Measurements should be from -3 to +3 kPa. Let the sensor dry for 30 to 48 hours. You should see the reading increase from 0 to 150+ kPa. If the reading does not increase to 150 kPa, replace the sensor. If the reading increases as expected, put the sensor back in the water. The reading should run right back down to zero in 1 to 2 minutes.

If the sensor passes these tests but it is still not functioning properly, consider the following:

1. Sensor may not have a snug fit in the soil. This usually happens when an oversized access hole has been used and the backfilling of the area around the sensor is not complete.
2. Sensor is not in an active portion of the root system, or the irrigation is not reaching the sensor area. This can happen if the sensor is sitting on top of a rock or below a hard pan which may impede water movement. Re-installing the sensor usually solves this problem.
3. When the soil dries out to the point where you are seeing readings higher than 80 kPa, the contact between soil and sensor can be lost because the soil may start to shrink away from the sensor. An irrigation which only results in a partial rewetting of the soil will not fully rewet the sensor, which can result in continued high readings from the 257. Full rewetting of the soil and sensor usually restores soil to sensor contact. This is most often seen in the heavier soils and during peak crop water demand when irrigation may not be fully adequate. The plotting of readings on a chart is most useful in getting a good picture of this sort of behavior.

## 9. Reference

Thompson, S.J. and C.F. Armstrong, Calibration of the Watermark Model 200 Soil matric potential Sensor, Applied Engineering in Agriculture, Vol. 3, No. 2, pp. 186-189, 1987.

Parts of this manual were contributed by Irrrometer Company, Inc., manufacturer of the Watermark 200.

# Appendix A. Importing Short Cut Code Into CRBasic Editor

---

*Short Cut* creates a .DEF file that contains wiring information and a program file that can be imported into the *CRBasic Editor*. By default, these files reside in the C:\campbellsci\SCWin folder.

Import *Short Cut* program file and wiring information into *CRBasic Editor*:

1. Create the *Short Cut* program following the procedure in Section 4, *QuickStart* (p. 2). After saving the *Short Cut* program, click the **Advanced** tab then the **CRBasic Editor** button. A program file with a generic name will open in CRBasic. Provide a meaningful name and save the CRBasic program. This program can now be edited for additional refinement.

---

## NOTE

Once the file is edited with *CRBasic Editor*, *Short Cut* can no longer be used to edit the program it created.

---

2. To add the *Short Cut* wiring information into the new CRBasic program, open the .DEF file located in the C:\campbellsci\SCWin folder, and copy the wiring information, which is at the beginning of the .DEF file.
3. Go into the CRBasic program and paste the wiring information into it.
4. In the CRBasic program, highlight the wiring information, right-click, and select **Comment Block**. This adds an apostrophe (') to the beginning of each of the highlighted lines, which instructs the data logger compiler to ignore those lines when compiling. The **Comment Block** feature is demonstrated at about 5:10 in the [CRBasic | Features](#) video .

# Appendix B. Example Programs

CRBasic Example B-1 measures the resistance (kΩ) of one 257 sensor with the data logger. A 107 temperature probe is measured first for temperature correction of the 257 reading. Voltage range codes for other CRBasic data loggers are shown in TABLE 7-4. Sensor wiring for this example is shown in TABLE B-1.

Sensor	Wire	Function	CR6
107	Black	Excitation	U1
	Red	Positive Signal	U2
	Purple	Negative Signal	⊥
	Clear	Shield	⊥
257	Black	Excitation	U4
	Red	Positive Signal	U3
	White	Negative Signal	⊥
	Clear	Shield	⊥

CRBasic Example B-1. CR6 Program Measuring a 107 and 257

```
'CR6 Series

'Declare Variables and Units
Public T107_C
Public kohms
Public WP_kPa

Units T107_C=Deg C
Units kohms=kilohms
Units WP_kPa=kPa

'Define Data Tables
DataTable(Table1,True,-1)
  DataInterval(0,60,Min,10)
  Average(1,T107_C,FP2,False)
  Sample(1,WP_kPa,FP2)
EndTable

'Main Program
BeginProg
'Main Scan
Scan(5,Sec,1,0)
  '107 Temperature Probe measurement 'T107_C'
  Therm107(T107_C,1,U2,U1,0,60,1,0)
  '257 Soil Moisture Sensor measurements 'kohms' and 'WP_kPa'
  BrHalf(kohms,1,mV200,U3,U4,1,200,True,0,15000,1,0)
  kohms=kohms/(1-kohms)
  kohms=(100+(1.8*T107_C+32)-69.8)/100*kohms
  If kohms<=1 Then
    WP_kPa=- (20*kohms-11)
  Else
```



```

WP_kPa=-(-0.00279*kohms^3+0.19109*kohms^2+3.71485*kohms+6.73956)
EndIf
'Call Data Tables and Store Data
CallTable Table1
NextScan
EndProg
    
```

CRBasic Example B-2 measures five 107 temperature probes and five 253 sensors on an AM16/32-series multiplexer (4x16 mode) with the CR1000X data logger. In this example, a 107 temperature probe is buried at the same depth as a corresponding 253 sensor. Voltage range codes for other CRBasic data loggers are shown in TABLE 7-4. Sensor wiring is shown in TABLE B-2.

TABLE B-2. Wiring for 253 Example				
CR1000X	AM16/32B	Sensor	Wire	Function
12V	12V			
G	G			
C1	RES			
C2	CLK			
VX1	COM ODD H			
SE1 (1H)	COM ODD L			
Ground	COM GROUND			
SE2 (1L)	COM EVEN H			
Ground	COM EVEN L			
1000 ohm resistor from SE2 to VX2				
	1H	107	Black	Excitation
	1L		Red	Positive Signal
	⊥		Purple	Negative Signal
	⊥		Clear	Shield
	2H	253	White	Positive Signal
	2L		Black	Negative Signal
	⊥		Clear	Shield
Continue wiring sensors to multiplexer with 107 probes attaching to odd numbered terminals and 253 sensors to even numbered terminals. AM16/32B in 4x16 mode.				

**CRBasic Example B-2. CR1000X Program Measuring Five 107s and Five 253s**

```

'CR1000X
Public T107_C(5), WP_kPa(5), kOhms(5)
Dim i

Units T107_C()=Deg C
Units kOhms()=kOhms
Units WP_kPa()=kPa

DataTable(Hourly,true,-1)
  DataInterval(0,60,Min,10)
  Average(5, T107_C, FP2, 0)
  Sample(5, WP_kPa, FP2)
  Sample(5, kOhms, FP2)
EndTable

BeginProg
Scan(60,Sec, 3, 0)
  PortSet(C1,1) 'Turn AM16/32 Multiplexer On
  Delay(0,150,mSec)
  i = 1
  SubScan (0,uSec,5)
    PulsePort(C2,10000)
    'Soil temperature measurement
    Therm107(T107_C(i),1,1,VX1,0,60,1,0)
    '253 Soil Moisture Sensor measurements
    BrHalf(kOhms(i),1,mV200,2,VX2,1,200,true,0,60,1,0)
    'Convert resistance ratios to kOhms
    kOhms(i) = kOhms(i)/(1-kOhms(i))
    kOhms(i)=(100+(1.8*T107_C(i)+32)-69.8)/100*kOhms(i)
    i = i+1
  NextSubScan
  PortSet(C1,0) 'Turn AM16/32 Multiplexer Off
  'Convert kOhms to water potential
  For i = 1 To 5
    If kOhms(i)<=1 Then
      WP_kPa(i)=- (20*kOhms(i)-11)
    Else
      WP_kPa(i)=- (-0.00279*kOhms(i)^3+0.19109*kOhms(i)^2+3.71485*kOhms(i)+6.73956)
    EndIf
  Next i
  CallTable Hourly 'Call Data Table and Store Data
NextScan
EndProg

```



# Global Sales & Support Network

A worldwide network to help meet your needs



● Campbell Scientific Regional Offices

● Sales Representatives

## Australia

*Location:* Garbutt, QLD Australia  
*Phone:* 61.7.4401.7700  
*Email:* [info@campbellsci.com.au](mailto:info@campbellsci.com.au)  
*Website:* [www.campbellsci.com.au](http://www.campbellsci.com.au)

## Brazil

*Location:* São Paulo, SP Brazil  
*Phone:* 11.3732.3399  
*Email:* [vendas@campbellsci.com.br](mailto:vendas@campbellsci.com.br)  
*Website:* [www.campbellsci.com.br](http://www.campbellsci.com.br)

## Canada

*Location:* Edmonton, AB Canada  
*Phone:* 780.454.2505  
*Email:* [dataloggers@campbellsci.ca](mailto:dataloggers@campbellsci.ca)  
*Website:* [www.campbellsci.ca](http://www.campbellsci.ca)

## China

*Location:* Beijing, P. R. China  
*Phone:* 86.10.6561.0080  
*Email:* [info@campbellsci.com.cn](mailto:info@campbellsci.com.cn)  
*Website:* [www.campbellsci.com](http://www.campbellsci.com)

## Costa Rica

*Location:* San Pedro, Costa Rica  
*Phone:* 506.2280.1564  
*Email:* [info@campbellsci.cc](mailto:info@campbellsci.cc)  
*Website:* [www.campbellsci.cc](http://www.campbellsci.cc)

## France

*Location:* Vincennes, France  
*Phone:* 0033.0.1.56.45.15.20  
*Email:* [info@campbellsci.fr](mailto:info@campbellsci.fr)  
*Website:* [www.campbellsci.fr](http://www.campbellsci.fr)

## Germany

*Location:* Bremen, Germany  
*Phone:* 49.0.421.460974.0  
*Email:* [info@campbellsci.de](mailto:info@campbellsci.de)  
*Website:* [www.campbellsci.de](http://www.campbellsci.de)

## South Africa

*Location:* Stellenbosch, South Africa  
*Phone:* 27.21.8809960  
*Email:* [sales@campbellsci.co.za](mailto:sales@campbellsci.co.za)  
*Website:* [www.campbellsci.co.za](http://www.campbellsci.co.za)

## Southeast Asia

*Location:* Bangkok, Thailand  
*Phone:* 66.2.719.3399  
*Email:* [thitipongc@campbellsci.asia](mailto:thitipongc@campbellsci.asia)  
*Website:* [www.campbellsci.asia](http://www.campbellsci.asia)

## Spain

*Location:* Barcelona, Spain  
*Phone:* 34.93.2323938  
*Email:* [info@campbellsci.es](mailto:info@campbellsci.es)  
*Website:* [www.campbellsci.es](http://www.campbellsci.es)

## UK

*Location:* Shephed, Loughborough, UK  
*Phone:* 44.0.1509.601141  
*Email:* [sales@campbellsci.co.uk](mailto:sales@campbellsci.co.uk)  
*Website:* [www.campbellsci.co.uk](http://www.campbellsci.co.uk)

## USA

*Location:* Logan, UT USA  
*Phone:* 435.227.9120  
*Email:* [info@campbellsci.com](mailto:info@campbellsci.com)  
*Website:* [www.campbellsci.com](http://www.campbellsci.com)